

**INTER-MUNICIPAL AGREEMENT
CITY OF CHICO WASTEWATER TREATMENT SERVICES TO THE
TOWN OF PARADISE**

**APPROVED BY TOWN OF PARADISE TOWN COUNCIL FEBRUARY 14, 2023
APPROVED BY CITY OF CHICO CITY COUNCIL FEBRUARY 21, 2023**

THIS INTER-MUNICIPAL AGREEMENT (“Agreement”) is made and entered into on 3-8-2023 by and between the TOWN OF PARADISE, a municipal corporation (Town) and the CITY OF CHICO, a municipal corporation (City). Each may be referred to as a Party and together as the Parties.

RECITALS

1. The Town of Paradise experiences public health and safety risks as a result of its failed or failing sewer system and has sought a solution for some time, as detailed in the Program EIR for the Paradise Sewer Project.
2. Through its work on the Paradise Sewer Project (Project), the Town of Paradise (Town) identified a connection to the Chico Water Pollution Control Plant (WPCP) as its preferred alternative for wastewater treatment and disposal and approached the City of Chico (City) to explore the feasibility of such a connection.
3. The Project improves groundwater quality and facilitates a regional wastewater approach.
4. The WPCP is part of the Chico sanitary sewer system.
5. The City of Chico Municipal Code Section 15.40.285, “Regulation of Waste Received from Other Jurisdictions,” requires that any project with another municipality which would utilize the Chico sanitary sewer system requires an intermunicipal agreement (IMA) and sets out the requirements for such agreement.
6. To initially draft such an IMA, the Councils of the Town of Paradise, and City of Chico formed a Sewer Regionalization Project Advisory Committee (Committee) as a mechanism for exploring this proposal. The Committee was composed of two elected officials from each entity.
7. The Committee developed 17 Principles of Agreement (POA) that were posted for public review and comment between March 25 and April 25, 2022. No comments were received.
8. At a City Council meeting on June 7, 2022, and Town Council meeting on June 14, 2022, the two Councils approved the POA and directed counsel for each party to develop the IMA, based on the POA. A copy of the approved POA is attached and incorporated as Exhibit 1 to this Agreement.
9. On or about November 7, 2022, the Town Council certified the Program EIR for the Project; in addition, the Town filed a Notice of Determination for the Final Program EIR on December 8, 2022.
10. This IMA is intended to be a living and flexible document to guide the future relationship between the Parties in regarding the use of the Chico Sanitary Sewer System at the connection to the WPCP.

Section 1. Recitals.

The Recitals set out above are true and correct.

Section 2. Definitions.

Unless the context otherwise requires, the terms defined in this Section 2 shall for all purposes of this Agreement have the meanings specified here:

AUTHORIZED REPRESENTATIVE: The Town of Paradise Town Manager or designee and the City of Chico City Manager or designee.

CHICO SANITARY SEWER SYSTEM: The sewer system within the City of Chico, separate from the Town sewer system.

CHICO WPCP or WPCP: The Chico Water Pollution Control Plant.

CITY: The City of Chico.

COMBINED FLOW: The total flow within the pipe

CORE COLLECTION SYSTEM: The sewer system within the Town of Paradise identified in the Sewer Service Area.

DISCHARGE: The introduction of pollutants or wastewater into the City's sanitary sewer system by any means.

EXPORT PIPELINE SYSTEM: The portion of the Paradise Sewer Project beginning at the downstream point of the Town collection system and ending at the connection to the Chico WPCP.

INFILTRATION: Any inflow entering a collector, trunk, or interceptor sewer or service connections thereto from the ground through such means as, including but not limited to, defective pipes, pipe joints, connections, or manhole walls.

INFLOW: Any non-sewer discharge into the collector, trunk, or interceptor sewer or service connections thereto from such sources as, but not limited to, roof leaders, cellars, yard and area drains, foundation drains, cooling water discharges, drains from springs and swampy areas, manhole covers, cross-connections from storm sewers and combined sewers, catch basins, storm waters, surface runoff, street wash waters or drainage.

MAINTENANCE AND OPERATION COSTS: The reasonable and necessary costs of maintaining and operating a wastewater collection system calculated on sound accounting principles, including but not limited to the reasonable expenses of management, operation, repair and other expenses necessary to maintain and preserve the system in good repair and working order, and reasonable amounts for administration overhead, insurance, taxes (if any) and other similar costs.

MGD: Million gallons per day.

PRETREATMENT: The reduction of the amount of pollutants, the elimination of pollutants, or the alteration of the nature of pollutant properties in wastewater prior to or in lieu of discharging or otherwise introducing such pollutants into the Town or City's sanitary sewer system. The reduction or alteration can be obtained by physical, chemical or biological processes; by process changes; or by other means, except by diluting the concentration of the pollutant unless allowed by an applicable pretreatment standard.

PRETREATMENT PROGRAM: The City of Chico Municipal Code pretreatment requirements for wastewater pursuant to Chico Municipal Code Chapter 15 Article 3 commencing with Section 15.40.027.

PROJECT: The entire wastewater project that the Town of Paradise will construct to collect and convey wastewater to the Chico WPCP, also called the Paradise Sewer Project.

SANITARY SEWAGE: All liquid and water-carried waste from residences, business buildings, institutions, or other similar establishments, excluding storm waters, combined flow, and industrial waste.

SEWER SERVICE AREA: The area within the Town of Paradise where wastewater is collected consisting of the Core Collection Area (approximately 1,400 parcels within the Town's downtown and evacuations corridors). At no time shall the Sewer Service Area extend beyond the Town limits.

TOWN: The Town of Paradise.

TOWN CORE COLLECTION AREA/SYSTEM: The Wastewater Collection system within the Town of Paradise Sewer Service Area.

TOWN WASTEWATER FACILITIES: The combination of the Core Collection System and Export Pipeline System.

WASTEWATER: The liquid and water-carried industrial or domestic wastes from dwellings, commercial buildings, industrial facilities, and institutions, whether treated or untreated, which is contributed into or permitted to enter the Chico WPCP. This includes infiltration, inflow, and combined flow.

WASTEWATER COLLECTION: The combined sewer system, including pipelines conveying sewer.

WASTERWATER TREATMENT SERVICES: The services provided by the City of Chico to the Town of Paradise pursuant to this Agreement.

Section 3. General Terms and Conditions.

A. Purpose of Agreement:

It is intended that this Agreement meet the requirements of the applicable provisions of Chico Municipal Code Section 15.40.285 for an inter-municipal agreement for connection of the Town's Sewer Service Area to the Chico WPCP as well as provide for the roles and responsibilities for the provision of wastewater discharge for the Paradise Sewer Project.

It further is intended that this Agreement serve as an inter-municipal agreement to be submitted to the Butte County Local Agency Formation Commission.

B. Term and Termination:

This Agreement shall become effective as of the date of approval of both Parties and thereafter an Extension of Services approval by the Butte County Local Agency Formation Commission; thereafter, it shall continue in full force and effect until terminated by written agreement of all the parties hereto, as provided in Section 17, or by operation of law.

C. Scope of Authority and Services:

1. City's Financial Responsibility: The City shall finance, construct, reconstruct, operate, repair and maintain all facilities for the treatment and disposal of sanitary sewage and industrial waste delivered to the WPCP originating from the Town's Sewer Service Area in compliance with all applicable laws and regulations and the terms of this Agreement. Except as otherwise provided herein, the City shall not be financially responsible for any costs of Town's Wastewater Facilities.
2. Town's Financial Responsibility: Except as otherwise provided herein, the Town shall be financially responsible for any and all costs of Town's Wastewater Facilities and shall finance, construct, reconstruct, operate, repair and maintain all collector and trunk sewers for wastewater originating within its Sewer Service Area in compliance with this Agreement and all applicable laws and regulations, including but not limited to those of the City of Chico and specifically Chico Municipal Code Sections 15.40.024 and 15.40.027, and the terms of this Agreement.

D. Project Committee:

Upon execution of this Agreement by both Parties, each Party shall appoint an Authorized Representative to represent it in dealing with ongoing operations and provide written notice and contact information for its Authorized Representative to the other Party.

During the construction of the Project, the Parties shall work together through a project coordination team (PCT). The PCT will include each Party's Authorized Representative and such other staff or consultants as each Party desires. The PCT will meet periodically as agreed by its members, but at least monthly, to review progress and cooperate in fulfilling each Party's responsibilities under this Agreement.

Upon completion of the Project and connection to the WPCP, the Authorized Representatives shall continue to represent each Party and the PCT will continue to assist the Parties.

Each Party shall bear its own expenses for the PCT unless otherwise agreed in writing.

E. Good Faith Cooperation:

The Parties will act in good faith and cooperate with each other in operating the Paradise Sewer Project and the WPCP. The Parties will provide the necessary services of their Authorized

Representatives to perform their duties under this Agreement and provide any necessary institutional and financial support to meet their obligations under this Agreement.

F. Disclosure of Financial Information, Operating Data, and Other Information:

Each Party agrees to furnish such financial, operating, and other data pertaining to the Paradise Sewer Project and WPCP respectively as may be requested by the other Party or the State Water Resources Control Board.

G. Operating Agreement:

The City and Town will enter into a more detailed Operating Agreement which may become part of this Agreement. That Operating Agreement shall deal with the engineering and technical details of the connection to the WPCP and system operations and maintenance thereafter. The Operating Agreement also may allocate operational responsibilities and costs. The execution of the Operating Agreement is a condition precedent to the Town discharging any wastewater to the WPCP.

Section 4. City Provision of Wastewater Capacity to the Town.

- A. The City guarantees that in consideration of the Town's initial treatment connection payment (described in Section 12), commencing as of _____, the Town of Paradise is allocated, guaranteed and entitled to discharge up to, but no more than, 0.464 million gallons per day (mgd) average dry weather flow (ADWF) to the WPCP. ADWF will be calculated using criteria specified by the Central Valley Regional Water Quality Control Board in the Chico National Pollutant Discharge Elimination System (NPDES) permit as revised from time to time.
- B. If the Town exceeds this allocated amount of discharge, Town shall pay to City normal fees plus a flat 20% penalty fee.
- C. When the Town's discharge reaches 90% (0.4176 mgd) of the agreed upon 0.464 mgd capacity allocation, the following shall occur:
 - 1. Town will prepare and submit to the City an Allocation Assessment Report. The report shall include a review of options, including maintaining the 0.464 mgd flow limit, or commence efforts to negotiate additional capacity to be discharged to the WPCP, including required environmental review and approvals.
 - 2. The Town will review proposed or new connections and continue to approve new connections only in a manner that does not exceed the 0.464 mgd allocation.
 - 3. If the Town reaches the 0.464 mgd flow limit, the Town shall not allow additional connections to its sewer system until discharges are reduced to the flow limit. Alternatively, the City and Town, in an Amendment pursuant to Section 19.E Modifications of Agreement, may agree on an increase in the allowable discharge to the WPCP, including required environmental review and approvals.

- D. The boundaries of the area served under this Agreement cannot exceed the boundaries of the Town.
- E. All other applicable requirements for the connection of the Core Collection and Extended Collection Systems must be met, including but not limited to capacity at the Chico WPCP.
- F. The Town and the City shall prohibit connections to the Export Pipeline System from that portion of the pipeline that sits outside of the Town limits.

Section 5. Town Adoption of City Sewer Use Ordinance.

- A. The Town will adopt a sewer use ordinance at least as stringent as that set out in City Municipal Code Section 15.40 Article II (attached and incorporated as Exhibit "2") which ordinance is acceptable to the City. Town thereafter will update the ordinance so that it remains consistent with the City's ordinance (the "Sewer Use Ordinance"). Such ordinance shall be in effect no later than the time of the completion of construction of the Export Pipeline System and before connection to the WPCP.
- B. The Sewer Use Ordinance shall apply to all Wastewater discharges from the Town.
- C. The Sewer Use Ordinance shall address and the Town shall develop and administer a Sewer Application process. The Sewer Application process shall consist of two parts: a Town-reviewed portion for the connection to the Core Collection or Extended Collection System and a City-reviewed portion for treatment for industrial uses which meet the discharge thresholds set out in Section 15.40.285 (the Pretreatment Program, attached and incorporated as Exhibit "3").
- D. The Town generally will not be required to pretreat its discharges. However, all Town wastewater discharges are subject to the Pretreatment requirements of the City's Pretreatment Program as set out in this Agreement and in the City Code.
- E. The City review of Town wastewater discharges for Pretreatment requirements will be the same as the existing program within the City. When the proposed Discharge exceeds the thresholds established in the Pretreatment Program, the discharger will be required by the City to treat its Discharge to a sufficient degree to meet the City's Pretreatment Program requirements. The Town does not have a role in enforcing such requirements.

Section 6. Information Provided by the Town to the City:

A. Quarterly Report:

Commencing as of the first date of the discharge into the Export Pipeline System, the Town shall submit a quarterly report of all entities discharging into its Core Collection System, classified by residential and commercial dischargers. The report shall be in a format determined by the City. This quarterly report also shall contain an estimate of the number of new connections estimated to

occur over the next 12-month period, broken down by the same classifications, and expected changes in volume and character of wastewater discharge within that time period.

B. Annual Inventory:

The annual inventory shall be based upon the quarterly inventory and shall reflect data from July 1 through June 30 of each fiscal year, and will be submitted by August 1 of each year, commencing with the first year of operation of the Core Collection System.

The annual and quarterly reports and inventory process also shall apply to the Extended Collection System and any other connections within the Sewer Service Area.

The Town also shall provide information requested by the City Director of Public Works ("Director"), including but not limited to a description of the quality and volume of wastewater discharged to the City's sanitary sewer system by the Town and such other information as the Director shall deem necessary.

Section 7. Access to Town Facilities.

- A. The Town hereby grants to the City access to the Town Wastewater Facilities, including but not limited to those within the Town's boundaries for purposes of inspection, sampling, and other duties deemed necessary by the City. The City will give the Town sufficient notice to allow the Town to arrange safe access to the facilities. The Town and City will agree upon efficient ways to jointly conduct inspections to minimize impacts to both entities' staff.

Section 8. Wastewater Monitoring.

- A. As part of the Project, the Town will construct the Flow Control and Metering Structure which will contain flow control and monitoring equipment. The Flow Control and Metering Structure will be located at or near the WPCP. The Flow Control and Metering Structure shall contain Wastewater monitoring equipment (e.g., flow meter, composite sampler). Because the City has staff familiar with this type of equipment, and because it has its own Wastewater laboratory for testing Wastewater samples, the flow metering and monitoring equipment may be operated and maintained by City staff or their designees, and samples may be processed in the City lab or designated lab. The costs for these services shall be incorporated within the agreed-upon monthly fee structure for Wastewater Treatment Services provided by the City to the Town.
- B. Consideration will also be given by the Parties to having some level of monitoring equipment at the upper end of the Export Pipeline System with access granted by the Town to the City.

Section 9: Pretreatment: Administration and Compliance with Requirements.

- A. It is anticipated that a majority of the Wastewater discharges into the Paradise collection system will be of typical residential and commercial quality. However, all potential Town discharges will be subject to the Pretreatment requirements of this Agreement.

- B. The Town shall follow the City's Pretreatment Program, including future changes required by law or by the City. The Town will not develop a pretreatment program of its own. This includes but is not limited to the City's Fats, Oils & Grease (FOG) program. Dischargers will follow the City's Pretreatment Program application process, which includes setting monthly fees to be paid to the City. Pretreatment program fees will be collected by the Town and conveyed to the City, similar to the process outlined in Chapter 15 Article 3 commencing with 15.40.027 of the Chico Municipal Code.
- C. Application for sewer service first shall be made to the Town. Thereafter, all such applications will be provided to the City for review for Pretreatment requirements. The City has a Pretreatment Program to identify and monitor industrial or commercial dischargers who exceed certain thresholds. The review for Pretreatment requirements will be the same process as currently used by the City. If the proposed discharge exceeds the thresholds established in the Pretreatment Program, the discharger will have to treat its discharge to a sufficient degree to meet the City's Pretreatment Program requirements. The Town will reimburse the City for the costs of handling Pretreatment applications upon receipt of an invoice from the City showing the number of applications and per application cost.
- D. The Town shall provide the City with all information it obtains relative to meeting the City's Pretreatment Program requirements.

Section 10. Town Operation and Maintenance of Facilities.

- A. Subject to any exceptions and limitations set forth in this Agreement, the Town shall own and have the sole responsibility to finance, construct, reconstruct, operate, repair, replace and maintain all collector and trunk sewers for Wastewater originating within the Sewer Service Area, and all components of the Export Pipeline System that conveys Wastewater from the Sewer Service Area to the Chico WPCP, including but not limited to the Flow Control and Metering Structure at or near the Chico WPCP.
- B. Inflow and Infiltration: Town will complete such corrective measures to eliminate excessive inflow and infiltration as are reasonably demonstrated to be cost effective by studies conducted and funded by the Town
- C. Nothing in this Agreement prohibits the Town from contracting with the City to carry out the Town's responsibilities as to the Export Pipeline subject to one or more separate agreements.

Section 11. City Operation of WPCP.

- A. Subject to the exceptions and limitations set forth in this Agreement, City has the sole responsibility to finance, construct, reconstruct, operate, and maintain the WPCP in compliance with all applicable regulatory requirements, as those may be modified from time to time.

Section 12. Allocation of Costs, Establishment of Service Rates and Procedures for the Collection of Sewer Rates and Delinquent Charges.

A. Initial Treatment Connection Payment:

In consideration of the provision of the capacity in the WPCP set out in this Agreement, the Town shall pay to City approximately \$14.9 million, payable in full at the time initial Wastewater flows begin from the Core Collection Area. This amount may be recalculated approximately six months before that date pursuant to the "Regionalization Planning Report for the Paradise Sewer Project (March 2022)," attached and incorporated as Exhibit "4."

This payment shall be used by the City only for capital costs associated with projects implemented at the WPCP. No flows shall be accepted by City until this payment has been made. The Town at its sole discretion may provide for the recovery of all or a portion of this payment in its sewer rates or sewer connection and capacity charges.

B. Subsequent Treatment Connection Fees:

In the event a new project or modification by the City is required solely for the purpose of sustaining the Town's connection, the City shall formally notify the Town of anticipated improvements, costs and schedules for an evaluation of alternatives including the Town modifying its monthly sewer rates. The Town shall pay to the City the Town's proportionate share of costs for improvements or modifications to the WPCP required by any regulatory agency only as a result of the Town connection and excluding any such costs for City connections or services.

C. Town Capacity and Connection Charges:

The Town will develop both capacity and connection charges as well as sewer impact fees applicable to new connections to the sewer system in the amounts and in the manner allowed by law.

D. Town Monthly Sewer Rates:

The Town shall develop sewer rates to be billed on a monthly basis, which will include the Town's and City's costs. Such rates shall be in the amounts allowed by law and shall be approved as required by Proposition 218 and other applicable laws. The City's monthly costs associated with wastewater treatment and disposal at the WPCP shall be included in such rates along with any additional pretreatment fee charged to special dischargers, according to the same metric as the City ratepayers.

E. Town Collection of Sewer Rates:

The Town shall periodically levy, bill, and use reasonable efforts to collect from each of its residential and commercial system users such sewer user charge.

F. Town Sewer Rate and Payment Records:

Adequate records shall be maintained by the Town to permit ready, separate identification of City Services and of local service charges, amounts received, and payments made to the City.

G. Pretreatment Costs:

In addition to City Wastewater treatment and disposal charges, a Town discharger subject to pretreatment requirements shall be responsible for payment of the City's charges for participating in the Pretreatment Program. Pursuant to Section 6, City shall collect all information from the Town needed to compute such charges and administer the approval process, provide such costs to the Town for such charges and adjust such charges as allowed by law. The Town shall be responsible for including such cost in its monthly sewer billings. The City shall be responsible for compliance with applicable law in setting such charges.

Section 13. Town Payment of Sewer Charges to City.

- A. Not later than 45 calendar days following the date of each regular periodic billing for sewer charges, the Town shall pay to the City a sum that equals the total of all charges for City that were charged to Town for that billing period, regardless of the amount collected by Town from its users. Payments shall be accompanied by a summary identification by billing categories. A periodic (semi-annually) report shall be submitted to the City reconciling billings with payments.

Section 14. Monthly Treatment User Fees.

- A. In addition to any other user and Pretreatment fees, the City shall establish a WPCP treatment fee as part of its overall City fee structure. Similarly, the Town of Paradise users will be charged WPCP treatment fees in accordance with residential, commercial, and industrial uses, and such fees shall not be higher than the proportional fees collected from the City's rate payers for WPCP treatment.

The Town will pay the treatment fee established in the City's fee schedule, including any future increases made to those fees. For any fee increases to City users, the City shall undertake the Prop 218 process. For any fee increases to Town users, whether initiated by Town or passed through to Town by City, Town shall undertake the Prop 218 process as required by law.

The Town will collect the treatment monthly user fee from its users. The Town will submit the total treatment monthly user fee amount to the City as set out in Section 13 above.

Section 15. Additional Provisions.

A. No Joint and Several Liability:

Neither party to this Agreement nor any officer or employee thereof shall be responsible for any liability occurring by reason of anything done or omitted to be done by the other party to this Agreement under or in connection with any work, authority or jurisdiction delegated to said other party under this Agreement. It is understood and agreed that this Agreement does not create a joint powers agency and, pursuant to California Government Code Section 895.4, each party to this Agreement shall fully indemnify and hold each other party to this Agreement harmless from any liability imposed for injury (as defined by California Government Code Section 810.8) occurring by reason of anything done or omitted to be done by said indemnifying party under or in connection with any work, authority or jurisdiction delegated to said party under this Agreement. There shall be no joint and several liability as a result of this Agreement.

B. Auditing Records:

The City and Town shall have the authority to appoint such auditors as it deems necessary for the examination of financial records of the Town and City to determine compliance with this Agreement. The Town and City shall make available to such auditors all requested records and will assist and cooperate with the auditors in their efforts. Examples of required documentation from the Town may include reasonable efforts to collect delinquent charges; details of uncollectable charges; and account billing information by parcel. Examples of required documentation for the City may include receipts of Town payments.

Section 16. Resolution of Disputes.

- A. "Dispute" means disputes, claims or other matters in question regarding the discharge of wastewater from the Town Wastewater Facilities to the Chico WPCP, which may or may not be a breach of this Agreement. Either party may initiate the dispute resolution process. No matter will be considered if it is a claim barred by an applicable statute of limitations or the provisions of local, state or federal law.

1. Initial Informal Resolution:

Either Party's Authorized Representative may provide the other Party's Authorized Representative a written letter or memo setting out the dispute in writing in sufficient detail to allow its resolution (with relevant back up materials), the remedy sought and the timing for resolution. The receiving party may request additional information. Once each side has the information necessary, the Authorized Representatives shall meet (in person or virtually) within a reasonable period of time (not to exceed one month) to try to resolve the dispute. Any resolution shall be in writing, attached to all materials provided, and retained for future reference.

2. If the Authorized Representatives cannot resolve the dispute, the process will be repeated with the senior executives of each party (i.e., public works director or city manager).
3. If the matter involves a technical operational matter, and the Parties themselves cannot resolve it, they may designate an independent expert to analyze the issue and provide recommendations for resolution. The Parties will evenly divide the costs of such an independent expert.
4. If the dispute is not otherwise resolved, the Parties will engage in non-binding mediation or arbitration.
5. Mediation:

If the Dispute is not resolved, then prior to any litigation of the Dispute commenced by either or both Parties, the Parties must jointly attempt to resolve the Dispute through mediation with a mutually acceptable mediator. If the Parties are unable to agree on a mediator within ten days of the request for mediation, then the Party requesting the mediation will request that JAMS or the American Arbitration Association to appoint a mediator from its personnel/panel experienced in similar disputes.

With the prior written approval of the Parties, the mediator may engage an expert consultant to provide independent analysis to the mediator on technical matters, which analysis the mediator may share with the Parties in mediator's discretion. The Parties and mediator will schedule a mediation session at a mutually acceptable time. Representatives from each Party who have authority to resolve the Dispute will attend the mediation. The mediator will have no authority to make binding decisions; any resolution of the Dispute during mediation requires the written agreement of both Parties. The Parties will bear the cost of mediation equally.

If mediation is not successful, the Parties may pursue any other remedy allowed by law and not prohibited by this Agreement, including but not limited to, binding arbitration or court action.

6. Continuation of Work:

Each Party must continue to perform its obligations under this Agreement, including but not limited to making all undisputed payments, regardless of the existence of a Dispute or the pendency of dispute resolution proceedings between the Parties. In no case shall the treatment of wastewater delivered from Paradise to the Chico WPCP cease.

Section 17. Default.

A. Failure of Chico to Properly Treat Wastewater:

It is understood and agreed that City, in granting to the Town the rights herein specified to discharge Wastewater into the WPCP and to have such Wastewater treated and disposed of in said system, is agreeing that the WPCP will be able to satisfactorily treat such Wastewater when delivered pursuant to the terms of this Agreement. In the event the Chico WPCP should for any reason be incapable of satisfactorily conveying, treating, or disposing of Wastewater discharged from the Town, the Town shall in no way be liable to the City for any damages arising or resulting from or suffered because of that failure; provided, however, that the Town shall not knowingly permit to be discharged into Chico WPCP any Wastewater from any source at rates of flow, strength or other characteristics inconsistent with this Agreement or those for which the WPCP is designed to handle or has been shown capable of handling by prior experience. The Parties agree that the City's obligations are unique and that the City's failure to meet its obligations under this Agreement would result in Town being unable to supply wastewater treatment in compliance with regulatory requirements, or in providing continuing sewer services, thereby harming the public welfare.

Therefore, without limiting any other of the Town's rights or remedies if the City fails to cure a material default which results in Town being unable to use the WPCP facilities, City agrees that the Town may bring an action for specific performance of this Agreement by the City, without waiving (1) any defense to such action; (2) its right to contest whether the City is in breach of a contractual obligation or (3) Town's obligation under Civil Code Section 3386 (or any successor statutory provision) to assure Town's performance of this Agreement.

B. Failure of Paradise to Properly Convey Wastewater:

Except as provided in Section 17.C, below, City agrees that its only remedy for a material default by the Town is a claim for monetary damages to the extent allowed under this Agreement. Except as provided in Section 17.C, below, in no event may the City suspend, slow down or cease to fulfill its obligations under this Agreement to operate the Chico WPCP and accept Paradise wastewater without the written consent of the Town. Except as specifically provided otherwise in this Agreement, before the City may seek a remedy for a material default by the Town, the City must provide written notice of such default to the Town. The notice must describe the nature of the default and identify a reasonable period for cure which must be at least 30 thirty calendar days after the notice of default and which will be extended as reasonably necessary for the cure of that default, so long as the Town commences and pursues the cure with reasonable diligence during the identified time period. If the Town fails to cure the default within that time period, then the City may proceed with dispute resolution set out in Section 16.

C. Termination:

Parties agree to fully exhaust all measures outlined in Section 16 of this Agreement prior to consideration of termination of this Agreement. Parties further agree that if termination of this Agreement needs to be explored, terms shall be incorporated within a formal Amendment to this Agreement pursuant to Section 19.E Modifications of Agreement.

Section 18. Insurance and Indemnification.

A. Insurance:

Insurance requirements for both the City and Town are listed in Exhibit "5" of this Agreement.

B. Town's Duty of Indemnification and Defense:

To the fullest extent permitted by law, Town will defend, indemnify and hold City and its officers, agents and employees harmless from any and all claims, losses, damages, liabilities, fines, penalties, administrative proceedings, legal actions and expenses (including reasonable legal, expert witness and consulting fees and costs) to the extent arising out of, or resulting from the active negligence or willful misconduct of Town in connection with the Paradise Sewer Project or arising out of this Agreement.

If Town fails diligently to defend any such claim or proceeding, City shall have the right, but not the obligation, to do so at the Town's expense. The duty to defend will apply, and Town will be required to furnish a defense, notwithstanding that there has not yet been an adjudication or finding of liability on the part of either Party, or as to whether an exception to provide a defense or indemnity may apply.

Notwithstanding the above, Town will not be required to defend, indemnify and hold harmless City or its officers, employees or agents ("City") when such claims, losses, damages, liabilities and expenses arise from the sole active negligence or willful misconduct of City or those for whom City is responsible, which include fines imposed by administrative agencies, specifically including but not limited to fines from the Regional Water Board arising from City's operation of the WCPC.

C. City's Duty of Indemnification and Defense:

To the fullest extent permitted by law, City will defend, indemnify and hold Town and its officers, employees and agents affiliates harmless from any and all claims, losses, damages, liabilities, fines, penalties, administrative proceedings, legal actions, and expenses (including reasonable legal, expert witness and consulting fees and costs) including but not limited to those for costs for fines imposed by the Regional Water Board or other agencies arising from City's operation of the WCPC, to the extent arising out of or resulting from the active negligence or willful misconduct of City in providing or failing to provide services at the WPCP under this Agreement, and including but not limited to any challenges arising under City's rate setting process. Notwithstanding, the City will not be required to defend, indemnify, and hold harmless Town or its officers, employees or agents for their sole active negligence, or willful misconduct.

The City's obligations include providing the Town with copies of pleadings or other documents and the status of all such proceedings; coordinate any settlement of such claims and obtain full releases.

If City fails diligently to defend any such claim or proceeding, Town shall have the right, but not the obligation, to do so at the City's expense. The duty to defend will apply, and City will be required to furnish a defense, notwithstanding that there has not yet been an adjudication or finding of liability

on the part of either Party, or as to whether an exception to provide a defense or indemnity may apply.

Section 19. Miscellaneous.

A. Force Majeure/State of Emergency:

Force Majeure Event means a natural disaster, terrorist action or act of war, epidemic, pandemic, grave natural disaster, negligence on the part of the state, the United States, or any department or agency thereof, an act of governmental agency an intentional ace of a third party, the effects of which could not have been prevented or avoided by the exercise of due care or foresight, any other circumstance or event that causes a discharge despite the exercise of every reasonable precaution to prevent or mitigate the discharge or other emergencies, whether or not declared a State of Emergency beyond the control of the Parties that that impacts performance under this Agreement.

1. In anticipation of or upon occurrence of any Force Majeure Event, each Party will notify the other's Authorized Representative. The Parties will notify and follow the guidance of the State Water Resources Control Board and Central Valley Water Resources Control Board.
2. During the period of any Force Majeure Event the performance of this Agreement is abated and/or excused to the extent such performance was rendered impossible or extremely difficult.
3. If a Force Majeure Event caused damage to the Chico Sanitary Sewer System, City shall use reasonable efforts to restore or mitigate the damage. City shall perform such restoration or mitigation in a reasonable time under the circumstances and at the sole cost and expense of City.
4. If a Force Majeure Event caused damage to the Town Wastewater Facilities, Town shall use reasonable efforts to restore or mitigate the damage. Town shall perform such restoration or mitigation in a reasonable time under the circumstances and at the sole cost and expense of Town.

B. Emergency Notification:

Each Party will promptly notify the other of material problems in the operation of the Paradise Sewer Project or Chico WPCP that affect the other Party, including, but not limited to:

1. Contamination from Paradise into the Export Pipeline.
2. Break in the Export Pipeline.
3. Reduced capacity at the WPCP.
4. Discharge violations at the WPCP.

C. Notice:

Notices required or permitted under this Agreement shall be sufficiently given to a party if in writing and if either served by email, facsimile, personally upon or mailed by registered or certified mail to the clerk of its governing body.

D. Time of the Essence:

Time is of the essence in this Agreement.

E. Modification of Agreement:

No term, provision, or condition of this Agreement shall be altered, amended, or departed from or be held or construed to have been waived except by the unanimous agreement and consent of the parties to this Agreement as evidenced by resolutions adopted by their respective governing bodies specifically authorizing the amendment. No waiver of any term or condition of this Agreement shall be a continuing waiver thereof.

This Agreement shall be reviewed 3 years from initial execution and every 5 years thereafter by the Parties and updated or revised as necessary.

Any modifications to the Agreement shall include a formal notification to the Water Board prior to execution.

F. Severability:

If any paragraph, subparagraph, sentence, clause, phrase, or word of this Agreement, or the application thereof, to any party, or to any other person or circumstance is for any reason held invalid, it shall be deemed severable and the validity of the remainder of the Agreement or the application of such provision to the other parties, or to any other persons or circumstance, shall not be affected thereby. Each party hereby declares that it would have entered into this Agreement and each paragraph, subparagraph, sentence, clause, phrase, and word thereof irrespective of the fact that one or more paragraphs, subparagraphs, sentences, clauses, phrases, or words, or the application thereof to any party or any other person or circumstance, be held invalid.

G. Further Assurances:

Each Party will adopt, make, execute and deliver any and all such further resolutions, instruments and assurances as may be reasonably necessary or proper to carry out the purposes and intent of this Agreement.

H. Jurisdiction and Venue:

This Agreement will be governed by the laws of the State of California. The Parties agree that the exclusive venue for any legal proceeding brought under this Agreement will be in the County of Butte, State of California.

I. Successors and Assigns:

It is mutually agreed by all the parties hereto that the agreements, covenants, conditions, limitations, restrictions, and undertakings herein contained shall apply to and bind the successors and assigns of the respective parties hereto as if they were in all cases named.

CITY OF CHICO



Mark Sorensen, City Manager

Date: 03-08-2023

Approved as to form:

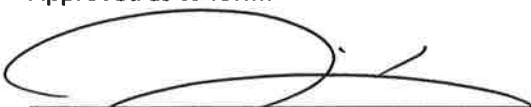

Vincent C. Ewing, City Attorney

Date: 3-8-23

ATTEST:



Deborah Presson, City Clerk

Date: 3-8-23

TOWN OF PARADISE



Kevin Phillips, Town Manager

Date: 3-3-23

Approved as to form:



Scott Huber, Town Attorney

Date: March 2, 2023

ATTEST:



Dina Volenski, Town Clerk

Date: March 3, 2023

Final Principles of Agreement (version 7, 21-March-2022)

Introduction and Background

Through its work on the Paradise Sewer Project (Project), the Town of Paradise (Town) has identified a connection to the Chico Water Pollution Control Plant (WPCP) as its preferred alternative for wastewater treatment and disposal, and has approached the City of Chico (City) to explore the feasibility of such a connection. The Councils of the Town of Paradise and City of Chico have formed a Sewer Regionalization Project Advisory Committee (Committee) as a mechanism for exploring this proposal. The Central Valley Regional Water Quality Control Board (Regional Board) has agreed to facilitate the activities of the Committee.

Membership on the Committee is limited to elected officials from the Town and City, as those two parties are signatories to the Cooperative Funding Agreement (CFA) and will be signatories to a future inter-municipal agreement (IMA). The Town and City have both designated their Mayors and Vice Mayors as their Committee members.

The Committee will develop an agreed-upon list of basic principles for an IMA, which will be captured in this document, the Principles of Agreement (POA). It is anticipated that a draft POA will be developed by the Committee, which will then be brought to the Town Council and City Council for review and approval. The final POA would then be turned over to legal counsel from the Town and City to draft into an IMA for consideration by the Town Council and City Council.

City of Chico Municipal Code

The City of Chico has a provision in its municipal code *Section 15.40.285—Regulation of Waste Received from Other Jurisdictions* that specifically addresses handling wastewater from outside the city's sanitary sewer system. That code section is presented in its entirety at the end of this document.

Principles of Agreement

The Principles of Agreement are divided into 17 subject areas, as listed below. (Other subject areas may be added over time.) The first eight items reflect the eight items specified in Section 15.40.285. Over the course of its work, the Committee will develop specific agreed-upon statements (principles of agreement) for each of these items.

1. **Sewer Use Ordinance:** The Town will need to adopt a sewer use ordinance that parallels the City's sewer use ordinance. The POA could contain a commitment from the Town to have an ordinance completed by a certain milestone.
 - **AGREED:** The Town will adopt a sewer use ordinance that parallels the City's ordinance. The Town's ordinance shall be adopted and in place 30 days prior to the commencement of discharge into the Project.
2. **User Inventory:** The Town will need to submit an annual inventory of entities discharging into the sewer system. The POA could contain a statement to that effect.
 - **AGREED:** The Town will submit a quarterly inventory of entities discharging into its sewer system, classified by residential and commercial dischargers. This quarterly report will also contain an estimate of new connections estimated to occur over the upcoming 12 months, broken down by the same classifications.

This inventory will reflect data from July 1 through June 30 of each year, and will be submitted by August 1 of each year.

- **AGREED:** The Town will develop and administer a Sewer Application process, with two parts—a Town-reviewed portion for the collection system and a City-reviewed portion for treatment. The treatment portion will follow the existing City sewer application. If the proposed discharge exceeds the thresholds established in the pretreatment program (see below), it will have to treat its discharge to a sufficient degree to meet the City's pretreatment program requirements. Businesses would face the same pretreatment requirements, whether they are in Paradise or Chico.
 - **AGREED:** The Town and the City agree to prohibit future connections to the export pipeline in the portion of the pipeline that sits outside of the Town limits or City limits.
3. **Pretreatment:** The City has an existing pretreatment program to monitor industrial/commercial dischargers, which Town dischargers will need to meet. (The City has two employees conducting annual inspections of commercial/industrial dischargers.) The POA could contain a statement to that effect. In addition, the Town will need to decide whether to create and administer its own pretreatment program, or simply comply with the City's pretreatment program. Ultimately, the Town and City will need to determine who implements the various pretreatment activities for Paradise dischargers. The POA could contain the basic definition of these divisions of responsibility.
- **AGREED:** The Town will follow the City's pretreatment program, including future changes; the Town will not develop a pretreatment program of its own. This includes the City's Fats, Oils & Grease (FOG) program. Dischargers would follow the City's pretreatment program application process, which includes setting monthly fees. Pretreatment program fees will be collected by the Town and conveyed to the City, similar to the process outlined in Item 10.
4. **Pretreatment Data Access:** The Town will need to provide the City with all information it obtains related to the pretreatment activities. The POA could contain a statement to that effect.
- **AGREED:** The Town will provide the City with all information it obtains relative to meeting the City's pretreatment program requirements.
 - **AGREED:** ~~Paradise will contract with the City or hire and use qualified professionals (Industrial Waste Inspectors, testing, labs, etc.) to conduct its pretreatment activities. [Staff Input: This statement may no longer apply, given the decision made on Item 3—Pretreatment. Delete.]~~
5. **Wastewater Limits:** The agreement will need to define limits on the volume and quality of Paradise wastewater discharged to the Chico Water Pollution Control Plant (WPCP). This will likely be addressed by the City's CFA efforts; the Committee would then review those

results and draft POA language. Town and City staff are currently awaiting results from the City's engineering consultant in order to draft suggested language for this item.

- **AGREED:** Associated with the treatment connection payment (described below), the Town of Paradise wastewater flow to the Chico WPCP will be limited to 0.464 million gallons per day (mgd) average dry weather flow (ADWF). ADWF will be calculated using criteria specified by the Central Valley Regional Water Quality Control Board in the Chico permit. It is anticipated that a majority of the wastewater discharges into the Paradise collection system will be of typical residential and commercial quality. However, all potential Town discharges will be subject to the Pretreatment requirements of this agreement, as specified in Section 3.
6. **Wastewater Monitoring:** The agreement will need to define how the volume and quality of Paradise wastewater will be monitored.
- **AGREED:** The Termination Structure, to be constructed as part of the Paradise Sewer Project, will contain wastewater monitoring equipment (e.g., flow meter, composite sampler). Because the City has staff familiar with this type of equipment, and because it has its own wastewater laboratory for testing wastewater samples, the flow metering and monitoring equipment will be operated and maintained by City staff, and samples will be processed in the City lab. Consideration will also be given to having some level of monitoring equipment at the upper end of the export pipeline. A payment will be negotiated at the start of the contract and paid annually by the Town to the City to cover the costs associated with these efforts.
7. **Access to Facilities:** The City will need to be granted access to the Town's wastewater facilities, including those within the Town's boundaries. The POA could contain a statement to that effect.
- **AGREED:** The Town will grant the City access to the Town's wastewater facilities, including those within the Town's boundaries for purposes of inspection, sampling, and other duties deemed necessary by the City. The City will give the Town sufficient notice to allow the Town to arrange safe access to the facilities. The Town and City will look for efficient ways to jointly conduct inspections to minimize impacts to both entities' staff.
8. **Remedies for Breach of Agreement:** Like all legal agreements, the IMA will need to address how the parties would handle any breach of the agreement. This item might need input from Town and City attorneys, in order to draft appropriate POA language. These remedies will vary by the various required items in this POA.
- **AGREED:** If disagreements exist between the Town and City attorneys regarding agreement language, those disagreements will be brought back to the Committee to attempt to resolve.

9. **Treatment Connection Payment.** A number of items need to be addressed related to the treatment connection payment to be paid by the Town for connecting to the Chico WPCP. These will likely be addressed by the City's CFA efforts; the Committee would then review those results and draft POA language. Items include:
- How much should the initial connection payment be (e.g., for the initial Paradise flow or the ultimate flow)?
 - If ongoing connection fees are to be collected for future connections, how much should they be (e.g., linked to the City of Chico's current connection fee schedule)?
 - How should they be collected and paid to the City of Chico (e.g., collected by the Town of Paradise on an ongoing basis and paid to the City of Chico quarterly)?
 - **AGREED:** The goal is to obtain funding for the treatment connection payment in a similar manner to the remainder of the Paradise Sewer Project. The payment is currently estimated at \$14.9 million (estimated as December 2026 dollars; as documented in "Regionalization Planning Report for the Paradise Sewer Project," Carollo Engineers, March 2022), which the Town of Paradise would pay to the City of Chico to cover treatment capital costs associated with a wastewater flow from the Town of 0.464 mgd ADWF (see ADWF definition above). From six to 12 months before the date of connection, the estimated treatment connection payment will be recalculated using the methodology established in the Carollo study. This payment is assumed to be made at the time that initial Paradise flows are sent to the Chico WPCP, currently estimated to start on or about December 2026.
10. **Monthly User Fees.** A number of items need to be addressed related to the monthly fees to be paid by the Town for discharging to the Chico WPCP. (Note: The City does not currently break its monthly fees into treatment and collection system components.) Items include:
- How much should the monthly user fees charged to the Town be (e.g., linked to the treatment portion of the City of Chico's current monthly user fees)?
 - **AGREED:** Assuming that the City establishes a treatment portion of its monthly user fee, the Town users will pay that treatment monthly user fee to the City. Town users will also pay a collection system monthly user fee to the Town associated with the Town's collection system and export pipeline O&M costs.
 - How should they be collected and paid to the City of Chico?
 - **AGREED:** The Town will collect the treatment monthly user fee from its users. The Town will submit the total treatment monthly user fee amount to the City on a [monthly/quarterly] basis. The Town will be responsible for collecting unpaid treatment monthly user fees from its users.

- How should future rate updates be handled?
 - **AGREED:** As discussed above, the Town users will pay the treatment monthly user fee established in the City’s fee schedule, including any future increases made to those fees. The assumption is that the City and Town users will pay the same monthly treatment fee based on the established fee schedule. Future increases will follow the Prop 218 process, including public noticing.
- [There is potential for power generation as the wastewater moves from Paradise down off the Ridge to Chico. Need to address potential for sharing any electrical generation revenue.]
 - **AGREED:** It is generally not practical to generate electricity from raw wastewater flows, especially intermittent flows that we will see in the export pipeline. Therefore, this item will not be addressed in the POA. [leave this item in the POA, to allow others to see the discussion/conclusion]
- [There is potential for Chico to treat its wastewater for recycling. Need to address the potential for revenue sharing.]
 - **AGREED:** Because the City’s wastewater system operates as an “enterprise” fund, any income or cost resulting from water recycling will be incorporated into the City’s connection fees and monthly user fees. This item can be stated in the POA as an item not included. [leave this item in the POA, to allow others to see the discussion/conclusion]
- [Include a requirement for producing an annual financial report.]
 - **AGREED:** In general, wastewater costs and revenues will be captured in the annual budgets of both the Town and City. Also, the City will be provided the ability to audit the Town’s financial records related to the collection of monthly treatment fees. Therefore, no separate annual financial report is needed.

11. **O&M of Facilities.** The Town will construct the export pipeline and a termination structure at or near the Chico WPCP. The Town would own the export pipeline. The POA would need to address who is responsible for O&M and future repairs/replacements of the export pipeline and termination structure at the Chico WPCP.

- **AGREED:** It is anticipated that the Town will own the entire export pipeline and will provide all operation and maintenance associated with it, with the exception of wastewater monitoring efforts, which are described in item 6 above.
- [It may work best to develop a separate “O&M Agreement” to cover all of the various items related to operating costs.]

- **AGREED:** The City and Town intend to develop an inter-municipal agreement based on these Principals of Agreement. In the future, if O&M items arise and warrant it, the two parties may wish to develop an O&M Agreement. For example, one item that might arise is that the Town might wish to contract with the City to provide some O&M services on the export pipeline, given that the City has on-staff expertise in this area.

12. **Term and Termination of the Agreement.** [Need to develop the term and termination of the agreement. The term of the agreement should match any financing requirements and/or the lifespan of the infrastructure. Also need to address how to handle disaster scenarios. This item might need input from Town and City attorneys, in order to draft appropriate POA language.]

13. **“Revisit” Clause.** [Need to develop a statement that allows for an evolution of the roles and responsibilities established in this document. For example, in the future, if the Town grows to a size that it makes sense for it to create and run its own pretreatment program, the document should allow for that to happen. This item will need input from Town and City attorneys.]

[ADDITIONAL ITEMS 14, 15, and 16 came from “Crafting Interlocal Water and Wastewater Agreements,” UNC Environmental Finance Center, 2019. Text in quotes is taken from that document]

14. **Service Area Boundary.** “When two or more service providers agree to buy or sell water services to one another, it is extremely important to remove as much ambiguity as possible about current and future service areas.” Identify the service area boundary as the Town of Paradise town limits. The Sphere of Influence and Town/City limits may change...

- **AGREED:** This item relates to the potential for the two entities to have adjacent or overlapping service area boundaries. The Town of Paradise and the City of Chico will not overlap with respect to providing wastewater services. In the future, spheres of influence could overlap (although this is extremely unlikely). If that situation arises, it should be addressed at that time. [Ask the attorneys for their input, including if language should be included on this subject in the inter-municipal agreement.]

15. **Notice Requirements for Fee Changes.** “The contract should also include language to cover notice requirements or any other processes related to when and how rates will be changed. If there will be a process for modifying rates in the future, the parties should contemplate what shall constitute reasons to justify modification.”

- **AGREED:** In California, formal notification to citizens regarding fee increases is covered by Prop 218. If the City is considering a fee update, City staff will inform the Town Council of an upcoming fee adjustment process.

16. **Excessive Inflow and Infiltration.** “Inflow and infiltration (I&I) can be a big problem for wastewater interlocal agreements. If possible, partners should consider how to contract in language that will address how I&I should be handled.”

- **AGREED:** Because the Town’s collection system and export pipeline will be entirely new, the initial amount of I&I should be very low. Over time, it is possible I&I will increase. The Town of Paradise will monitor its wet weather flows each year and assess the level of I&I it is experiencing. If excessive I&I is seen, the Town will complete such corrective measures to eliminate excessive I&I as are reasonably demonstrated to be cost effective by studies conducted and funded by the Town. [Perhaps move this item up to Section 11--O&M of Facilities]

17. **Resolving Conflicts or Disagreements.** [“Regardless of how carefully an interlocal agreement may be contracted, there can still be conflict or disagreement, particularly when unanticipated needs or challenges arise. Parties to an agreement should anticipate the need to potentially negotiate at some point during the life of the agreement, and should build in language that lays out what process should be used.” This item will need input from Town and City attorneys.]

- [Note from Staff: The City of Folsom/SRCSD contract has extensive sample language for this item, which the attorneys can use if they wish to.]

City of Chico, Code Section 15.40.285

The City of Chico has a provision in its municipal code, Section 15.40.285—Regulation of Waste Received from Other Jurisdictions, that specifically addresses handling wastewater from outside the city's sanitary sewer system. Here is the code section in its entirety:

15.40.285 Regulation of Waste Received from Other Jurisdictions

If another municipality or user located within another municipality contributes wastewater to the city's sanitary sewer system, the director shall enter into an inter-municipal agreement with the contributing municipality. Prior to entering into an agreement, the director shall request the following information from the contributing municipality:

- 1. A description of the quality and volume of wastewater discharged to the city's sanitary sewer system by the contributing municipality;*
- 2. An inventory of all users located within the contributing municipality that are discharging to the city's sanitary sewer system; and*
- 3. Such other information as the director may deem necessary.*

An inter-municipal agreement shall contain the following conditions:

- 1. A requirement for the contributing municipality to adopt a sewer use ordinance which is at least as stringent as this ordinance and local limits, including required baseline monitoring reports which are at least as stringent as those set out in section 15.40.024. The requirement shall specify that such ordinance and limits must be revised as necessary to reflect changes made to the city's ordinance or local limits;*
- 2. A requirement for the contributing municipality to submit a revised user inventory on at least an annual basis;*
- 3. A provision specifying which pretreatment implementation activities, including wastewater discharge permit issuance, inspection and sampling, enforcement, will be conducted by the contributing municipality; which of these activities will be conducted by the director; and which of these activities will be conducted jointly by the contributing municipality and the director;*
- 4. A requirement for the contributing municipality to provide the director with access to all information that the contributing municipality obtains as part of its pretreatment activities;*
- 5. Limits on the nature, quality, and volume of the contributing municipality's wastewater at the point where it discharges to the city's sanitary sewer system;*
- 6. Requirements for monitoring the contributing municipality's discharge;*
- 7. A provision ensuring the director access to the facilities of the users located within the contributing municipality's jurisdictional boundaries for the purpose of inspection, sampling, and other duties deemed necessary by the director; and*
- 8. A provision specifying the remedies available for breach of the terms of the inter-municipal agreement.*

ARTICLE II. DISCHARGE RESTRICTIONS

15.40.020 General prohibitions.

No user shall introduce or cause to be introduced into the city's sanitary sewer system any pollutant or wastewater which causes pass through or interference. These general prohibitions apply to all users of the city's sanitary sewer system whether or not they are subject to categorical pretreatment standards or any other federal, state, or local pretreatment standards or requirements.

(Ord. 2481 §1 (part))

15.40.021 Specific prohibitions.

No user shall introduce or cause to be introduced into the city's sanitary sewer system any of the following pollutants, substances, or wastewater:

1. Pollutants which create a fire or explosive hazard in the city's sanitary sewer system with a closed cup flashpoint of less than 140° degrees Fahrenheit (60 degrees centigrade) using the test methods specified in 40 CFR Part 261.21. Prohibited materials include, but are not limited to, gasoline, kerosene, naphtha, benzene, toluene, xylene, ethers, alcohols, ketones, aldehydes, peroxides, chlorates, perchlorates, bromates, carbides, hydrides, or sulfides. Closed cup flashpoint values may be found in the National Institute of Occupational Safety and Health (NIOSH) *Pocket Guide to Chemical Hazards*;
2. Wastewater having a pH lower than 5.0 or more than 11.5, or otherwise capable of causing damage or hazard to the city's sanitary sewer system;
3. Solids or viscous substances, including, but not limited to, fats, oils, or grease, garbage with particles greater than one-half inch in any dimension, animal guts or tissues, paunch manure, bones, hair, hides or fleshings, entrails, whole blood, feathers, ashes, cinders, sand, spent lime, stone or marble dust, metal, glass, straw, shavings, grass clippings, rags, spent grains, spent hops, wastepaper, wood, plastics, gas, tar, asphalt residues, residues from refining or processing of fuel or lubricating oil, mud, or glass grinding or polishing wastes, which may cause obstruction of flow in the sewer or other inference with the operation of the city's sanitary sewer system;
4. Pollutants including oxygen demanding pollutants (BOD, COD, etc.) released in a discharge at a flow rate and/or pollutant concentration which, either singly or by interaction with other pollutants, will cause interference to the city's sanitary sewer system;
5. Wastewater having a temperature greater than 140 degrees Fahrenheit (60 degrees centigrade), or which will inhibit biological activity in the water pollution control plant resulting in interference, but, in no case, wastewater which causes the temperature, at the introduction into the water pollution control plant which to exceeds 140 degrees Fahrenheit (60 degrees centigrade);
6. Petroleum oil, nonbiodegradable cutting oil, or products of mineral oil origin that will cause interference or pass through;
7. Pollutants which result in the presence of toxic gases, vapors or fumes within the city's sanitary sewer system in a quantity that may cause acute worker health and safety issues;
8. Trucked or hauled wastes, except at discharge points designated by the director;
9. Noxious or malodorous liquids, gases, or solids, which either singly or by interaction with other wastes, are sufficient to create a public nuisance or hazard to life, or are sufficient to prevent entry into the city's sanitary sewer system for maintenance and repair;
10. Wastewater that may cause a detrimental environmental impact or nuisance in the waters of the state or United States that is unacceptable to any public agency having regulatory jurisdiction over the city;
11. Wastewater which imparts color which cannot removed in the treatment process, such as, but not limited to, dye wastes and vegetable tanning solutions;
12. Wastewater causing two readings on an explosion hazard meter at the point of discharge into the city's sanitary sewer system (or at any point in the city's sanitary sewer system) of more than five (5) percent nor any single reading over ten (10) percent of the lower explosive limit (LEL) of the meter. Prohibited materials include, but are not limited to, gasoline, kerosene, naphtha, benzene, toluene, xylene, ethers, alcohols, ketones, aldehydes, peroxides, chlorates, perchlorates, bromates, carbides, hydrides, sulfides, and any other substances in any quantity or concentration that the city, state, or USEPA has notified the user are a fire hazard or a hazard to the city's sanitary sewer system;
13. Wastewater containing algacides, fungicides, antibiotics, insecticides, strong oxidizing agents or strong reducing agents in such quantity or strength as to cause or contribute to violations of the city's NPDES permit discharge restrictions, interference with or upset of the city's sanitary sewer system, or personnel safety hazards;
14. Medical waste, except as specifically authorized by the director, in a wastewater discharge permit;
15. Wastewater requiring an excessive quantity of chlorine or other chemical compound used for disinfection purposes;

16. Wastewater containing radioactive wastes or isotopes of such half-life or concentration as may exceed limits established by the director in compliance with any applicable state or federal regulations;

17. Wastewater that causes a hazard to human life or creates a public nuisance;

18. Wastewater containing toxic pollutants, gases, vapors, or fumes in sufficient quantity, which either singly or by interaction with other pollutants, may injure or interfere with any wastewater treatment process, cause acute worker health and safety problems, constitute a hazard to humans or animals, create a toxic effect in the receiving waters of the city's sanitary sewer system, result in exceedances of biosolids disposal restrictions, or exceed the limitation set forth in a pretreatment standard or requirement. A toxic pollutant shall include, but not be limited to, any pollutant identified pursuant to section 307(a) of the Act;

19. Stormwater, rainwater, groundwater, street drainage, subsurface drainage, yard drainage, and cooling water, including evaporative type air cooler discharge water and noncontact cooling water;

20. Wastewater containing sulfides in sufficient quantity or strength as to cause or contribute to corrosion in the city's sanitary sewer system or violations of the city's NPDES permit; or

21. Discharges which, if otherwise disposed of, would be a hazardous waste under 40 CFR Part 261.

Pollutants, substances, or wastewater prohibited by section 15.40.021 of this chapter shall not be processed or stored in such a manner that they could be discharged into the city's sanitary sewer system.

(Ord. 2481 §1 (part))

15.40.022 National categorical pretreatment standards.

Users must comply with the categorical pretreatment standards found in 40 CFR Chapter I, Subchapter N, sections 405-471, as amended.

Upon the promulgation of categorical pretreatment standards for a particular industrial subcategory, the categorical pretreatment standards, if more stringent than limitations imposed under this chapter for sources in that subcategory, shall immediately supersede the limitations imposed under this chapter. The director shall attempt to notify all known affected users of the applicable reporting requirements under 40 CFR Part 403.12, or other applicable pretreatment requirements. Provided, however, that in no case shall the failure of the director to notify a user constitute a defense to noncompliance with any such requirement, statute or regulations, or to noncompliance with the provisions of this chapter.

Modifications to the categorical pretreatment standards may occur under the following situations:

1. Where the city's sanitary sewer system achieves consistent removal of pollutants limited by pretreatment standards, the director may apply to the Administrator for modification of specific limits in the pretreatment standards. Upon approval from the Administrator, the director may modify pollutant discharge limits in the pretreatment standards if the requirements contained in 40 CFR Part 403.7 are fulfilled.

2. When the limits in a categorical pretreatment standard are expressed only in terms of either the mass or the concentration of a pollutant in wastewater, the director may impose equivalent concentration or mass limits in accordance with 40 CFR Part 403.6(c).

3. When wastewater subject to a categorical pretreatment standard is mixed with wastewater not regulated by the same standard, the director shall impose an alternate limit, using the combined wastestream formula in 40 CFR Part 403.6(e).

4. A user otherwise classified as a CIU may obtain a variance from a categorical pretreatment standard if the user can prove, pursuant to the procedural and substantive provisions in 40 CFR Part 403.13, that factors relating to its discharge are fundamentally different from the factors considered by USEPA when developing the categorical pretreatment standard.

5. A CIU may obtain a net gross adjustment to a categorical pretreatment standard in accordance with 40 CFR Part 403.15.

(Ord. 2481 §1 (part))

15.40.023 State pretreatment standards.

Users must comply with all applicable state pretreatment standards.

(Ord. 2481 §1 (part))

15.40.024 Local limits.

The director is authorized to establish local limits pursuant to 40 CFR Part 403.5(c). Local limits are established to protect against pass through and interference. No wastewater discharge shall exceed the local limits as determined by the director pursuant to section 15R.40.010 of this code.

The local limits apply at the point where wastewater is discharged into the city's sanitary sewer system. The director may impose mass limitations in addition to or in lieu of the concentration-based limitations above.

The director may develop BMPs, by ordinance, or in wastewater discharge permits, to implement the local limits and

requirements of sections 15.40.020 and 15.40.021.

(Ord. 2481 §1 (part))

15.40.025 City's right of revision.

The city reserves the right to establish, by ordinance or wastewater discharge permit, more stringent standards or requirements on discharges to the city's sanitary sewer system, if deemed necessary to comply with the objectives of this chapter or the Act.

(Ord. 2481 §1 (part))

15.40.026 Excessive discharge/dilution.

No user shall increase the use of process water or in any way attempt to dilute a discharge as a partial or complete substitute for adequate treatment to achieve compliance with the discharge limitations contained in the pretreatment standards or requirement.

The director may impose mass limitations on users who are using dilution to meet applicable pretreatment standards or requirements, or in other cases when the imposition of mass limitations is appropriate.

(Ord. 2481 §1 (part))

ARTICLE III. PRETREATMENT OF WASTEWATER

15.40.027 Pretreatment facilities.

Users who are CIUs, SIUs, or who are required by the director to obtain an industrial wastewater discharge permit shall provide wastewater pretreatment as necessary to comply with this chapter and shall achieve compliance with all categorical pretreatment standards and pretreatment requirement, local limits, and the prohibitions of this chapter within the time limitations specified by USEPA, the state, or the director, whichever is more stringent. Any facilities necessary for compliance shall be provided, operated, and maintained at the user's expense. Detailed plans describing such facilities and operating procedures shall be submitted to the director for review, and shall be acceptable to the director before such facilities are constructed. The review of such plans and operating procedures shall in no way relieve the user from the responsibility of modifying such facilities as necessary to produce a discharge acceptable to the city under the provisions of this chapter. Subsequent changes in the pretreatment facilities or method of operation shall be reported to and acceptable to the director prior to the user's initiation of the changes.

(Ord. 2481 §1 (part))

15.40.030 Interceptors.

1. An interceptor shall be installed in a user's building sewer when in the opinion of the director it is necessary for the proper handling of wastewater containing grease or oil in excessive amounts, sand, grit or other harmful substances; except that such interceptors shall not be required for buildings used solely for residential purposes. Provided, however, that interceptors shall be constructed in any place or building having a capacity to serve group meals and in commercial and industrial cleaning facilities.

Where the director requires the installation of an interceptor by a user who is neither an SIU nor a CIU, the user shall also be required to obtain a pollution prevention permit. Typical users required to install an interceptor and obtain a pollution prevention permit include, but are not limited to, restaurants, cafes, lunch counters, cafeterias, bars and clubs; hotels, hospitals, sanitariums, factory or school kitchens, equipment repair shops, service stations, and other establishments where grease, oils, sand, or grit may be introduced into the city's sanitary sewer system in quantities that can obstruct the sewer or hinder wastewater treatment or private wastewater disposal.

2. All interceptors shall be of a type and capacity approved by the director and shall be so located as to be readily and easily accessible for cleaning and inspection. Interceptors shall be constructed of impervious materials capable of withstanding abrupt and extreme changes in temperature. They shall be of substantial construction, water-tight and equipped with easily removable covers which, when bolted in place, are gas- and water-tight. All interceptors shall be maintained by the user, at the user's expense, in continuously efficient operation at all times.

3. Each user shall regularly inspect, clean, and repair interceptors. Records of inspections, cleaning and repairs, and the costs associated with these actions shall be kept for a minimum of three (3) years and be made available for inspection by city personnel upon request. Debris from interceptors shall be disposed of through a licensed waste hauler. Waste disposal records, including receipts, shall be kept for a minimum of three (3) years and be made available for inspection by city personnel upon request.

4. All interceptors shall comply with the following standards:

- a. Plans shall be submitted to and approval obtained from the director prior to the installation of any interceptor.
- b. All drains from kitchen areas including pre-wash shall be connected to an interceptor. Toilets, lavatories and other sanitary fixtures shall not be connected to any interceptor.
- c. All fixtures discharging into an interceptor shall be individually trapped and vented in a manner approved by the director.
- d. Each interceptor shall be so installed and connected that it shall be at all times easily accessible for inspection, cleaning, and removal of the intercepted material.
- e. Interceptors shall be maintained in efficient operating condition by periodic removal of the accumulated materials. No such collected material shall be introduced into any drainage piping, public or private, or discharged to the city's sanitary sewer system.
- f. Each interceptor shall be constructed of durable materials satisfactory to the director and shall have a full-size gas-tight cover which can easily and readily be removed.
- g. Interceptors required by this chapter shall not be installed until the type and/or model has been subjected to, and has fully complied with, tests acceptable to the director. Where existing conditions are found acceptable as determined by the director, such facilities as presently exist will be allowed to remain in use. Whenever it shall come to the attention of the director that any interceptor is no longer acceptable or does not comply with the provisions of this section, the director shall suspend or revoke such approval and require corrective measures.

(Ord. 2481 §1 (part))

15.40.120 Accidental spill and slug discharge control plans.

1. The director shall evaluate whether each SIU needs an accidental spill and slug control plan or other action to control slug discharges. The director may require any user develop, submit for approval, and implement such a plan or take other such action that may be necessary to control slug discharges. Alternatively, the director may develop such a plan for any such user. An accidental discharge/slug discharge control plan shall address, at a minimum, the following:

- a. Description of discharge practices, including non-routine batch discharges;
- b. Description of stored chemicals;
- c. Procedures for immediately notifying the director of any accidental or slug discharge, as required by section 15.40.350; and
- d. Procedures to prevent adverse impact from any accidental or slug discharge. Such procedures include, but are not limited to, inspection and maintenance of storage areas, handling and transfer of materials, loading and unloading operations, control of plant site runoff, worker training, building of containment structures and equipment, measures for containing toxic organic pollutants, including solvents, and/or measures and equipment for emergency response.

2. Each user required to have an accidental spill and slug discharge control plan shall provide protection from spills or accidental discharges of prohibited materials or other substances regulated by this chapter. Facilities to prevent accidental discharge of prohibited materials shall be provided and maintained at the user's own cost and expense. Detailed plans showing facilities and operating procedures to provide this protection shall be submitted to the director for review, and shall be approved by the director before construction of the facility.

3. Each user required to have an accidental spill and slug discharge control plan shall permanently post a notice on a bulletin board or other prominent place within the user's place of business advising employees whom to call in the event of spill, slug discharge or an accidental discharge. Users shall ensure that all employees who may cause or suffer such spills or slug discharges to occur are advised of the emergency notification procedures.

(Ord. 2481 §1 (part))

15.40.140 Maintenance of side sewers.

All users shall keep that portion of their side sewer in good repair, at their own expense, and shall be liable for any damages which may result from their failure to do so.

(Ord. 2481 §1 (part))

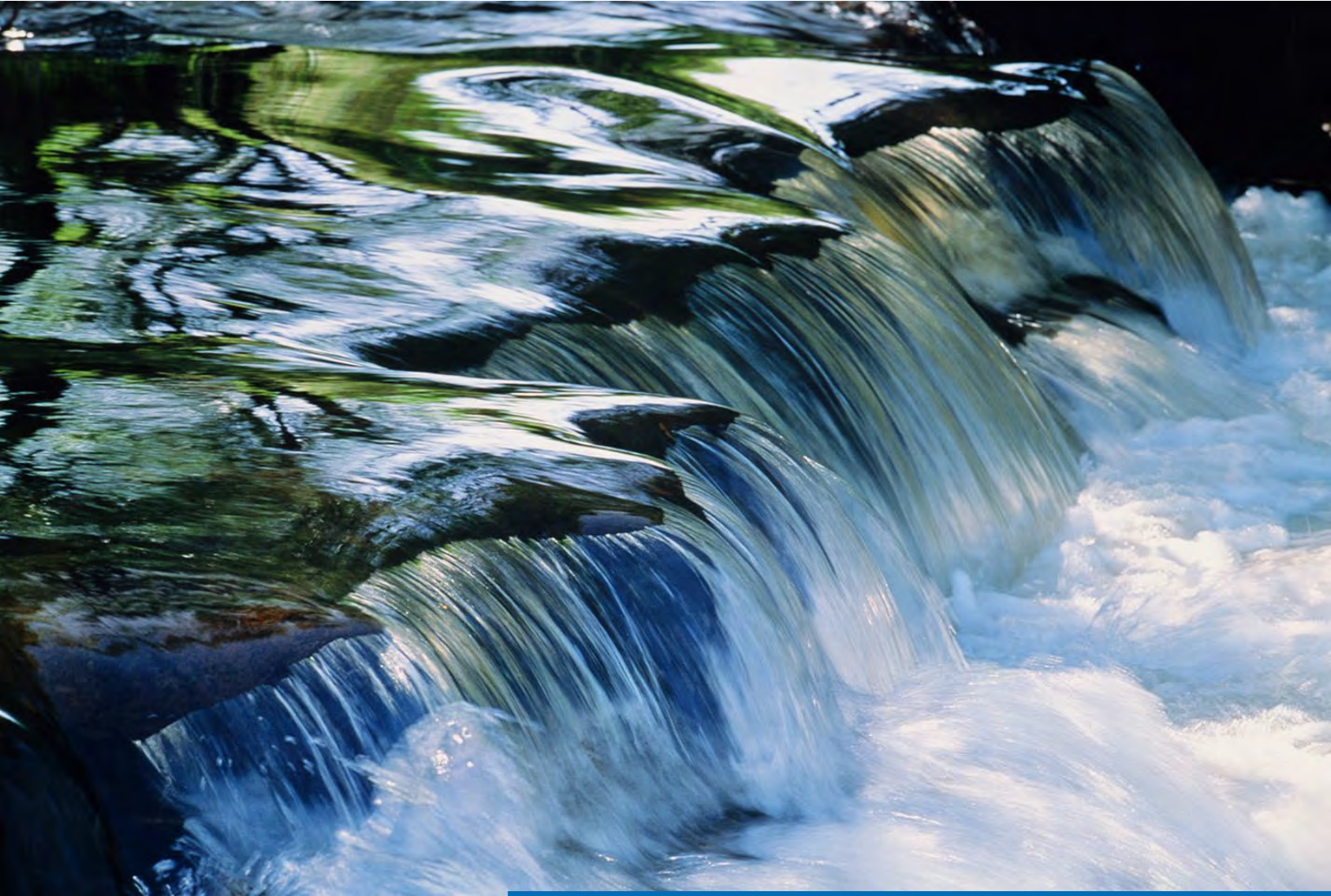

Regionalization Planning Report for the Paradise Sewer Project

Prepared under the Cooperative Funding
Agreement between the City of Chico and the
Town of Paradise

FINAL | May 2022



Exhibit C



City of Chico

Regionalization Planning Report for the Paradise Sewer Project

Prepared under the Cooperative Funding Agreement between the
City of Chico and the Town of Paradise

FINAL | May 2022



Contents

Chapter 1 - Executive Summary	1-1
1.1 Introduction	1-1
1.2 Background	1-1
1.2.1 Previous Planning Effort	1-1
1.2.2 Facility Improvement Categories	1-2
1.3 Summary of Capacity-Driven Facility Needs	1-2
1.4 Summary of Regulatory-Driven Facility Needs	1-3
1.5 Summary of Condition-Driven Facility Needs	1-4
1.6 Summary of Findings – Capital Needs	1-4
1.7 Connection Payment Calculation	1-6
Chapter 2 - Flows and Loads Analysis	2-1
2.1 Basis of Evaluation	2-1
2.2 Background	2-1
2.2.1 Previous WPCP Facility Planning	2-1
2.2.2 WPCP Service Area	2-2
2.3 Historical Population, Flows, and Loads	2-7
2.3.1 Historical Population	2-7
2.3.2 Historical Flows	2-11
2.3.3 Historical Wastewater Loads	2-15
2.4 Projected Population, Flows, and Loads	2-20
2.4.1 Projected Population	2-20
2.4.2 Projected Flows	2-25
2.4.3 Projected Loads	2-31
2.5 Summary of Projections	2-31
Chapter 3 - Plant Capacity Evaluation	3-1
3.1 Basis of Evaluation	3-1
3.1.1 Flow & Load Basis	3-1
3.1.2 Unit Process Availability Criteria	3-2
3.2 Background	3-2
3.2.1 Previous WPCP Facility Planning	3-2

3.2.2 WPCP Description	3-2
3.3 Peak Hydraulic Capacity Evaluation	3-15
3.3.1 Headworks	3-15
3.3.2 Primary Treatment	3-15
3.3.3 Primary Effluent Pumping	3-15
3.3.4 Secondary Treatment and Disinfection	3-16
3.3.5 Peak Hydraulic Capacity Analysis Summary	3-16
3.4 Treatment Process Capacity Evaluation	3-17
3.4.1 Primary Treatment Facilities	3-17
3.4.2 Secondary Treatment Facilities	3-18
3.4.3 Disinfection	3-21
3.4.4 Solids Handling	3-22
3.5 Summary of WPCP Capacity Limitations	3-24
Chapter 4 - Capacity-Driven Facility Needs	4-1
4.1 Approach	4-1
4.2 Headworks	4-1
4.3 Primary Clarification	4-1
4.4 Primary Effluent Pumping	4-5
4.5 Secondary Treatment Facilities	4-5
4.5.1 Near-Term Improvements	4-6
4.5.2 Options for Secondary Treatment Expansion	4-9
4.6 Disinfection and Dechlorination	4-22
4.6.1 Solids Handling	4-25
4.7 Summary of Capacity-Driven Facility Needs	4-25
Chapter 5 - Regulatory-Driven Facility Needs	5-1
5.1 Existing Discharge Requirements	5-1
5.1.1 Status of NPDES Permit Order	5-3
5.2 Previous Projection of Regulatory-Driven Facility Needs at the WPCP	5-3
5.3 Revised Schedule and Sizing Criteria	5-5
5.4 Updated Projection of Regulatory-Driven Facility Needs at the WPCP	5-6
5.4.1 Required Improvements for Land Discharge	5-6
5.4.2 Tertiary Treatment	5-13

5.4.3 Requirements for DEHP, Lead, and Zinc Compliance	5-19
5.4.4 Alternative Disinfection	5-19
Chapter 6 - Condition-Driven Facility Needs	6-1
6.1 Summary of Near-Term Condition Driven Needs	6-1
6.2 Summary of Long-Term Condition Driven Needs	6-3
6.3 Options for Reduced or Deferred Capital Expenditure	6-4
6.4 Development of Condition-Driven Project Packages	6-4
6.5 Summary of Condition-Driven Project Costs	6-4
Chapter 7 - Facility Improvement Recommendations	7-1
7.1 Summary of Capacity-Driven Projects	7-1
7.1.1 Limitations of Capacity Analysis	7-2
7.2 Summary of Regulatory-Driven Projects	7-3
7.2.1 Limitations of Regulatory Analysis	7-4
7.3 Summary of Condition-Driven Projects	7-4
7.3.1 Limitations of Condition Analysis	7-7
7.4 Capital Improvement Project Summary	7-7

Appendices

Appendix A Cost Estimates

Appendix B Daily Data

Tables

Table 1.1	Summary of Capacity-Driven Facility Needs	1-2
Table 1.2	Summary of Recommended Project and Project Costs	1-4
Table 1.3	Summary of Recommended Project and Project Costs	1-4
Table 1.4	Summary of Recommended Project and Project Costs	1-5
Table 2.1	Historical Population Estimates	2-7
Table 2.2	Historical College Student Total and Connected Population Estimates	2-9
Table 2.3	Estimated Connected Population vs College Breaks	2-13
Table 2.4	Summary of Annual Growth Rate Projections	2-21
Table 2.5	Connected Population Growth Projections	2-22
Table 2.6	Connected Chico and Paradise Residents	2-24
Table 2.7	Summary of Historical and Projected Population, Flows, and Loads	2-35

Table 3.1	Projected WPCP Flows & Loads	3-2
Table 3.2	Historical WPCP Capacity Ratings and Flow Split	3-3
Table 3.3	Hydraulic Capacity Summary for WPCP Major Processes	3-16
Table 3.4	Modeling Scenarios	3-17
Table 3.5	Summary of Capacity-Driven Facility Needs	3-25
Table 4.1	Secondary Treatment Facility Improvements	4-6
Table 4.2	Option 1 Component Costs	4-13
Table 4.3	Option 2 Component Costs	4-17
Table 4.4	Option 3 Component Costs	4-21
Table 4.5	Disinfection System Improvement Costs	4-25
Table 4.6	Summary of Capacity-Driven Facility Needs	4-26
Table 5.1	Current Effluent Limitations for Effluent Discharge to the Sacramento River	5-2
Table 5.2	Future Effluent Limitations for Land Discharge	5-3
Table 5.3	Summary of Probable Future Effluent Limitations	5-4
Table 5.4	Cloth Disk Filter Design Criteria	5-15
Table 5.5	UV Facility Design Criteria	5-21
Table 6.1	Summary of Near-Term Plant 2 Condition-Driven Needs	6-2
Table 6.2	Summary of Long-Term Plant 2 Condition Needs	6-3
Table 7.1	Secondary Treatment Facility Expansion Options	7-1
Table 7.2	Summary of Capacity-Driven Facility Needs	7-2
Table 7.3	Summary of Regulatory-Driven Facility Needs	7-3
Table 7.4	Summary of Near-Term Condition-Driven Facility Needs	7-5
Table 7.5	Summary of Long-Term Condition-Driven Facility Needs	7-6
Table 7.6	Summary of Recommended Project and Project Cost	7-8

Figures

Figure 2.1	City of Chico Sphere of Influence & Planning Area	2-3
Figure 2.2	Town of Paradise Sewer Service Area and Proposed Export Pipeline	2-4
Figure 2.3	WPCP Service Area Population Details	2-5
Figure 2.4	Historical ADWF and ADWF Per Capita Range	2-12
Figure 2.5	Historical ADWF vs. College Breaks and Estimated ADWF per Capita	2-13
Figure 2.6	Historical Flow Parameters and Peaking Factors	2-14

Figure 2.7	Historical Sierra Nevada Brewery Loads	2-16
Figure 2.8	Historical TSS Loads	2-17
Figure 2.9	Historical BOD Loads	2-17
Figure 2.10	Historical NH3 Loads	2-18
Figure 2.11	Historical Max Month Loads	2-19
Figure 2.12	Historical Max Month Load Peaking Factors	2-20
Figure 2.13	Historical Population Growth	2-21
Figure 2.14	Projected Flows	2-27
Figure 2.15	Projected ADWF	2-29
Figure 2.16	Projected Loads	2-33
Figure 3.1	WPCP Site Map with Facility Pond Locations	3-5
Figure 3.2	Existing WPCP Treatment Works and Facility Buildings	3-7
Figure 3.3	Existing WPCP Hydraulic Profile	3-9
Figure 3.4	Existing Liquids Flow Schematic for WPCP	3-11
Figure 3.5	Existing Solids Flow Schematic for WPCP-This Page Intentionally Left Blank	3-13
Figure 4.1	Primary Clarifier #4	4-3
Figure 4.2	Fourth Secondary Clarifier	4-7
Figure 4.3	Secondary Expansion (Option 1)	4-11
Figure 4.4	Secondary Expansion (Option 2)	4-15
Figure 4.5	Secondary Expansion (Option 3)	4-19
Figure 4.6	Chlorine Contact Basin	4-23
Figure 5.1	Emergency Effluent Bypass, Storage, and Return Improvements	5-7
Figure 5.2	Process Conversion from Nitrifying Activated Sludge to Modified Ludzack-Ettinger	5-11
Figure 5.3	Configuration of Basic Disk Filter	5-14
Figure 5.4	Potential Layout for Disk Filter Facilities at WPCP	5-17
Figure 5.5	Potential Layout for UV Disinfection Facilities at the WPCP	5-23
Figure 7.1	Projected Capital Investment by Spending Category	7-10
Figure 7.2	Total Annual Capital Spending through Planning Horizon	7-11

Abbreviations

AA	average annual
AAF	Average Annual Flow
AAFPF	AAF Peaking Factor
ADWF	average dry weather flow
BOD	biochemical oxygen demand
BOD ₅	biochemical oxygen demand
CCBs	chlorine contact basins
City	City of Chico
CSU	California State University
CT	chlorine contact
DAFT	dissolved air flotation thickener
DBP	disinfection byproducts
DEHP	Di-2-ethylhexyl phthalate
EPA	Environmental Protection Agency
gpcd	gallons per capita day
gpd/ft ²	gallons per day per square foot
gph	gallons per hour
gpm	gallons per minute
hp	horsepower
HRT	hydraulic residence time
lb/day	pounds per day
MG	million gallons
mg/L	milligrams per liter
mgd	million gallons per day
mL	milliliter
ML	mixed liquor
MLE	Modified-Ludzack Ettinger
MLR	mixed liquor recycle
MM	maximum monthly
MMF	maximum month flow
MMFPF	maximum month flow peaking factor
MPN	most probable number
NH ₃	ammonia
NPDES	National Pollutant Discharge Elimination System
Paradise	Town of Paradise

PF	peak flow
PFPF	peak flow peaking factor
psig	pounds per square inch gauge
PSRP	Process to Significantly Reduce Pathogens
RAS	return activated sludge
RWQCB	Regional Water Quality Control Board
SBS	sodium bisulfite solution
SCADA	supervisory control and data acquisition
scfm	standard cubic feet per minute
SHS	sodium hypochlorite solution
SIU	significant industrial user
SNB	Sierra Nevada Brewery
SOI	sphere of influence
SRPAC	Sewer Regional Project Advisory Committee
SVI	sludge volume index
SWRCB	State Water Resources Control Board
TSS	total suspended solids
UV	ultraviolet
UVT	ultraviolet transmittance
WAS	waste activated sludge
WDR	waste discharge requirement
WPC	Water Pollution Control Plant

Chapter 1

EXECUTIVE SUMMARY

1.1 Introduction

The Town of Paradise (Paradise) has studied options for treatment and disposal of the wastewater produced within the Town's service boundary for many years, limited by high groundwater, lack of available land, and poor soils. The absence of a viable wastewater solution has restricted residential and commercial growth within the Town's sewer service area and has threatened underlying groundwater supplies due to imminent failure of aging septic systems.

The City of Chico (City) provides wastewater collection, treatment, and disposal service for residents within the City's service area. The City population grew by almost 20 percent in 2019 due to Camp Fire¹ victim relocations, but the City did not see a proportional revenue growth for increased wastewater flows due to limited housing supplies (more people were living in shared houses).

The Paradise Sewer Project is a wastewater regionalization project that creates a solution for Paradise's wastewater issues, in turn relieving some of the pressure that the City has remained under since the Camp Fire. The purpose of this report is to quantify the impact that the Paradise sewer connection would have on the City's WPCP, define the facility needs for increased treatment associated with the Paradise connection and the City's continued growth, and create a basis for negotiation of a connection payment between the City and Paradise.

1.2 Background

1.2.1 Previous Planning Effort

The City initiated a WPCP planning effort in 2018 to evaluate facility needs related to condition, capacity, and regulatory requirements (near- and longer-term) as a basis for adjustments to the City's sewer service rates. During completion of this effort, the City experienced several planning changes, including significant impacts related to the 2018 Camp Fire and the 2019 Coronavirus Pandemic. Planning efforts were eventually summarized in the WPCP Strategic Planning Report² in February 2021 as a means for jump starting the sewer service rate adjustments currently underway, but the findings of that report had limited use for this effort for several reasons:

- The baseline population used for planning was no longer accurate.
- The population growth projection assumption was inadequate based on recent observations by the City and an increase in planned development within the City's sphere of influence (SOI).

¹ The Camp Fire was the deadliest and most destructive wildfire in California's history, and the most expensive natural disaster in the world in terms of losses.

² (Carollo Engineers, Inc. 2021)

- Future sewer flows from the Town of Paradise had not been accounted for.
- Increased flows now expected from California State University, Chico which had not been accounted for.
- The planning period for the WPCP Strategic Planning Report³ effort only extended to 2040, while the planning period for the Paradise Sewer Project ended in 2057.

This report provides updated planning results that incorporate these changes, providing an updated basis for planning for the City and Paradise.

1.2.2 Facility Improvement Categories

There are three main categories related to facility improvements referenced within this planning document, each with differing project triggers and associated timelines. These project categories include:

- *Capacity-Driven Facility Needs*: Projects in this category include improvements required to extend both treatment capacity and hydraulic capacity to account for the total City and Paradise influent loading (discussed in Chapter 4).
- *Regulatory-Driven Facility Needs*: Projects in this category are predicated on potential water quality regulation requirements anticipated in future NPDES permit renewals (discussed in Chapter 5).
- *Condition-Driven Facility Needs*: Condition-driven facility needs were determined through completion of a detailed multidiscipline condition assessment conducted April 25 to 26, 2018 (summarized in Chapter 6).

The previous planning effort also included a detailed “strategic planning” effort based on the City’s goals for sustainability and long-term resilience. Those findings are not adjusted in this report but should be revisited as the City gets closer to implementation of a chosen alternative.

1.3 Summary of Capacity-Driven Facility Needs

Table 1.1 includes a summary of recommended projects based on anticipated capacity-driven facility needs through 2057, along with predicted timelines for implementation of each and planning level construction and project cost estimates (presented in December 2021 dollars).

Table 1.1 Summary of Capacity-Driven Facility Needs

Projected Timeline for Implementation	Project Description	Estimated Construction Cost ⁽¹⁾⁽²⁾	Estimated Project Cost ⁽¹⁾⁽³⁾
2028	Secondary Clarifier #6 ⁽⁴⁾ (fourth clarifier in Plant 2)	\$8,000,000	\$10,700,000
2032	Supplemental Carbon Project	\$300,000	\$400,000
2033	Chlorine Contact Basin	\$4,100,000	\$5,100,000
2033	Chemical Storage and Feed Facility Improvements (SHS and SBS)	\$1,300,000	\$1,600,000

³ (Carollo Engineers, Inc. 2021)

Projected Timeline for Implementation	Project Description	Estimated Construction Cost ⁽¹⁾⁽²⁾	Estimated Project Cost ⁽¹⁾⁽³⁾
2036	Southern Pond Improvements for Secondary Expansion	\$700,000	\$900,000
2036	Secondary Clarifier #7 ⁽⁵⁾ (fifth clarifier in Plant 2)	\$10,000,000	\$13,400,000
2036	RAS/WAS Pump Station and Electrical Building ⁽⁶⁾	\$1,300,000	\$1,600,000
2038	Parallel Force Main Improvements	\$800,000	\$1,100,000
2039	Secondary Clarifier #8 ⁽⁵⁾ (sixth clarifier in Plant 2)	\$10,000,000	\$13,400,000
2044	Aeration Tank #5 ⁽⁷⁾	\$11,700,000	\$15,600,000
2044	Blower and Electrical Building ⁽⁶⁾	\$5,000,000	\$6,300,000
2044	Standby Generator	\$1,200,000	\$1,500,000
2045	Primary Clarifier #4	\$3,700,000	\$5,000,000
2053	Aeration Tank #6 ⁽⁷⁾	\$11,700,000	\$15,600,000
2054	Primary Effluent Lift Station Improvements	\$1,700,000	\$2,100,000
2054	Bar Screen #3	\$500,000	\$600,000
Total Required Capital Investment		\$72,000,000	\$94,900,000

Notes:

- (1) Costs are in December 2021 dollars based on ENR-CCI CCI of 12482.
- (2) Includes estimating contingency of 40% applied to total direct cost, general conditions and contractor overhead and profit contingencies at 18% of total direct cost (each), and local sales tax of 7.25% applied to half of the total direct cost.
- (3) Includes project cost factor of 35% for legal, administration, permitting, design, and engineering services during construction.
- (4) 100-foot diameter secondary clarifier.
- (5) 125-foot diameter secondary clarifier.
- (6) Based on Secondary Treatment Expansion Option 3 layout (Chapter 4).
- (7) With denitrification improvements (MLE).

1.4 Summary of Regulatory-Driven Facility Needs

Table 1.2 includes a summary of recommended projects based on reasonably anticipated regulatory-driven facility needs through 2057, along with predicted timelines for implementation of each, and planning level project cost estimates (presented in December 2021 dollars).

Table 1.2 Summary of Recommended Project and Project Costs

Projected Timeline for Implementation	Project Description	Estimated Construction Cost ⁽¹⁾⁽²⁾	Estimated Project Cost ⁽¹⁾⁽³⁾
2027	Emergency Effluent Bypass, Storage, and Return Improvements (NE Pond) ⁽⁴⁾	\$7,050,000	\$8,460,000
2032	Modified MLE process upgrades ⁽⁵⁾	\$3,620,000	\$4,350,000
2042	Tertiary Filtration Upgrades ⁽⁶⁾	\$16,830,000	\$22,710,000
2047	Alternate Disinfection ⁽⁷⁾	\$30,200,000	\$40,800,000
Total Required Capital Investment		\$57,700,000	\$76,320,000

Notes:

- (1) Costs are in December 2021 dollars based on ENR-CCI CCI of 12482.
- (2) Includes estimating contingency of 40% applied to total direct cost, general conditions and contractor overhead and profit contingencies at 18% of total direct cost (each), and local sales tax of 7.25% applied to half of the total direct cost.
- (3) Includes project cost factor of 35% for legal, administration, permitting, design, and engineering services during construction.
- (4) Includes pipeline between outfall box and Northeast Pond, a pump station for pump back to Headworks, and civil improvements to deepen the pond for 25 MG of storage.
- (5) In-basin improvements to existing aeration tanks in Plant 2.
- (6) Assumes cloth disk filtration, sized for peak flow at 39.6 mgd.
- (7) Assume UV disinfection, sized for peak flow of 39.6 mgd.

1.5 Summary of Condition-Driven Facility Needs

Table 1.3 includes a summary of total costs for near-term and long-term projects based on observed condition-driven needs at the facility through 2040 (presented in December 2021 dollars). Refer to Chapter 6 for additional details.

Table 1.3 Summary of Recommended Project and Project Costs

Projected Timeline for Implementation	Project Description ⁽¹⁾	Total Estimated Project Cost ⁽²⁾
<5 years	Near-term condition-driven projects	\$10,580,000
2025-2039	Long-term condition-driven projects	\$34,060,000
Total Required Capital Investment		\$44,640,000

Notes:

- (1) Refer to Chapter 6 for additional detail.
- (2) Costs are in December 2021 dollars based on ENR-CCI CCI of 12482.

1.6 Summary of Findings – Capital Needs

An assessment of the hydraulic and treatment capacity of existing facilities at the WPCP indicates that significant improvements will be required to accommodate projected increases in wastewater flow and loading over the planning horizon. Table 1.4 includes a summary of recommended projects to address capacity short-comings, along with condition-driven and regulatory-driven facility needs identified for the WPCP.

Table 1.4 Summary of Recommended Project and Project Costs

Projected Timeline for Implementation	Capacity Improvements	Project Driver	Estimated Project Cost ⁽¹⁾
2021	Aeration and Primary Treatment Upgrades Recommended by 2023 ⁽²⁾	Condition	\$1,870,000
2022	Disinfection, Chemical Building, Solids Thickening and Dewatering, Plant Power Systems, and Other Plant Systems Upgrades Recommended by 2023 ⁽²⁾	Condition	\$2,670,000
2023	Solids Digestion Upgrades Recommended by 2023 ⁽²⁾	Condition	\$2,370,000
2025	Primary Treatment Upgrades Recommended by 2025 ⁽²⁾	Condition	\$3,680,000
2025	Recycled Water Feasibility Study	Strategic	\$530,000
2027	Emergency Effluent Bypass, Storage, and Return Improvements	Regulatory	\$8,460,000
2027	Condition Driven Upgrades Recommended in 2027 ⁽²⁾	Condition	\$7,640,000
2028	Secondary Clarifier #6 ⁽³⁾ (fourth clarifier in Plant 2)	Capacity	\$10,700,000
2028	Condition Driven Upgrades Recommended in 2028 ⁽²⁾	Condition	\$3,240,000
2029	Condition Driven Upgrades Recommended in 2029 ⁽²⁾	Condition	\$5,390,000
2032	Modified MLE process upgrades	Regulatory	\$4,350,000
2033	Condition Driven Upgrades Recommended in 2033 ⁽²⁾	Condition	\$3,520,000
2032	Supplemental Carbon Project	Capacity	\$400,000
2033	Chlorine Contact Basin	Capacity	\$5,100,000
2033	Chemical Storage and Feed Facility Improvements (SHS and SBS)	Capacity	\$1,600,000
2036	Southern Pond Improvements for Secondary Expansion	Capacity	\$900,000
2036	Secondary Clarifier #7 ⁽⁴⁾ (fifth clarifier in Plant 2)	Capacity	\$13,400,000
2036	RAS/WAS Pump Station and Electrical Building ⁽⁵⁾	Capacity	\$1,600,000
2038	Parallel Primary Effluent Force Main Improvements	Capacity	\$1,100,000
2039	Secondary Clarifier #8 ⁽⁴⁾ (sixth clarifier in Plant 2)	Capacity	\$13,400,000

Projected Timeline for Implementation	Capacity Improvements	Project Driver	Estimated Project Cost ⁽¹⁾
2039	Condition Driven Upgrades Recommended in 2039 ⁽²⁾	Condition	\$10,460,000
2040	Anaerobic Digester 3 ⁽²⁾	Condition	\$3,800,000
2042	Tertiary filtration ⁽⁶⁾	Regulatory	\$22,710,000
2044	Aeration Tank #5 ⁽⁷⁾	Capacity	\$15,600,000
2044	Blower and Electrical Building ⁽⁵⁾	Capacity	\$6,300,000
2044	Standby Generator	Capacity	\$1,500,000
2045	Primary Clarifier #4	Capacity	\$5,000,000
2047	Alternate Disinfection ⁽⁶⁾	Regulatory	\$40,800,000
2053	Aeration Tank #6 ⁽⁷⁾	Capacity	\$15,600,000
2054	Primary Effluent Lift Station Improvements	Capacity	\$2,100,000
2054	Bar Screen #3	Capacity	\$600,000
Total Required Capital Investment			\$216,360,000

Notes:

- (1) Costs are in December 2021 dollars based on ENR-CCI CCI of 12482.
- (2) Refer to Chapter 6 for condition-driven project specific details.
- (3) 100-foot diameter secondary clarifier.
- (4) 125-foot diameter secondary clarifier.
- (5) Based on Secondary Treatment Expansion Option 3 layout (Chapter 4).
- (6) Sized for peak flow of 39 mgd.
- (7) With denitrification improvements (MLE).

1.7 Connection Payment Calculation

Various options for the calculation of a connection payment between Paradise and the City were evaluated by a working group that included team members from both agencies. The following three connection payment calculation options were presented for SRPAC consideration in January 2022:

1. **Option 1:** The ratio of total projected Paradise sewer flow (0.464 mgd) to the build-out flow projected for the WPCP (15.8 mgd) applied to each of the following (additive for total connection payment):
 - a. The calculated capacity-driven project cost.
 - b. The calculated condition driven project cost.
 - c. The estimated value of the existing WPCP Plant 2 facilities⁴.
2. **Option 2:** The calculated capacity-driven costs at the ratio of total projected Paradise sewer flow (0.464 mgal) to the added flow to build-out (7.4 mgd), plus the calculated condition-driven project costs at the ratio of the total projected Paradise sewer flow (0.464 mgd) to the current WPCP capacity (8.4 mgd).

⁴ Escalated from published Plant 2 valuation estimate in the Asset Valuation and Revenue Sufficiency Analysis (NHA Advisors, May 2016) using published historical average interest rates (2017-2021) and a projected average annual interest rate of 4.5% through December 2026.

3. Option 3: The calculated capacity-driven costs applied to the ratio of total projected Paradise sewer flow (0.464 mgd) to the added flow to build-out (7.4 mgd), plus the estimated value of the existing WPCP Plant 2 facilities applied to the ratio of the total projected Paradise sewer flow (0.464 mgd) to the current WPCP capacity (8.4 mgd).

In each case, the calculated costs were escalated from the December 2021 estimates to December 2026 projections, matching the planned timeline for sewer connection.

The third option was presented to the SRPAC in March 2022 as the recommended calculation methodology for the connection payment from Paradise to the City, with a draft total payment estimated at \$14.9 million (in December 2026 dollars). This methodology (and estimated connection payment value) was recorded in the draft Principles of Agreement, which is currently in final negotiation between Paradise and the City.

-This Page Intentionally Left Blank-

Chapter 2

FLOWS AND LOADS ANALYSIS

This Chapter presents an evaluation of historical wastewater flow and biochemical oxygen demand (BOD), total suspended solids (TSS), and ammonia loads entering the City of Chico's WPCP, and projections of future flow and load demands for the facility. Historical flow and loads are used to establish a baseline for flow and load projections used for planning of future facility needs.

2.1 Basis of Evaluation

The flow and load projections developed herein are based on an analysis of historical data reported during the period from May 2009 through May 2021. Historical flow and load data were compiled from WPCP operational observations and laboratory measurements (Appendix B). Other sources of data and information are cited throughout this Chapter.

These data were analyzed to develop baseline per-capita values for the average dry weather flow (ADWF) as well as the average annual (AA) load. Flow and load peaking factors were also developed from the analysis of the historical data. These per-capita values for ADWF and AA load were then used to develop projections through the end of the planning period, by applying the per-capita values to the projected population that would be contributing flow to the facility. Other flow and load parameters presented herein (e.g., maximum month) were projected by applying observed historical peaking factors to the projected ADWF and AA loads.

2.2 Background

2.2.1 Previous WPCP Facility Planning

Planning for WPCP facility needs has been accomplished in varying degrees since construction of the original facilities. The flow and load projections from the 2005 WPCP Facility Plan¹ are included herein for comparison to the updated projections developed for this effort. In the 2005 Facility Plan historical data between 1996 and 2001 was analyzed and the following flow projections were made:

- AA flows of 9 mgd in 2009.
- AA flows of 12 mgd in 2015.
- AA flows of 15 mgd at buildout.

These projections were made with the context of strong population growth assumptions (Table 2.4), significant industrial loading from Sierra Nevada Brewing Company (Section 2.3.3.1), and 100 percent connection of approximately 7,800 residences identified in the Nitrate Action Plan².

¹ (Carollo Engineers, Inc. 2005)

² (Butte County and City of Chico 1994)

An updated facility planning effort was initiated in 2018 to evaluate long-term facility needs related to condition, capacity, and regulatory requirements (near- and longer-term) as a basis for adjustments to the City's sewer service rates. During completion of this effort, the City experienced several planning changes, including significant impacts related to the Camp Fire in late 2018 and the COVID-19 pandemic beginning in late 2019.

That planning effort was eventually summarized in the WPCP Strategic Planning Report³ in February 2021 as a means for jump starting the ongoing sewer service rate adjustments.

The updated analysis presented herein reflects the City's effort to correct the previously unknown limitations reflected in the WPCP Strategic Planning Report⁴, which includes:

- An increase in the baseline population within the City's service area.
- Increased anticipated population growth rates.
- Increased flows due to planned development at the California State University, Chico.
- Increased sewer flows due to a possible future connection of the Town of Paradise sewer.

Updated WPCP needs presented herein are based on these updates, assume that the proposed connection of the Town of Paradise sewer to the City's WPCP will occur, and include planning through the year 2057 (to match the Town of Paradise planning period).

2.2.2 WPCP Service Area

As described in the Chico General Plan⁵, the City's planning efforts should address all land within the incorporated City limits, land within the City's designated sphere of influence (SOI), and other unincorporated land within Butte County (Figure 2.1). As discussed in Chapter 1, the Town of Paradise's new collection system is expected to be connected directly to the influent box at the WPCP by December 2026, at which point it will begin contributing to the WPCP's influent flow (Figure 2.2).

The WPCP is located approximately four miles southwest of downtown Chico and provides wastewater treatment and disposal services for most of the residences within the incorporated City of Chico and other residences in unincorporated areas of Butte County (Figure 2.3).

³ (Carollo Engineers, Inc. 2021)

⁴ (Carollo Engineers, Inc. 2021)

⁵ (City of Chico; PMC2017)

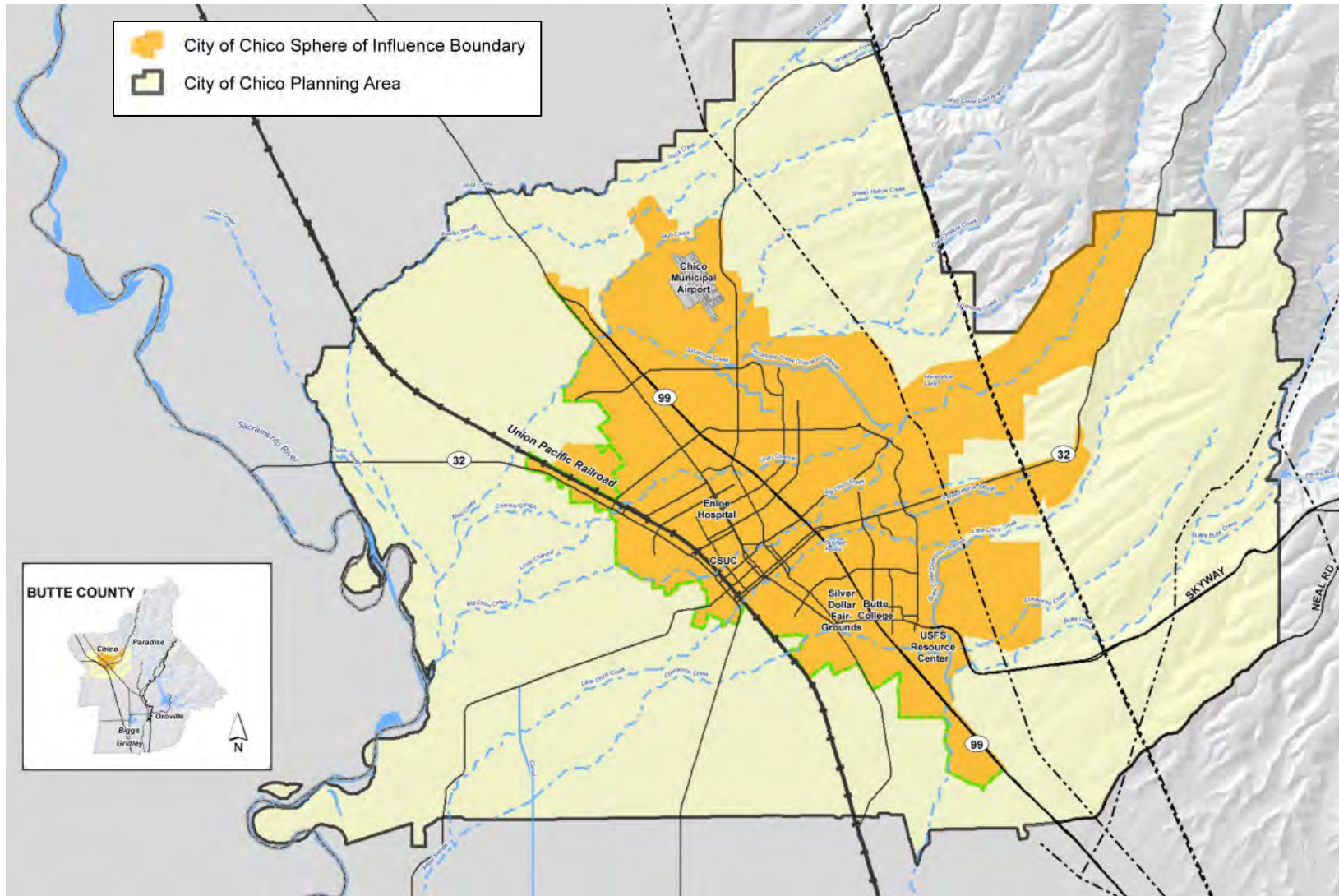

Figure 2.1 City of Chico Sphere of Influence & Planning Area

Image from City of Chico 2030 General Plan (City of Chico, 2021)

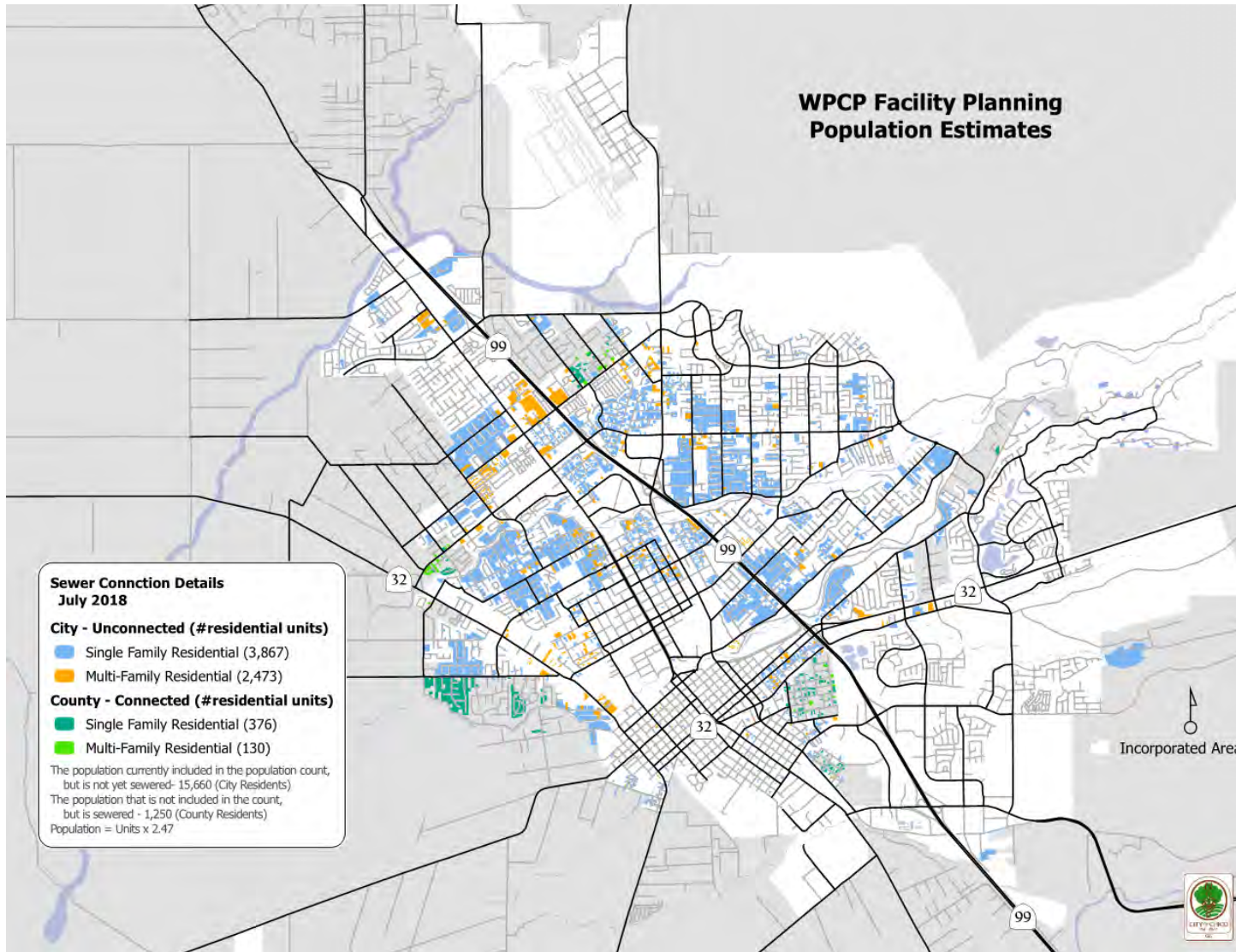

Figure 2.3 WPCP Service Area Population Details

Image received from the City of Chico (2021)

-This Page Intentionally Left Blank-

2.3 Historical Population, Flows, and Loads

Historical population, flow and load data are analyzed herein to develop ADWF and AA load per-capita values, as well as flow and load peaking factors.

2.3.1 Historical Population

Estimation of current per-capita wastewater flows (i.e., the volume of flow per person contributing to the total flow to the WPCP) is important because it provides a benchmark for future flow projections. It can also be compared to typical per capita flows to identify any collection system issues that may exist (e.g., flow due to infiltration and inflow).

To avoid over (or under) sizing future WPCP facilities, accurate per-capita values are needed. For true per-capita estimation, only the population connected to the WPCP collection system should be counted. Because the City population and the connected population are not equivalent, the connected population was estimated as follows:

$$2020 \text{ Population}_{total \text{ connected}} = 110,364 - 17,204 = 93,160$$

The estimated 2020 connected population represents about 84 percent of the estimated 2020 City population. This percentage was applied to historical City population estimates to develop historical connected population estimates (Table 2.1).

Table 2.1 Historical Population Estimates

Year	Estimated City Population ⁽¹⁾	Estimated Connected Population
2000	60,516	51,073
2001	64,810	54,697
2002	66,481	56,107
2003	67,862	57,273
2004	70,322	59,349
2005	72,459	61,152
2006	77,348	65,279
2007	82,784	69,866
2008	85,034	71,765
2009	85,739	72,360
2010	86,136	72,695
2011	86,707	73,177
2012	87,523	73,866
2013	88,127	74,376
2014	88,785	74,931
2015	89,615	75,631
2016	90,007	75,962
2017	91,166	76,940
2018	92,040	77,678
2019	110,126	92,942
2020	110,364	93,160

Notes:

(1) (State of California Department of Finance 2021).

2.3.1.1 Estimation of Full-Time Residents

The estimation of full-time residents is another key factor in the per-capita analysis for the City, due to the significant number of connected population that are college students (some of which are not full-time residents). Most of the students that live within the City's SOI are enrolled at the Chico campuses of California State University (CSU) (also known as CSU Chico or Chico State) or Butte College. The following enrollment data is available for these colleges:

- CSU Chico:
 - Total number of students.
 - Number of students that list Butte County as their residence.
- Butte College:
 - Total number of students.
 - Percentage of students that list the City of Chico as their residence.

The connected population when school is in session (which represents the maximum population during the calendar year) was estimated using the following assumptions:

- CSU Chico:
 - 100 percent of the students that listed Butte County as their residence remain in the service area during school breaks.
 - 100 percent of students that did not list Butte County as their residence leave the service area during school breaks.
- Butte College:
 - 100 percent of the students that listed the City of Chico as their residence remain in the service area during school breaks.
 - 100 percent of students that did not list the City of Chico as their residence leave the service area during school breaks.

In the case of Butte College, more enrolled students live in Chico than attend classes at the Chico campus (i.e., the connected population does not decrease when school is in-session). A slight decrease in flow may occur when these students are attending classes; however, most of their contribution to the collection system (from clothes washing, showers, dishwashers, etc.) is unaffected. A decrease in flow was not discernable from the data; therefore, the effect of Butte College breaks was presumed to be insignificant.

Accordingly, the connected population when school is on-break (which represents the minimum population during the calendar year) was estimated as follows:

$$Population_{On\ Break} = Population_{Total\ Connected} - Population_{CSU\ Chico\ non\ County}$$

The resulting Historical College Student Total and Connected Population Estimates are summarized in Table 2.2.

Table 2.2 Historical College Student Total and Connected Population Estimates

Year	CSU Chico Student Population ⁽¹⁾				Butte College Student Population			Estimated Connected Population	
	Total (Fall)	County	County %	non-County	Total (Fall) ⁽²⁾	City Residents ⁽³⁾	Chico Campus (Fall)	On-Break (Min) ⁽⁴⁾	In-Session ⁽⁵⁾
2000	15,912	4,418	27.8%	11,494	11,542	4,848	3,195	39,579	51,073
2001	16,704	4,573	27.4%	12,131	12,669	5,321	3,507	42,566	54,697
2002	16,246	4,534	27.9%	11,712	13,296	5,584	3,680	44,395	56,107
2003	15,516	4,371	28.2%	11,145	12,244	5,142	3,389	46,128	57,273
2004	15,734	4,343	27.6%	11,391	12,745	5,353	3,528	47,958	59,349
2005	15,919	4,161	26.1%	11,758	13,453	5,650	3,724	49,394	61,152
2006	16,250	4,016	24.7%	12,234	12,284	5,159	3,400	53,045	65,279
2007	17,034	3,933	23.1%	13,101	12,228	5,136	3,385	56,765	69,866
2008	17,132	3,811	22.2%	13,321	12,458	5,232	3,448	58,444	71,765
2009	16,934	3,729	22.0%	13,205	13,147	5,522	3,806	59,155	72,360
2010	15,989	3,419	21.4%	12,570	13,293	5,583	3,591	60,125	72,695
2011	15,920	3,381	21.2%	12,539	12,923	5,428	3,587	60,638	73,177
2012	16,470	3,326	20.2%	13,144	12,290	5,162	3,365	60,722	73,866
2013	16,356	3,202	19.6%	13,154	12,163	5,108	3,320	61,222	74,376
2014	17,287	3,226	18.7%	14,061	12,161	5,108	3,366	60,870	74,931
2015	17,220	3,080	17.9%	14,140	11,669	4,901	3,230	61,491	75,631
2016	17,557	3,081	17.5%	14,476	11,300	4,746	3,128	61,486	75,962
2017	17,875	3,001	16.8%	14,874	11,386	4,782	3,152	62,066	76,940
2018 ⁽⁶⁾	18,179	3,052	16.8%	15,127	11,580	4,863	3,205	62,551	77,678
2019 ⁽⁶⁾	18,488	3,104	16.8%	15,384	11,776	4,946	3,260	77,558	92,942
2020 ⁽⁶⁾	18,802	3,157	16.8%	15,646	11,977	5,030	3,315	77,514	93,160

Notes:

- (1) (The California State University 2018).
- (2) (National Center for Education Statistics 2018).
- (3) (Butte College 2016).
- (4) Calculated using equation described in Section 2.3.1.1.
- (5) From Table 2.1.
- (6) Estimation based on student population growth assumption of 1.7 percent to match population growth values used elsewhere. Does not reflect numbers reported by the university.

-This Page Intentionally Left Blank-

2.3.2 Historical Flows

Flow is defined as the volumetric rate at which raw influent wastewater enters the WPCP from the collection system, usually expressed in terms of millions of gallons per day (mgd). The WPCP influent flow measurement occurs downstream of screening and grit removal and prior to the introduction of plant recycle streams, tracked as a combination of flow measurements that occur in parallel Parshall flumes downstream of the grit removal facilities.

Daily minimum, maximum, and average flow data were compiled from monthly operational reports from January 2012 through December 2020 (the latest 9 full calendar years of data available) and analyzed to develop the flow parameters for each year as defined below:

- Average Dry Weather Flow (ADWF):
 - The ADWF is the average of daily average flows for the three-month dry weather period (July through September) each year.
 - ADWF per capita is the ADWF divided by the connected population, expressed in units of gallons per capita day (gpcd).
- Average Annual Flow (AAF):
 - The AAF is the average of average daily flows for the entire calendar year.
 - The AAF Peaking Factor (AAFPF) is AAF divided by the ADWF.
- Maximum Month Flow (MMF):
 - The MMF is the maximum 30-day running average of average daily flow data.
 - The MMF Peaking Factor (MMFPF) for each year is MMF divided by the ADWF.
- Peak Flow (PF):
 - The PF for each year is the maximum instantaneous flow measured by supervisory control and data acquisition (SCADA).⁶
 - The PF Peaking Factor (PFPF) for each year is PF divided by the ADWF.

Prior to developing these flow parameters, known erroneous data points and other statistical outliers (e.g., a PF on a dry summer day) were identified and removed (Appendix B).

2.3.2.1 Historical ADWF and ADWF per Capita

ADWF was calculated as described above, and an ADWF per capita range was calculated using the maximum and minimum connected population estimates from Table 2.2 (Figure 2.4).

⁶ Maximum influent flow reported on the monthly operational data sheets represents the maximum instantaneous flow, whose interval is subject to the PLC/SCADA programming. Hourly data prior to 2016 is not available due to a SCADA upgrade. Previous planning efforts expressed wet weather flow criteria in terms of peak hour wet weather flow (PHWWF).

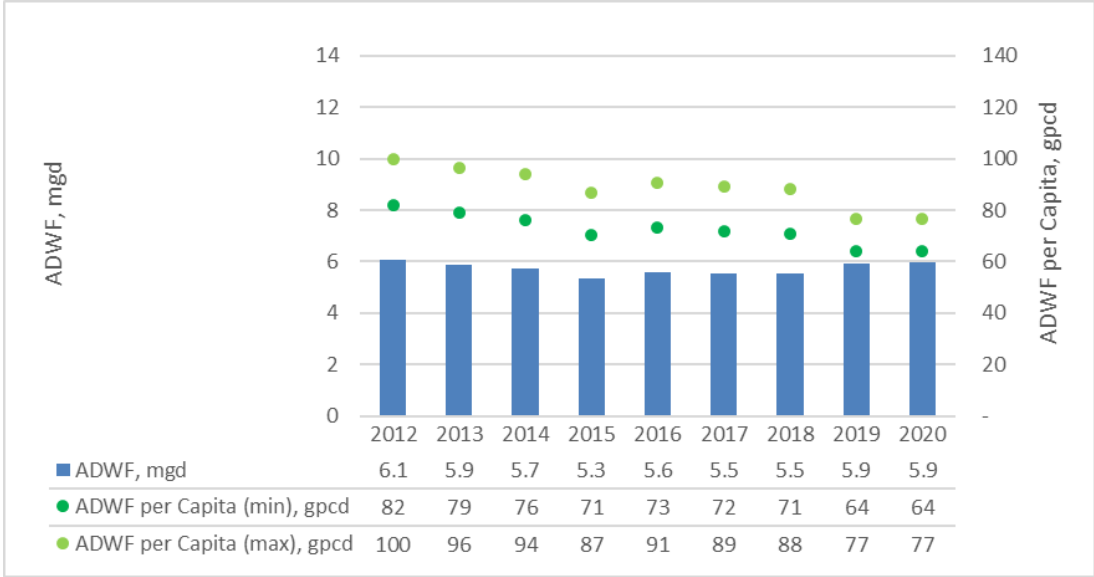

Figure 2.4 Historical ADWF and ADWF Per Capita Range

The upper bound of the ADWF per capita value represents the minimum year-round connected population estimate (assuming 100 percent of the non-local college students remain in the service area during school breaks, as described in Section 2.2). The lower bound ADWF per capita value represents the maximum year-round connected population estimate (assuming 100 percent of the non-local college students leave the service area during school breaks).

To better estimate the ADWF per capita value, flow data were compared with respect to the four major college breaks: spring break, summer break, Thanksgiving break, and winter break. Assuming students and non-students produce the same volume of wastewater when they are living in the service area, the ADWF per capita can be estimated algebraically:

$$\frac{n_{breaks}}{n_{total}} \cdot ADWF_{breaks} \cdot ADWF \text{ per capita} + \frac{n_{in-session}}{n_{total}} \cdot (Population_{total}) \cdot ADWF \text{ per capita} = ADWF_{total}$$

Where n is the number of days (either during a break or in-session) for the ADWF period each year; for 2012:

$$\frac{50}{84} \cdot 5.82 \text{ mgd} \cdot ADWF \text{ per capita} + \frac{34}{84} \cdot (73,866) \cdot ADWF \text{ per capita} = 6.05 \text{ mgd}$$

$$ADWF \text{ per capita} = 87 \text{ gpcd}$$

This calculation was applied to each year, with results summarized in Figure 2.5.

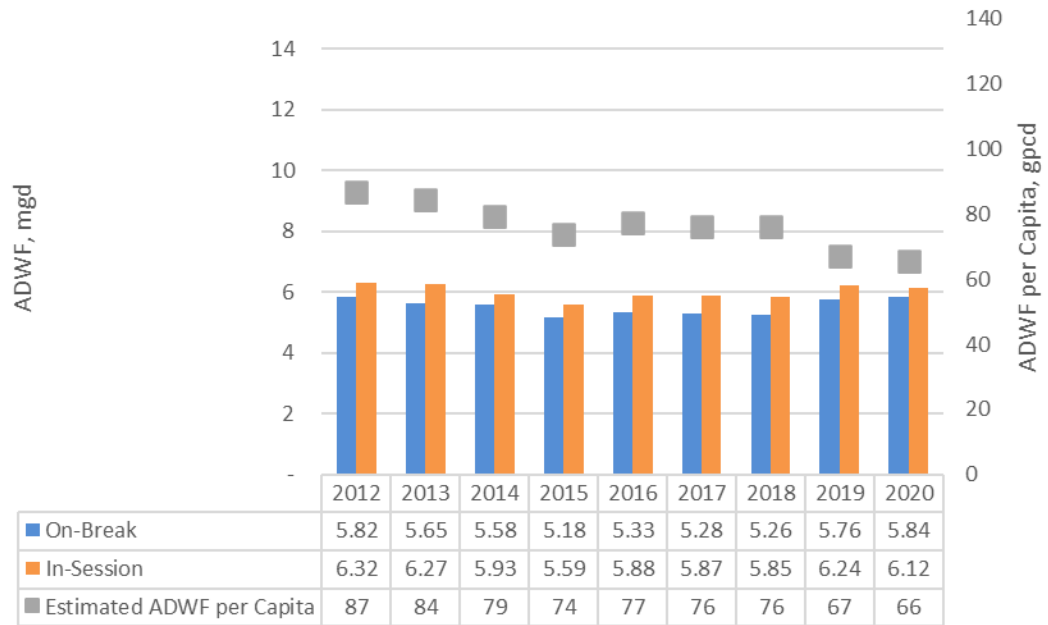

Figure 2.5 Historical ADWF vs. College Breaks and Estimated ADWF per Capita

From this ADWF per capita estimate, the population of students that leave during break can be more accurately estimated as follows:

$$(\text{Population}_{total} - \text{Population}_{students\ that\ leave}) \cdot \text{ADWF per capita} = \text{ADWF}_{breaks}$$

From this, the connected populations summarized in Table 2.2 were updated (Table 2.3).

Table 2.3 Estimated Connected Population vs College Breaks

Year	Connected Population, On-Break (Minimum) ⁽¹⁾	Connected Population, On-Break (Estimated)	Connected Population, In-Session (Maximum) ⁽¹⁾
2009	59,155	65,363	72,360
2010	60,125	67,682	72,695
2011	60,638	66,406	73,177
2012	60,722	67,265	73,866
2013	61,222	67,010	74,376
2014	60,870	70,571	74,931
2015	61,491	70,131	75,631
2016	61,486	68,881	75,962
2017	62,066	69,216	76,940
2018	62,551 ⁽²⁾	69,061	77,678
2019	77,558 ⁽²⁾	85,760	92,942
2020	77,514 ⁽²⁾	88,830	93,160

Notes:

(1) Copied from Table 2.2.

(2) Estimation based on student population growth assumption of 1.7 percent to match population growth values used elsewhere. Does not reflect numbers reported by the university.

For the period prior to 2018, approximately 54 percent of the non-resident students (non-City Butte College and non-County CSU Chico) left the service area over breaks (on average).

2.3.2.2 Other Historical Flows and Peaking Factors

Historical flow parameters are important for various planning, design, and operational purposes, a few of which are listed below⁷:

- **AA flows:** Used for estimation of pumping and chemical costs; can be used as a benchmark for comparison to similar plants for staffing purposes.
- **Maximum monthly (MM) flows:** Used to identify the required number and/or size of unit processes with large hydraulic retention; prevents overly conservative design.
- **Peaking factors:** Used for hydraulic design and sizing of more critical unit processes.

For each flow parameter, a historical flow peaking factor was developed that represents the ratio of that flow to the ADWF.

The WPCP historical flow parameters and associated peaking factors for 2012-2020 are presented in Figure 2.6.

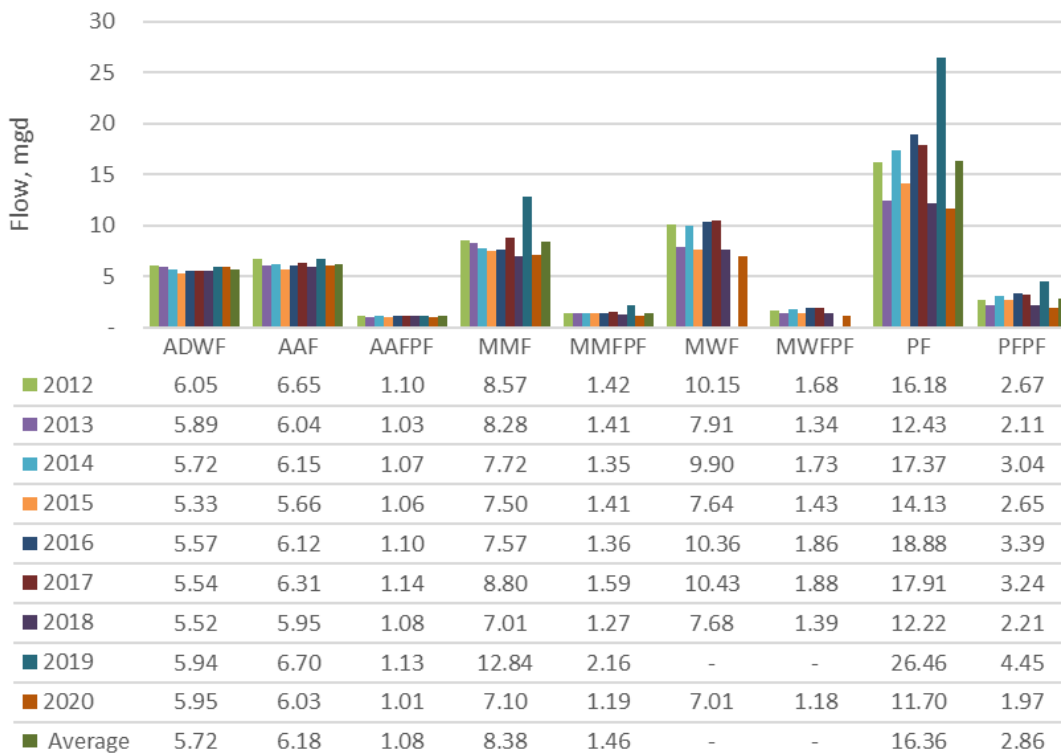

Figure 2.6 Historical Flow Parameters and Peaking Factors

⁷ (Tchobanoglous 2014)

The flow peaking factors are applied to the ADWF projections in the development of projections for the other flow parameters used for facility design (MMF and PF).

Because the historical PFs for this data set represent peak instantaneous flows, the PF peaking factors exceed the previously published peaking factor for the WPCP^{8,9} of 2.5. This past value reflects peak hour flow, which reflects a more realistic basis for capacity-related planning; the hydraulic design of the WPCP allows for some dampening of instantaneous flow impacts. Therefore, a flow peaking factor of 2.5 (matching historical practices) was chosen for this planning effort.

2.3.3 Historical Wastewater Loads

Wastewater loads are defined as the quantities of pollutants carried by the wastewater as it enters a treatment facility, usually expressed in terms of pounds per day (lb/day). Important loading criteria (related to facility design) include:

- **Daily loads:** Daily loads calculated using the measured average daily flow and the measured daily concentration for each pollutant.
- **Annual average loads:** Average daily loads treated at a facility for the calendar year, based on measured loading values.

Loading values were calculated for the WPCP based on historical data discussed herein. No historical loading values were available for Paradise so it was assumed that wastewater from Paradise would have the same characteristics as the flow from Chico. Once calculated, statistical outliers were removed from each pollutant's dataset to account for possibly erroneous concentration measurements¹⁰.

2.3.3.1 Sierra Nevada Brewery Loads

The largest significant industrial user (SIU) in the WPCP's service area is the Sierra Nevada Brewery (SNB). Untreated brewery wastewater is typically high-strength, which can be a significant burden for wastewater treatment. The preparation of 2005 WPCP Facility Plan¹¹ was preceded by a significant uptick in the flow and loads discharged by SNB to the City's collection system (and ultimately treated by the WPCP). This directly impacted the load projections made during that facility planning effort.

Since the 2005 facility planning effort, SNB has installed pre-treatment systems for its brewery wastewater prior to its discharge to the City's collection system, which has significantly reduced SNB's load on the WPCP as indicated in Figure 2.7.

⁸ (Carollo Engineers, Inc. 2005)

⁹ (Carollo Engineers, Inc. 2013)

¹⁰ Outliers were removed from calculated loads rather than from measured concentrations. This is because a low concentration may appear to be a statistical outlier without flow context (i.e., rainfall can dilute a pollutant's concentration), but when taken in context with the associated high flow, the load is not a statistical outlier.

¹¹ (Carollo Engineers, Inc. 2005)

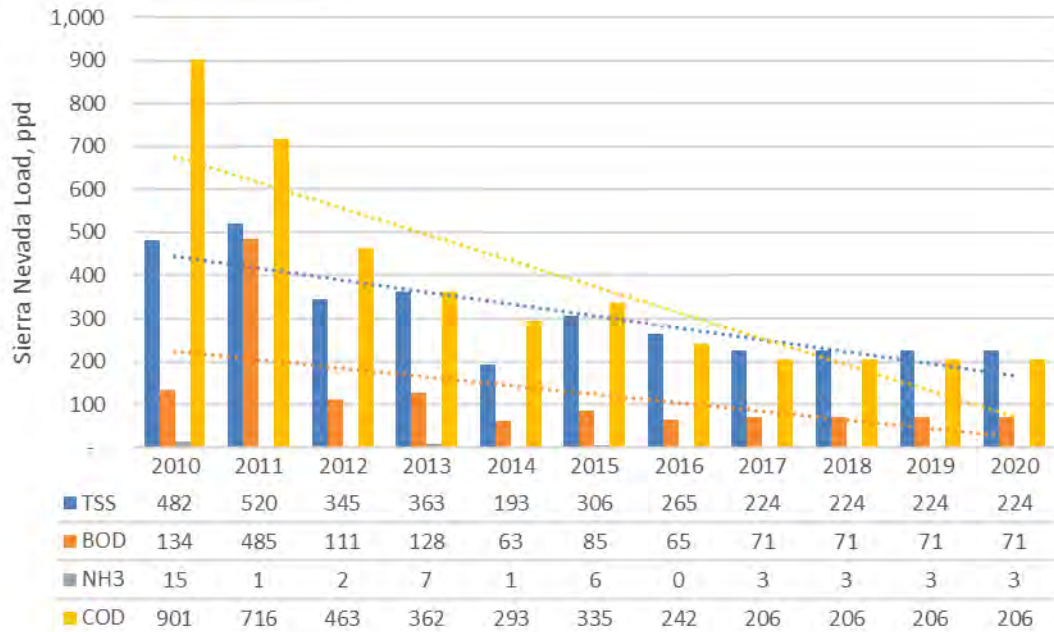

Figure 2.7 Historical Sierra Nevada Brewery Loads

Given the significant upgrades of SNB’s pretreatment systems and the measured downward trend of their loading on the WPCP, sampling frequency by SNB was reasonably decreased (the brewery’s effluent wastewater [load to the WPCP] has improved in quality over the time period analyzed).

To develop accurate per capita load values for the WPCP, the load associated with the brewery is differentiated from the rest of the total load measured at the plant (non-Sierra Nevada loads) in this evaluation. Since SNB data was not available after 2017, it was assumed for this analysis that 2018, 2019, and 2020 were identical to 2017.

2.3.3.2 Non-Sierra Nevada Loads and per Capita Values

Using the same methodology to capture college break and in-session population differences with a single per-capita value used for ADWF, AA load per capita values were calculated for TSS, BOD, and ammonia (NH₃) (Figure 2.8, Figure 2.9, and Figure 2.10).

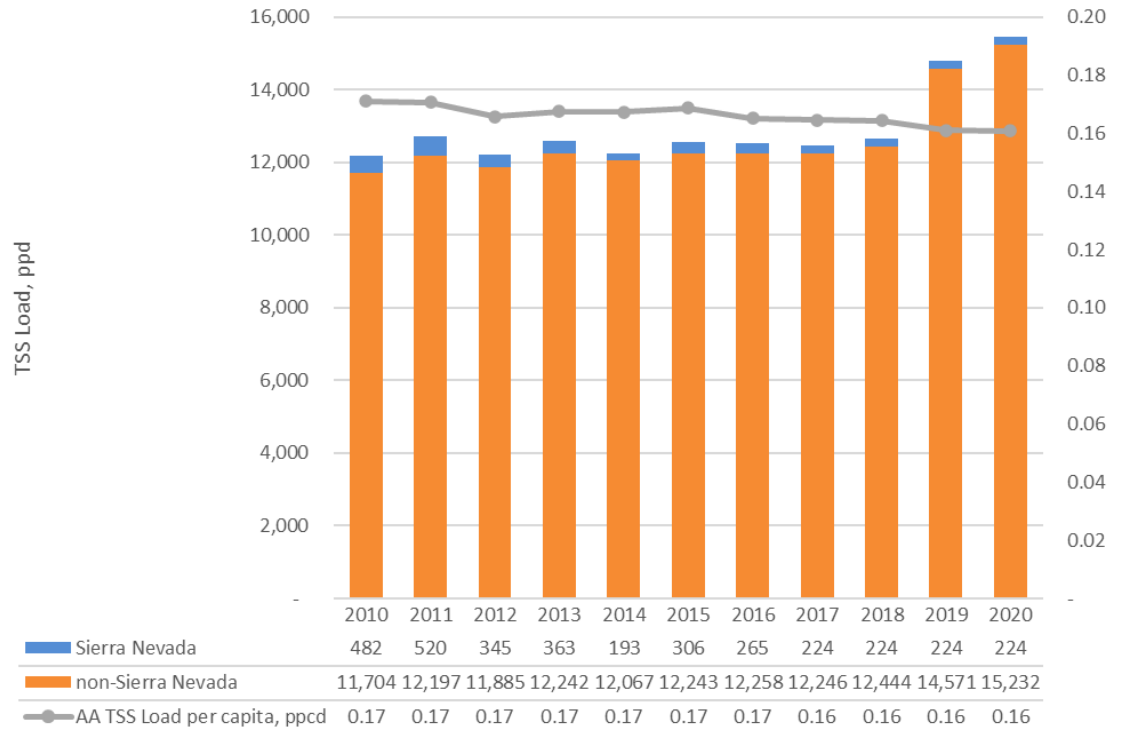

Figure 2.8 Historical TSS Loads

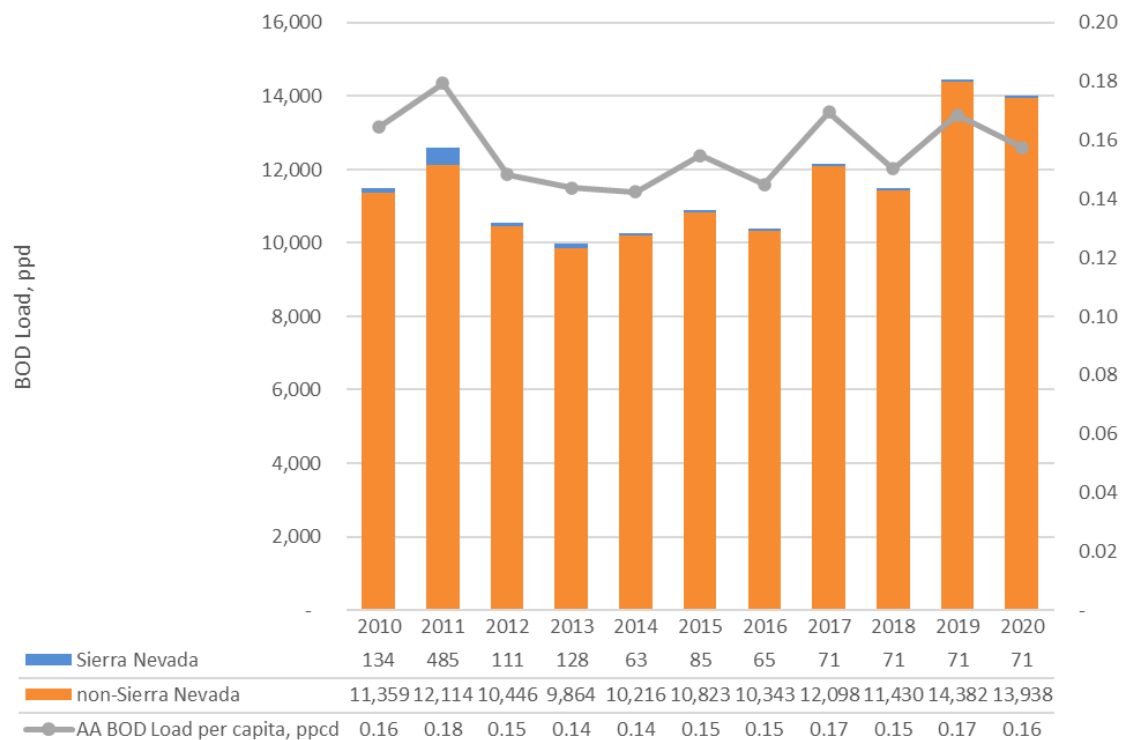

Figure 2.9 Historical BOD Loads

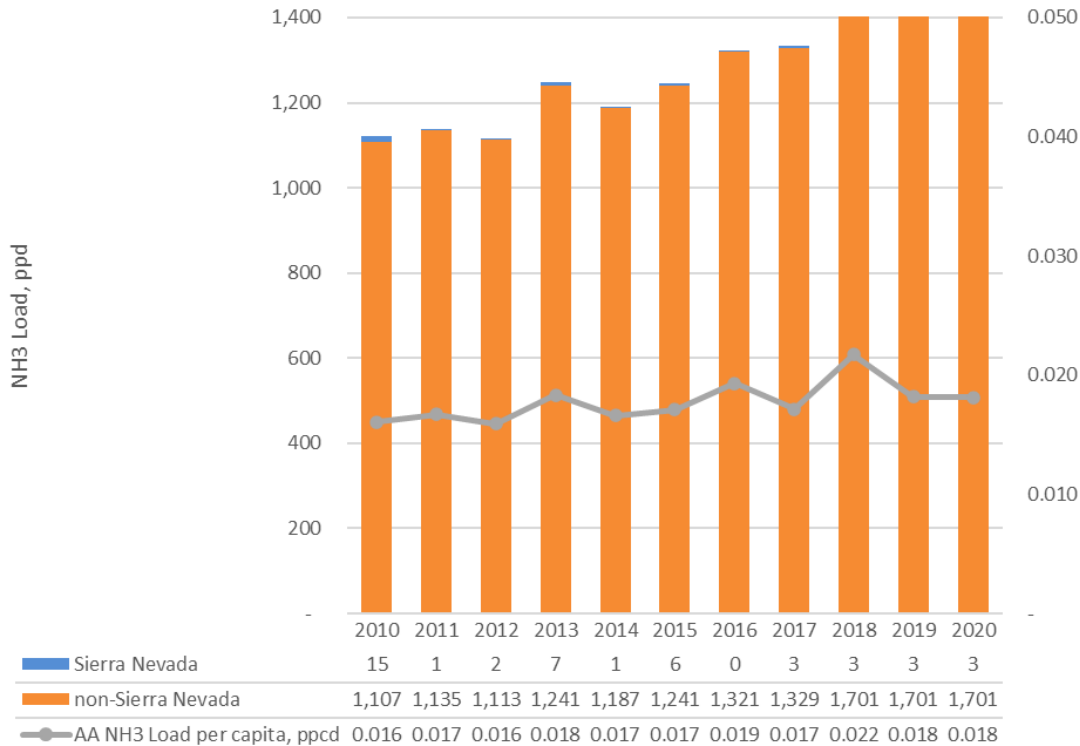

Figure 2.10 Historical NH₃ Loads

The per-capita ammonia load values reported in Figure 2.10 reflect the non-Sierra Nevada ammonia loading; Sierra Nevada's ammonia loading is shown only for comparison purposes. The average annual and per capita loads for NH₃ have trended upwards in recent years. However, the WPCP NH₃ data collected prior to 2018 was based on grab samples and all data since are based on 24-hour composite samples (depicting a more realistic daily concentration for the influent flow). For this reason, NH₃ data prior to 2018 was not used for future projections and is only presented herein for reference. Additionally, WPCP NH₃ data was not available for 2019 and 2020 so the 2018 loads were used in their place.

Historical maximum month values were calculated for non-Sierra Nevada loads (Figure 2.11) and peaking factors were calculated by dividing these loads by the average annual loads (Figure 2.12).

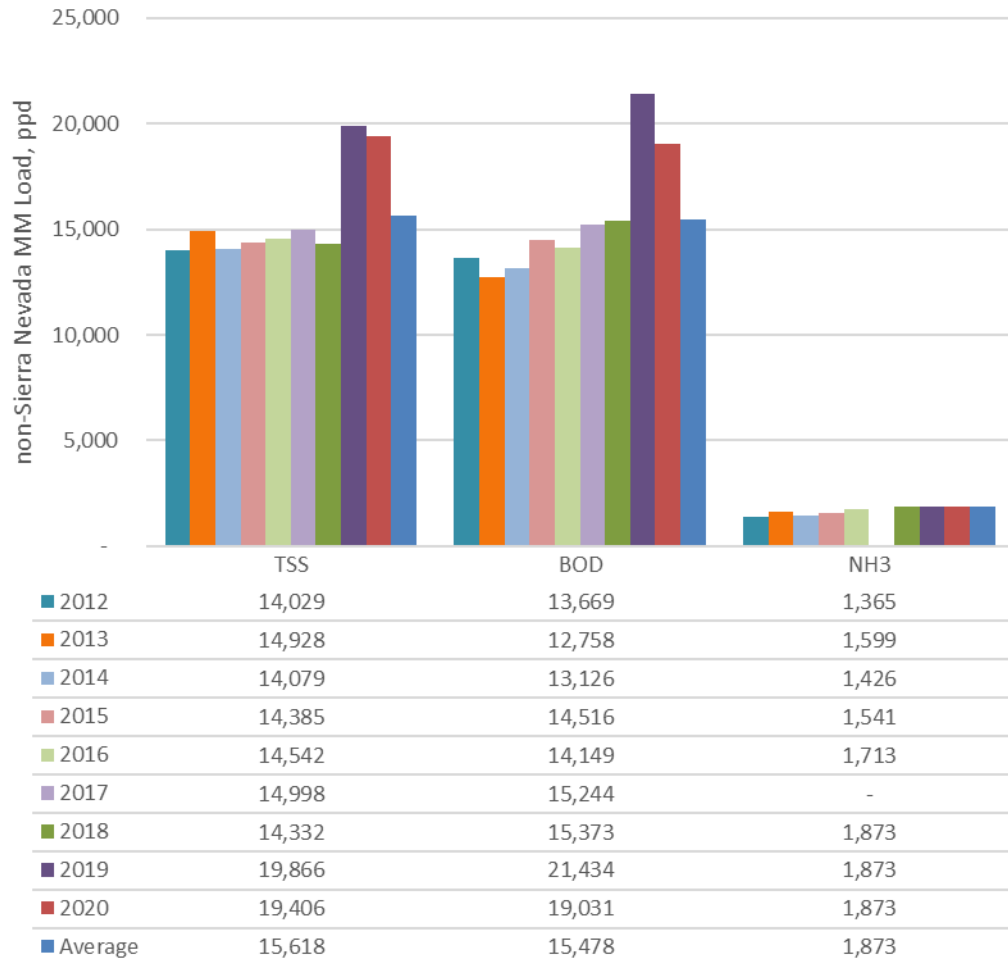

Figure 2.11 Historical Max Month Loads

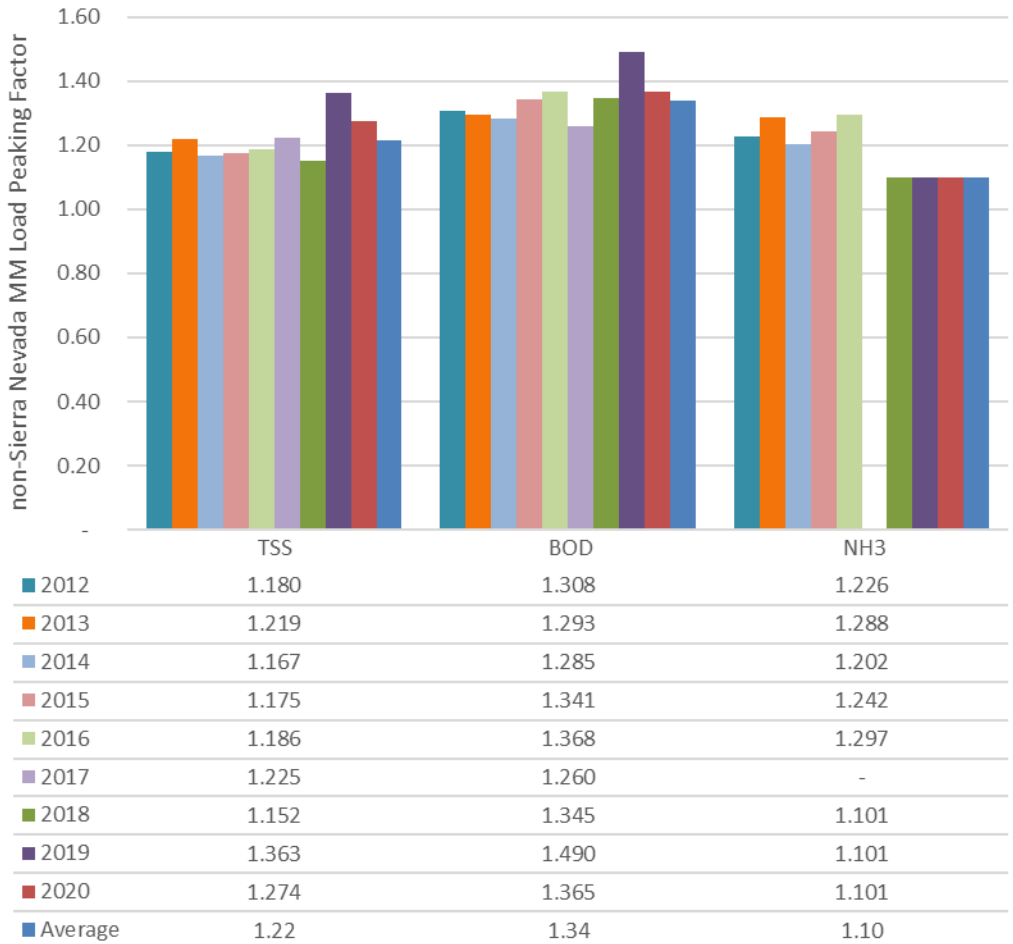

Figure 2.12 Historical Max Month Load Peaking Factors

2.4 Projected Population, Flows, and Loads

Population projections were created using historical trends and input from City staff. ADWF and AA load were projected by applying the developed per-capita values to the projected population. Other flow and load parameters were projected by applying the peaking factors to the projected ADWF or AA load.

2.4.1 Projected Population

Much of the City's population growth before 2009 was due to annexations related to the Nitrate Action Plan and other efforts undertaken by the City to consolidate its incorporated limits. As depicted in Figure 2.13, the Great Recession of 2008/2009 slowed this growth significantly with no notable increase until 2019. In 2019, the City saw a substantial increase in population growth following the Camp Fire, as Chico received an influx of displaced residents from the Town of Paradise.

There are currently several development efforts underway (and planned) within the City's SOI that will result in continued growth in the near-term.

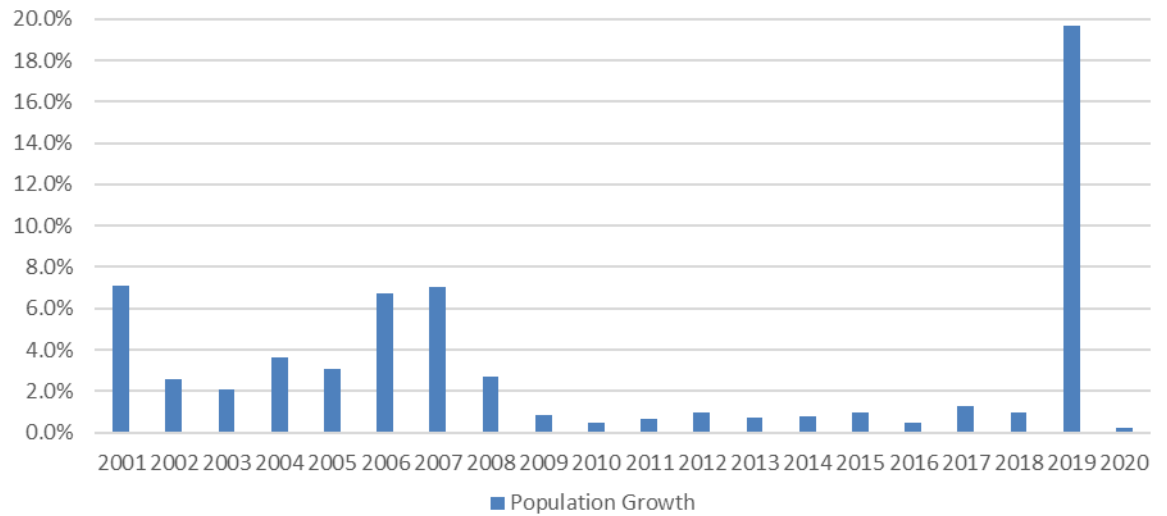

Figure 2.13 Historical Population Growth

Other historical planning efforts have assumed population growth rates that are higher than recently observed (Table 2.4).

Table 2.4 Summary of Annual Growth Rate Projections

Source	Year(s)	City	County
Facilities Plan	1996	2.9%	-
General Plan Update	1998	2.9%	2.5%
Facilities Plan Update	2005	2.5%	-
BCAG	2014	1.2-1.6%	1.2-1.6%
CADOF	2015	-	0.53%
General Plan Update	2017	1.7%	1.6%
Observed Historical	2009-2018	0.83%	0.44%
WPCP Strategic Planning Report		1.2 - 1.4%	-

The original WPCP Strategic Planning Report¹² assumed a growth rate of 1.2 percent, with an alternate growth rate assumption of 1.4 percent presented for comparison purposes, as requested by the City (Table 2.5).

For the updated analysis presented herein, a growth rate of 1.7 percent is used as directed by City staff. This growth rate matches the growth rate used for the 2017 General Plan Update and is intended to reflect expected and ongoing development activity within the City's SOI.

¹² (Carollo Engineers, 2021)

Table 2.5 Connected Population Growth Projections

Year	As Presented in WPCP Strategic Planning Report ⁽¹⁾				Current ⁽²⁾	
	1.2% Annual Growth		1.4% Annual Growth		1.7% Annual Growth	
	On-Break ⁽³⁾	In-Session	On-Break ⁽³⁾	In-Session	On-Break ⁽³⁾	In-Session
2018	70,826	77,938	70,812	77,938	-	-
2019	71,676	78,873	71,803	79,029	-	-
2020	72,536	79,820	72,808	80,136	88,830	93,160 ⁽⁴⁾
2021	73,494	80,778	73,930	81,257	88,235	95,474
2022	74,376	81,747	74,965	82,395	91,060	98,422
2023	75,357	82,728	76,119	83,549	93,936	101,423
2024	76,261	83,721	77,185	84,718	96,874	104,488
2025	77,266	84,725	78,371	85,904	99,874	107,618
2026	78,193	85,742	79,468	87,107	102,939	110,814
2027	79,222	86,771	80,687	88,326	107,496	115,505
2028	80,172	87,812	81,817	89,563	110,764	118,909
2029	81,226	88,866	83,071	90,817	114,105	122,389
2030	82,201	89,932	84,234	92,088	117,519	125,943
2031	83,280	91,011	85,523	93,378	120,426	128,993
2032	84,279	92,104	86,720	94,685	123,409	132,122
2033	85,385	93,209	88,046	96,010	126,460	135,322
2034	86,409	94,327	89,279	97,355	129,582	138,594
2035	87,541	95,459	90,642	98,718	132,776	141,941
2036	88,592	96,605	91,911	100,100	136,042	145,363
2037	89,751	97,764	93,312	101,501	139,384	148,863
2038	90,828	98,937	94,618	102,922	142,802	152,443

Year	As Presented in WPCP Strategic Planning Report ⁽¹⁾				Current ⁽²⁾	
	1.2% Annual Growth		1.4% Annual Growth		1.7% Annual Growth	
	On-Break ⁽³⁾	In-Session	On-Break ⁽³⁾	In-Session	On-Break ⁽³⁾	In-Session
2039	92,015	100,124	96,059	104,363	146,299	156,104
2040	93,125	101,326	97,423	105,824	149,877	159,848
2041	-	-	-	-	152,513	162,654
2042	-	-	-	-	155,199	165,512
2043	-	-	-	-	157,935	168,424
2044	-	-	-	-	160,723	171,390
2045	-	-	-	-	163,563	174,411
2046	-	-	-	-	166,457	177,489
2047	-	-	-	-	169,406	180,625
2048	-	-	-	-	172,410	183,821
2049	-	-	-	-	175,472	187,077
2050	-	-	-	-	178,593	190,395
2051	-	-	-	-	181,774	193,776
2052	-	-	-	-	185,016	197,222
2053	-	-	-	-	188,320	200,734
2054	-	-	-	-	191,689	204,314
2055	-	-	-	-	195,123	207,963
2056	-	-	-	-	198,625	211,683
2057	-	-	-	-	202,195	215,475

Notes:

- (1) Does not include Paradise residents.
- (2) Includes connected population from the Town of Paradise, as projected in Technical Memorandum #2 for the Paradise Sewer Project (Design Criteria for Local Wastewater Treatment Plant, HDR, November 2020).
- (3) Projected from Table 2.3 assuming college enrollment grows at the same rate as the non-student connected population.
- (4) Carried down from Table 2.1.

The remainder of this report, beginning with Table 2.6, assumes a singular growth rate assumption of 1.7 percent.

With use of the updated projection of 1.7 percent annual growth rate and the updated baseline population values for 2020 presented herein (which represent a 20 percent increase from the 2018 population estimate), the resulting connected population projection in the year 2057 is 215,475 residents. This represents a population increase of 131 percent from the 2020 baseline population, as anticipated growth within the Chico and Paradise service areas combined.

Annexations of unincorporated areas of Butte County (unincorporated islands within the City limits and developments outside of City limits) are included in this projection because these annexations have been captured in the historical data and because the rate of annexations is not expected to significantly change.

The updated population projections also include connected Paradise residents starting in 2027 (estimated connection to the WPCP is December 2026), and total 6,163 people by 2057 (Table 2.6). For the remainder of the discussion in this report, only the combined connected population is considered.

Table 2.6 Connected Chico and Paradise Residents

Year	Chico	Paradise ⁽¹⁾	Total Connected ^(2,3)
2020	93,160	1,200	93,160
2021	95,474	1,230	95,474
2022	98,422	1,260	98,422
2023	101,423	1,292	101,423
2024	104,488	1,324	104,488
2025	107,618	1,357	107,618
2026	110,814	1,391	110,814
2027	114,079	1,426	115,505
2028	117,412	1,497	118,909
2029	120,817	1,572	122,389
2030	124,293	1,651	125,943
2031	127,260	1,733	128,993
2032	130,302	1,820	132,122
2033	133,411	1,911	135,322
2034	136,588	2,006	138,594
2035	139,834	2,107	141,941
2036	143,151	2,212	145,363
2037	146,541	2,323	148,863
2038	150,004	2,439	152,443
2039	153,543	2,561	156,104
2040	157,159	2,689	159,848
2041	159,831	2,823	162,654
2042	162,548	2,964	165,512
2043	165,311	3,113	168,424

Year	Chico	Paradise ⁽¹⁾	Total Connected ^(2,3)
2044	168,121	3,268	171,390
2045	170,979	3,432	174,411
2046	173,886	3,603	177,489
2047	176,842	3,783	180,625
2048	179,848	3,973	183,821
2049	182,906	4,171	187,077
2050	186,015	4,380	190,395
2051	189,177	4,599	193,776
2052	192,393	4,829	197,222
2053	195,664	5,070	200,734
2054	198,990	5,324	204,314
2055	202,373	5,590	207,963
2056	205,814	5,869	211,683
2057	209,312	6,163	215,475

Notes:

(1) Connected Paradise residents were calculated using Paradise wastewater flows and per capita usage provided by HDR.

(2) From Table 2.5.

(3) Connected residents total does not include Paradise residents until the connection is online in 2027.

The total connected population projection of 215,475 represents a 131 percent increase from the 2020 connected population estimate.

2.4.1.1 Population Growth due to Connection of Unconnected City Residents

The number of currently unconnected City residents is a more significant portion of the overall population than the county annexations, and the historical rate of adding unconnected City residents is expected to be higher in the future as the implementation of the Nitrate Compliance Plan continues.

For this planning effort, it was assumed that 100 percent of the estimated 17,204 unconnected City residents will be connected by 2040; the number of residents connected annually is assumed to increase at the same rate as that of the currently connected population.

2.4.2 Projected Flows

In the dry weather months from which the ADWF per-capita value was derived, approximately 60 percent of the days are on-break days and 40 percent are in-session days. ADWF was projected by applying the average ADWF per-capita value (76.3 gpcd) proportionally to the break and in-session population projections as follows:

$$ADWF = 60\% \cdot ADWF \text{ per capita} \cdot Population_{on-break} + 40\% \cdot ADWF \text{ per capita} \cdot Population_{in-session}$$

Other flow parameters were projected by applying the flow peaking factors to the projected ADWF (Figure 2.14). As with Table 2.6, the ADWF flow projections for the total connected population can also be split between the Chico service area and the Paradise residents (Figure 2.15).

-This Page Intentionally Left Blank-

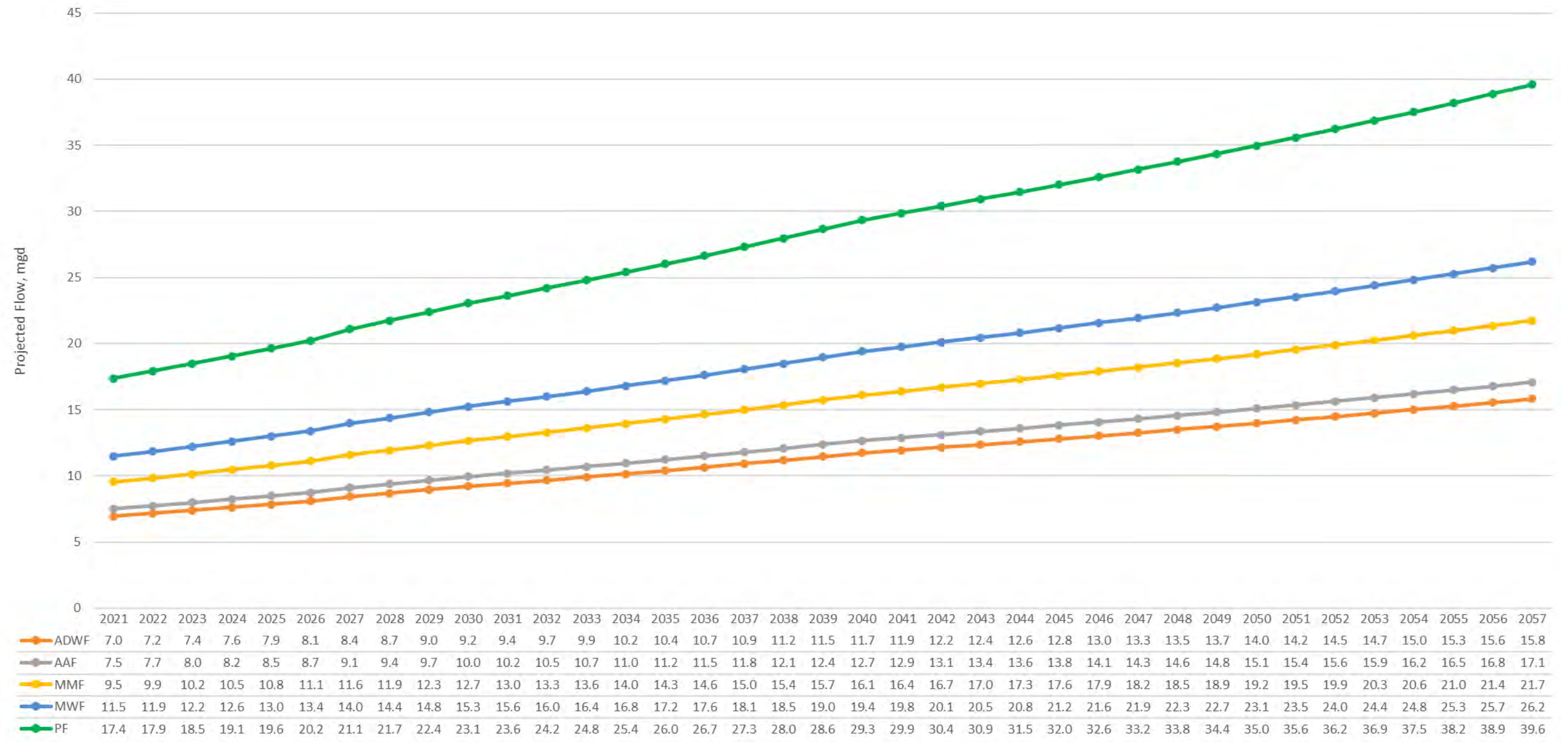

Figure 2.14 Projected Flows

-This Page Intentionally Left Blank-

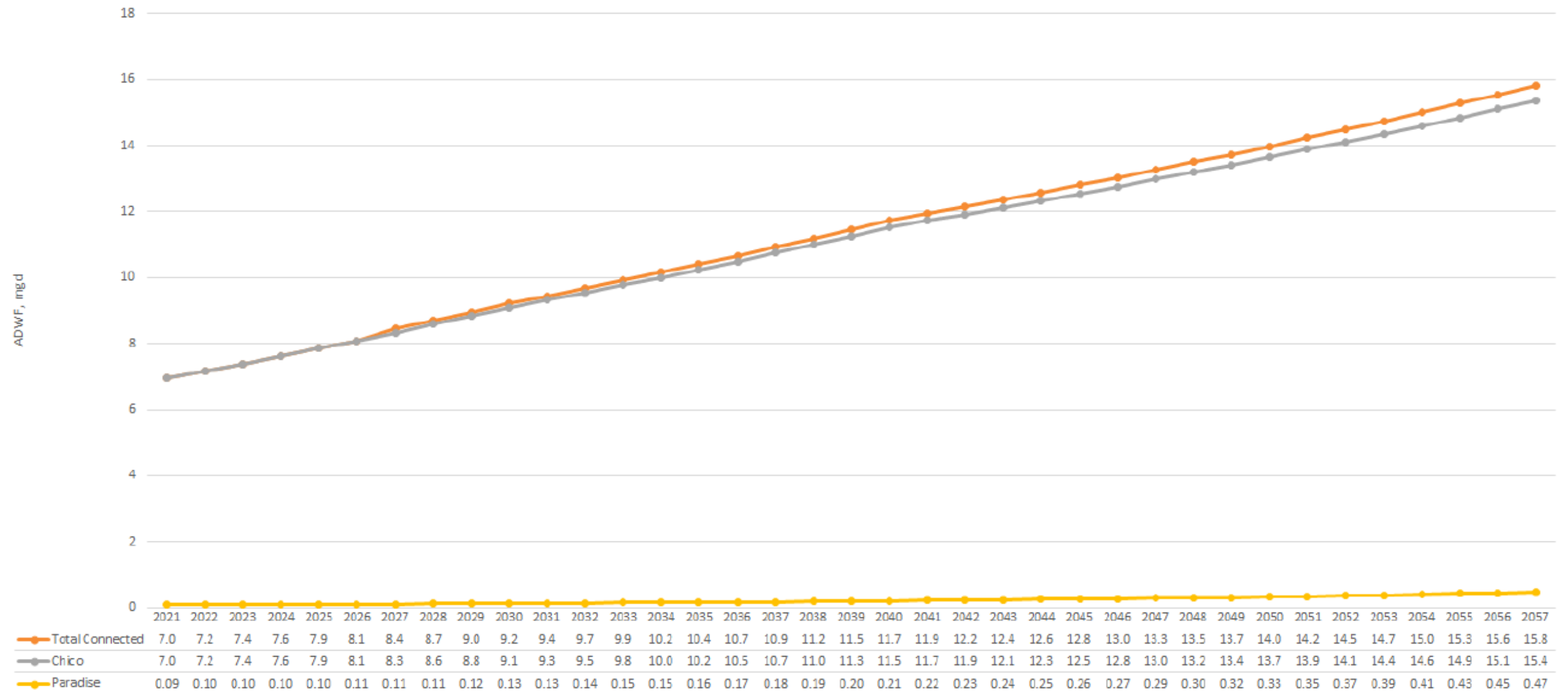

Figure 2.15 Projected ADWF

-This Page Intentionally Left Blank-

2.4.3 Projected Loads

Average annual loads were projected by applying the average annual per-capita values to the projected population. Because of the small and decreasing portion of Sierra Nevada's load to the overall influent load, the average loads for the time period analyzed were held constant for projected loads (Figure 2.16).

2.5 Summary of Projections

Table 2.7 contains a summary of historical and projected population, flow, and load values. Findings related to this data include the following:

- The population connected to the WPCP collection system is projected to increase 131 percent by 2057 (from 93,160 to 215,475).
- The ADWF for the WPCP is projected to increase 126 percent by 2057 (from 7.0 mgd to 15.8 mgd).
- Projected flows and loads are higher than previous projections:
 - Projected AA and MM flows are 14 percent and 12 percent higher than the previous facility plan's projections, respectively.
 - Projected AA and MM TSS loads are 17 percent and 31 percent higher than the previous facility plan's projections, respectively.
 - Projected AA and MM BOD loads are 30 percent and 45 percent higher than the previous facility plan's projections, respectively.

These flow and load projections provide context for the capacity-driven facility needs discussion in Chapter 4 and the regulatory-driven facility needs discussion in Chapter 5.

-This Page Intentionally Left Blank-

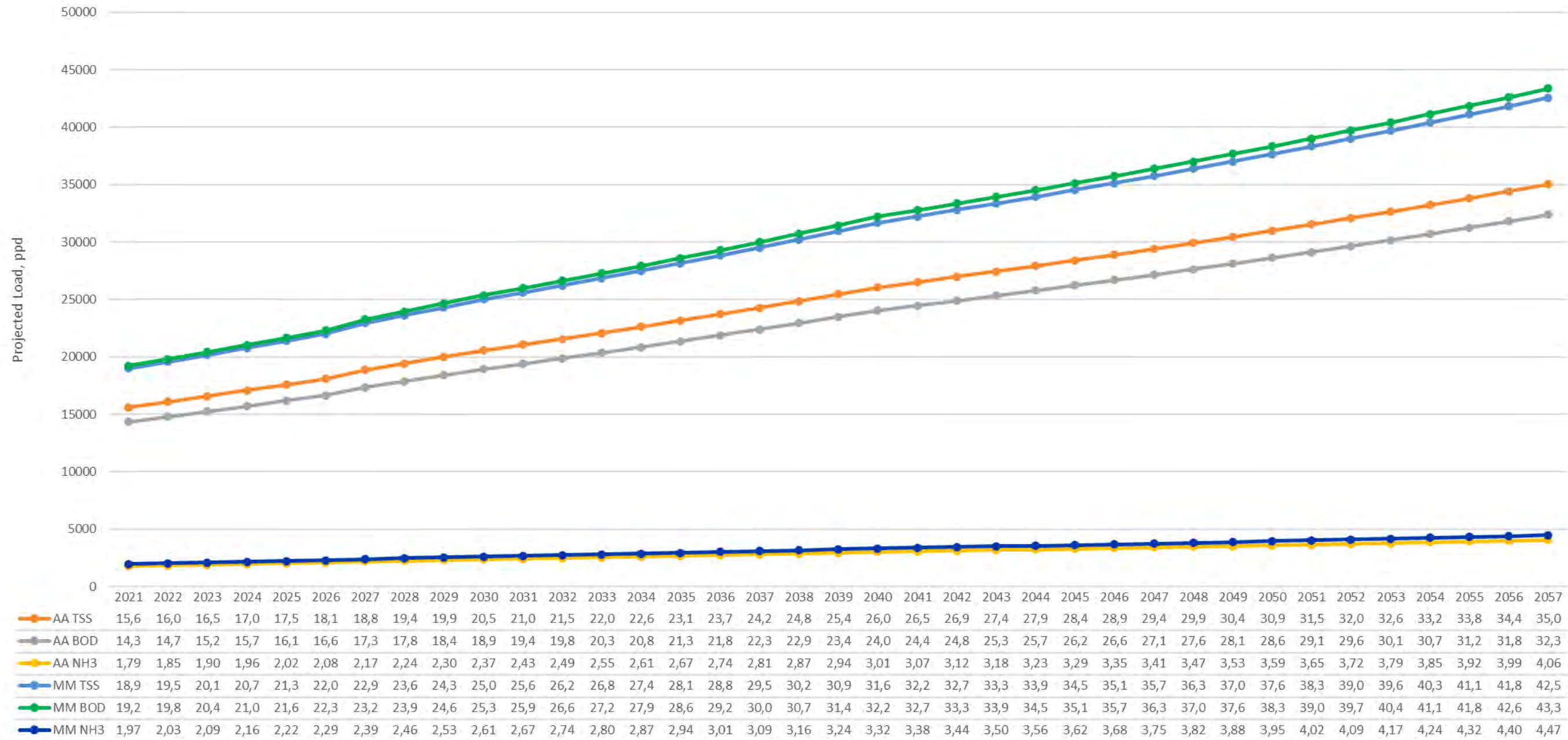

Figure 2.16 Projected Loads

-This Page Intentionally Left Blank-

Table 2.7 Summary of Historical and Projected Population, Flows, and Loads

Planning Parameter	Previously Projected				Updated Projection					Historical Projections ⁴	
	2018 Baseline ¹	2018 Peaking	2040 Projected	2040 Projection	2021 Baseline ²	2021 Peaking	2040 & 2057	2040 Projection	2057 Projection	2005 Facility Plan	2013 SSMPU
		Factor	PF (2018 BL)	(2018 BL)		Factor	Projected PF (2021 BL)	(2021 BL)	(2021 BL)	Projection	Projection
Connected Population³											
Annual Maximum	77,938	-	-	116,986	93,160	-	-	159,848	215,475	-	-
Annual Minimum	70,842	-	-	108,798	88,830			149,877	202,195	-	-
Average Dry Weather (ADW)											
Flow, mgd	5.91	-	-	9.39	5.72			11.74	15.83	-	13.91
Diurnal Peak Flow, mgd	8.22	1.39	1.39	13.05	7.95	1.39	1.39	16.30	21.98	20.30	-
AWDF per capita, gpcd	84	-	-	84	76			76	76	-	-
Annual Average (AA)											
Flow, mgd	6.35	1.09	1.09	10.23	6.18	1.08	1.08	12.68	17.10	15.00	-
TSS, ppd	12,443	-	-	19,379	13,062			26,064	35,028	30,000	
TSS per capita, ppcd	0.17	-	-	0.17	0.17			0.17	0.17	-	
BOD, ppd	11,051	-	-	17,861	11,586			24,050	32,379	25,000	
BOD per capita, ppcd	0.16	-	-	0.16	0.15			0.15	0.15	-	
NH3, ppd	1,214	-	-	1,972	1,705			3,019	4,069	-	
NH3 per capita, ppcd	0.02	-	-	0.02	0.02			0.02	0.02	-	
Maximum Month (MM)											
Flow, mgd	8.52	1.47	1.47	13.76	7.86	1.37	1.37	16.12	21.74	19.50	
TSS, ppd	14,672	1.21	1.21	23,499	15,618	1.22	1.22	31,687	42,585	32,500	
BOD, ppd	14,224	1.30	1.30	23,294	15,478	1.34	1.34	32,217	43,376	30,000	
NH3, ppd	1,512	1.27	1.27	2,501	1,873	1.10	1.10	3,323	4,479	-	
Peak											
Flow, mgd	15.86	2.74	2.50	23.48	16.36	2.86	2.50	29.34	39.58	37.50	35.30

Notes:

- (1) For the connected population, the baseline represents the estimated connected population at the beginning of 2018; for ADW, the baseline represents the historical average of the years 2009-2017; for all other parameters, the baseline represents the historical average of the years 2010-2017.
- (2) For the connected population, the baseline represents the estimated connected population at the beginning of 2021; for all other parameters, the baseline represents the historical average of the years 2012-2020.
- (3) The connected population is presented as a range for informational purposes only to reflect the biannual population swings due to college students; the flow and load projections use a blend of both population totals presented as described in this Chapter.
- (4) Historical projections were based on complete buildout of the City's Planning Area. The other projections in this table only extend to the end of the stated planning period (2040 or 2057).

-This Page Intentionally Left Blank-

Chapter 3

PLANT CAPACITY EVALUATION

This chapter evaluates the capacity of the City's WPCP to provide adequate treatment for the projected flows and loads within the planning period ending in 2057 (Chapter 2) in a tightening regulatory environment (Chapter 5).

Within this updated plant capacity evaluation there are several new capacity-driven upgrades identified that were not included in the recent WPCP Strategic Planning Report¹. The capacity-driven upgrades that had not been previously discussed are primarily the result of the three following circumstances:

- An increased population assumption compared to that used in the WPCP Strategic Planning Report².
 - The updated 2021 baseline population is approximately 20 percent higher than the previous 2018 baseline population.
- An increased growth rate assumption due to current development planning activity (1.7 percent compared to 1.2 percent used in the WPCP Strategic Planning Report³).
- An increase in planning period length (from ending in 2040 to ending in 2057) resulting a 35 percent increase in anticipated flows and loads since the previous planning effort.

3.1 Basis of Evaluation

Two parameters that were used to evaluate the WPCP's capacity are defined below:

- *Peak hydraulic capacity*: The maximum flow that can be physically passed through the treatment plant without over-topping structures or submerging effluent weirs. Evaluated with Carollo's Hydraulix® modeling software.
- *Treatment process capacity*: The maximum flow for the WPCP at which treatment objectives are accomplished for each process unit. Evaluated with BioWin™ wastewater process modeling software.

3.1.1 Flow & Load Basis

Annual average (AA) and maximum month (MM) flow and load projections form the basis for treatment process capacity evaluations. Peak flow projections provide the basis for peak hydraulic capacity evaluation. The flow and load projections for these analyses were developed in Chapter 2 and are summarized in Table 3.1.

¹ (Carollo Engineers, 2021)

² (Carollo Engineers, 2021)

Table 3.1 Projected WPCP Flows & Loads

Condition	Projected Flow ⁽¹⁾ , mgd	Projected Load ⁽¹⁾ , ppd (TSS / BOD / NH ₃)
Peak	39.6	-
MM	21.7	42,600 / 43,400 / 4,500
AA	17.1	35,100 / 32,400 / 4,100
Average Dry Weather (ADW)	15.8	-

Notes:

(1) Projection is based on the planning period which extends through 2057.

3.1.2 Unit Process Availability Criteria

Both capacity parameters (peak hydraulic capacity and treatment process capacity) were evaluated for each unit process based on a unit process availability criterion defined below:

- *Firm capacity/availability*: All units are in service (available) except the largest unit.
- *Total capacity/availability*: All units are in service (available).

These unit process criteria are used to evaluate individual unit process capacities as described herein. For all capacity ratings in this chapter, it is assumed that the flow distribution to each process is optimized and that individual units are receiving equal amounts of flow.

3.2 Background

3.2.1 Previous WPCP Facility Planning

The City's 2005 WPCP Facility Plan⁴ described two projects to expand the firm AA treatment process capacity of the plant to 12- and 15- mgd, respectively. Each project was developed to provide 2.5 times the AA flows in peak hydraulic capacity.

The 12 mgd upgrade project was constructed in 2007 and was comprised of hydraulic and process-related capacity improvements to several unit processes, however, the 15 mgd expansion project has not been implemented. As described in Chapter 2, AA flow is projected to surpass the WPCP's current design capacity of 12 mgd within the planning period.

3.2.2 WPCP Description

3.2.2.1 Split Flow Configuration

Influent wastewater flows through the Headworks and the primary treatment process at the WPCP by gravity. After primary treatment, primary effluent was historically split between two parallel trains (Plant 1 and Plant 2) that each consist of secondary treatment and disinfection processes.

Plants 1 and 2 were originally designed to receive approximately 30 percent and 70 percent of the total flow, respectively. However, as noted elsewhere in this report, the City is unable to consistently rely on aging Plant 1 facilities and is treating all flows with Plant 2 only. Plant 1 facilities are not discussed further in this report.

A summary of historical WPCP flow splits and capacity ratings is presented in Table 3.2.

⁴ (Carollo Engineers, Inc. 2005)

Table 3.2 Historical WPCP Capacity Ratings and Flow Split

Project (Year)	Shared - Primary, mgd	Plant 1 - Secondary & Disinfection, mgd (% of Total)	Plant 2 - Secondary & Disinfection, mgd (% of Total)	Total Design Capacity (AA), mgd	Total Peak Flow Capacity, mgd
12 mgd Expansion Project (2007)	12	3.6 (30%) ⁽¹⁾	8.4 (70%)	12	30
1997 Expansion Project (1997)	9	3.6 (40%) ⁽²⁾	5.4 (60%)	9	22.5
1990 Expansion Project	6	6 (100%)	-	6	15

Notes:

- (1) Plant 1 is currently not in use other than Aeration Tank #2, which is being used for centrate storage/return. Efforts would be needed to bring Plant 1 capacity back online.
- (2) Plant 1 was de-rated to 3.6 mgd in 1997 due to new nitrification requirements.

The locations of the major plant hydraulic components described in this chapter are depicted in the facility layouts included as Figures 3.1 and 3.2. The WPCP's existing hydraulic profile is Figure 3.3, and Figures 3.4 and 3.5 are the WPCP's existing liquids and solids flow schematics, respectively.

-This Page Intentionally Left Blank-



Figure 3.1 WPCP Site Map with Facility Pond Locations

-This Page Intentionally Left Blank-

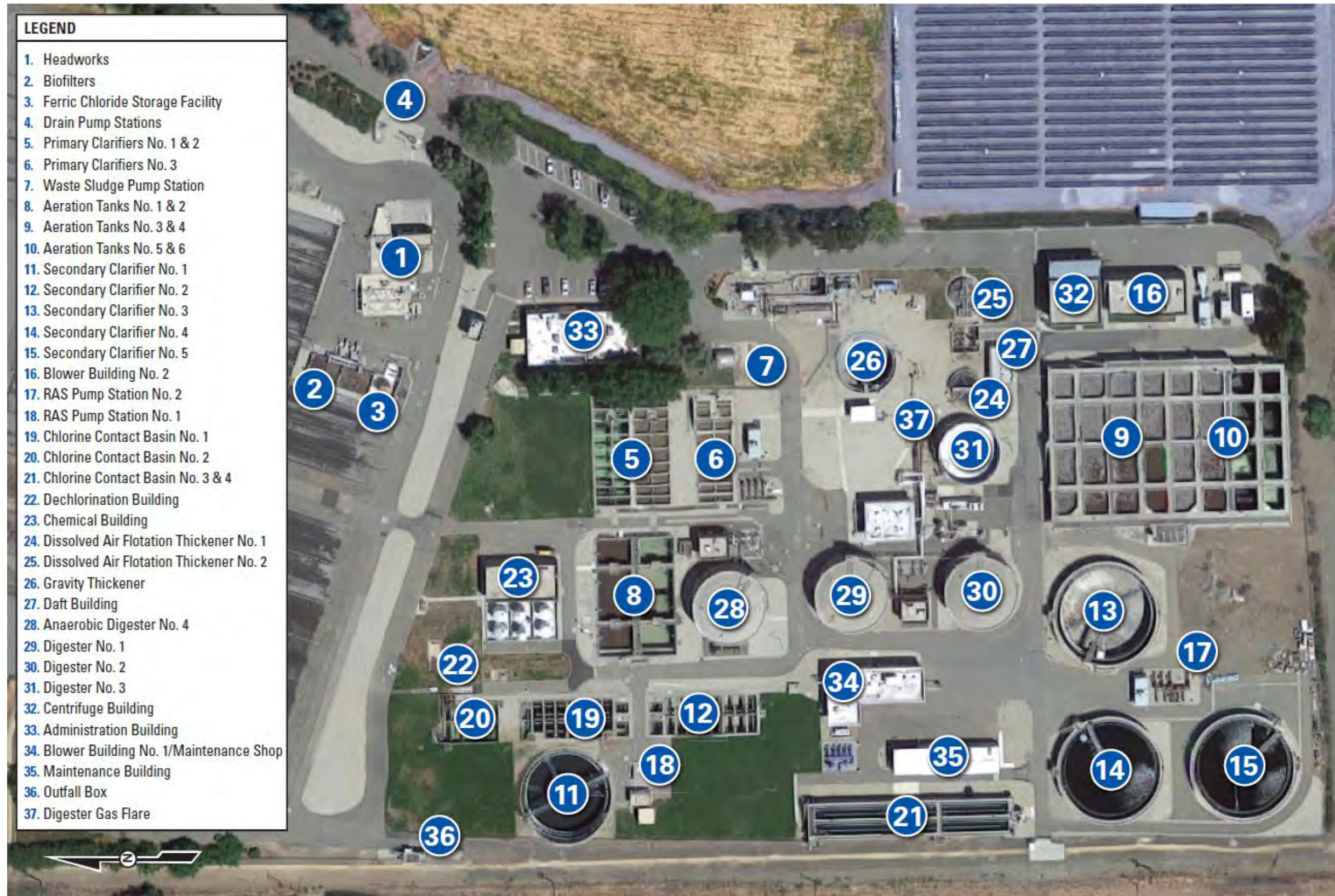

Figure 3.2 Existing WPCP Treatment Works and Facility Buildings

-This Page Intentionally Left Blank-

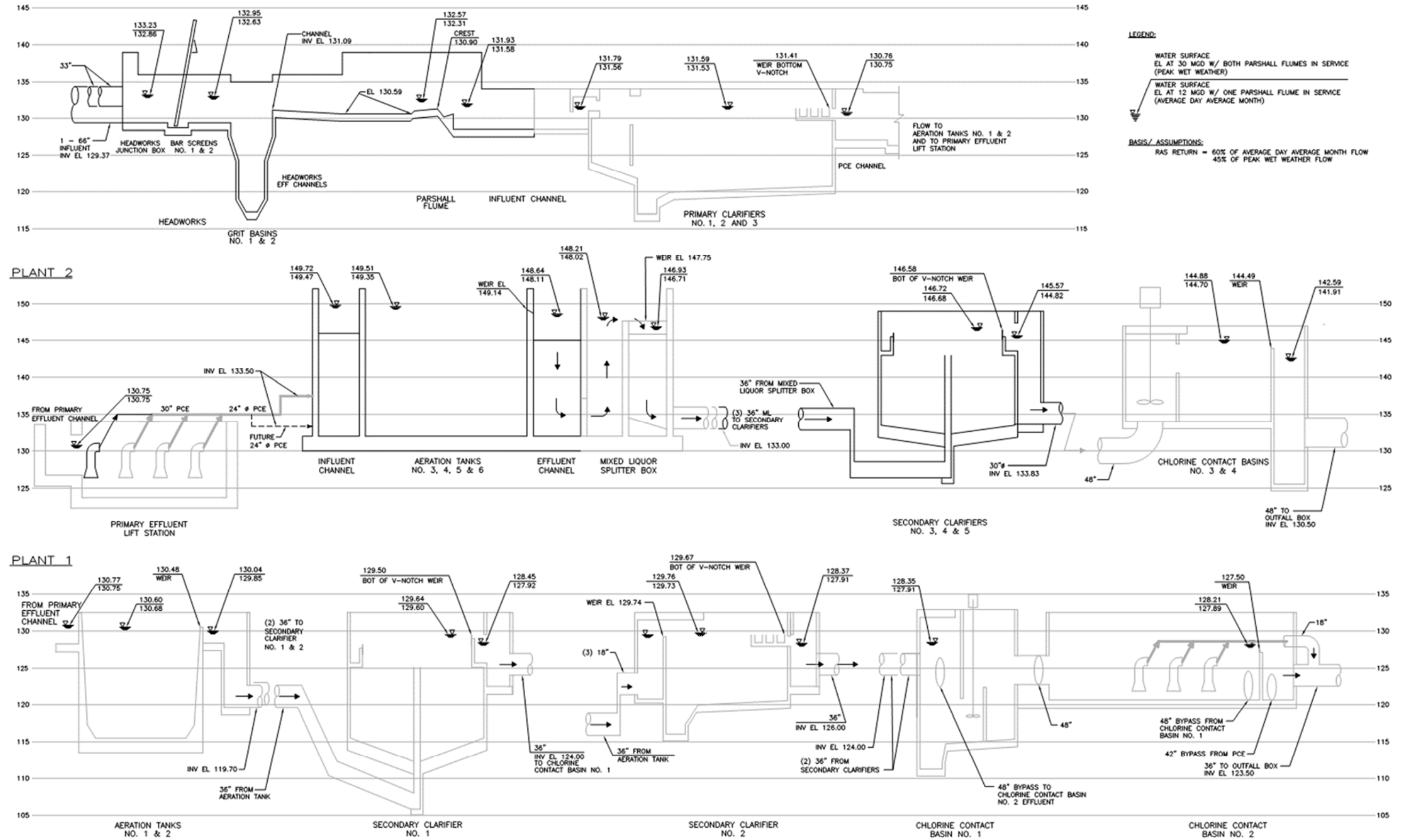

Figure 3.3 Existing WPCP Hydraulic Profile⁵

⁵ Water surface elevations are based on AA design flows of 12 mgd and design peak flows of 30 mgd.

-This Page Intentionally Left Blank-

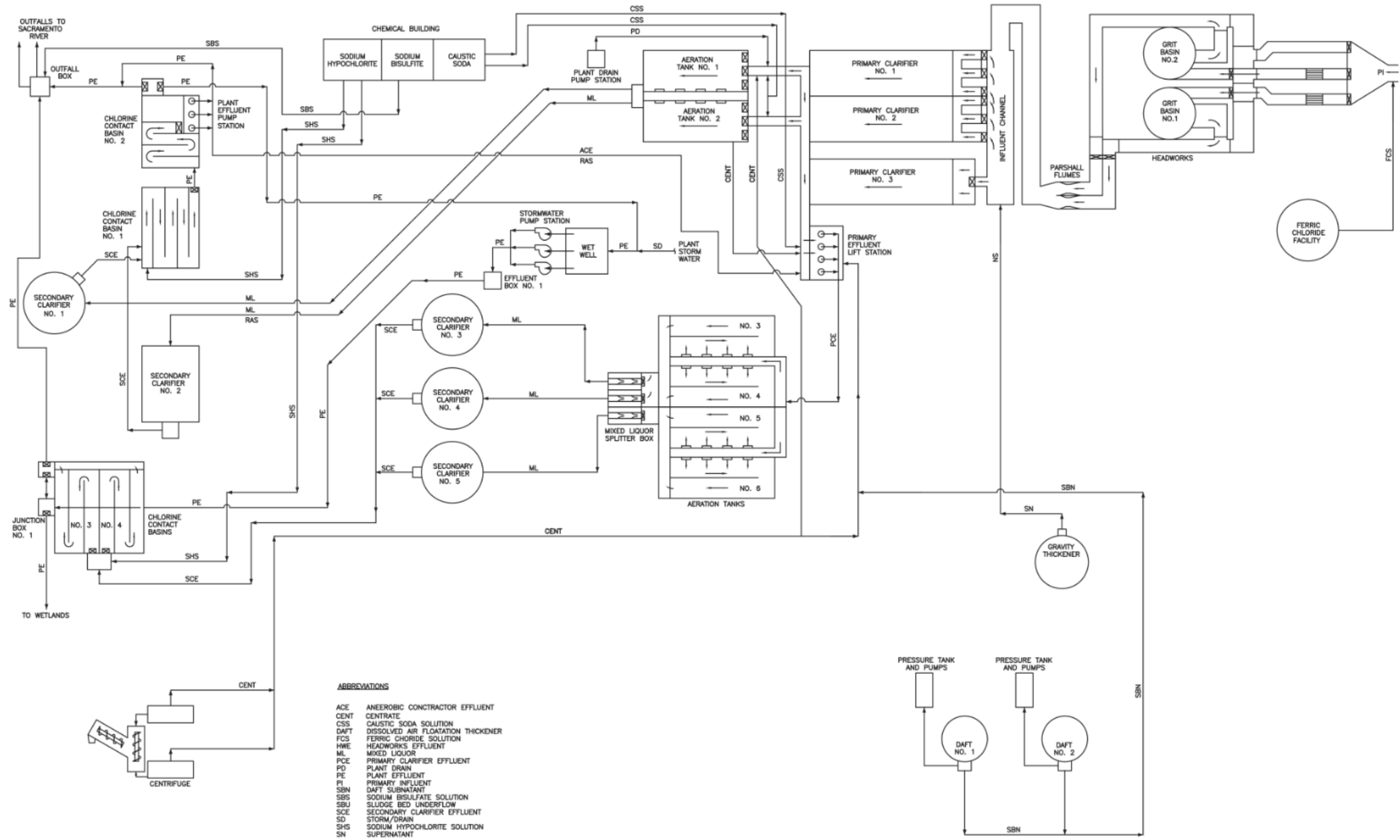

Figure 3.4 Existing Liquids Flow Schematic for WPCP

-This Page Intentionally Left Blank-

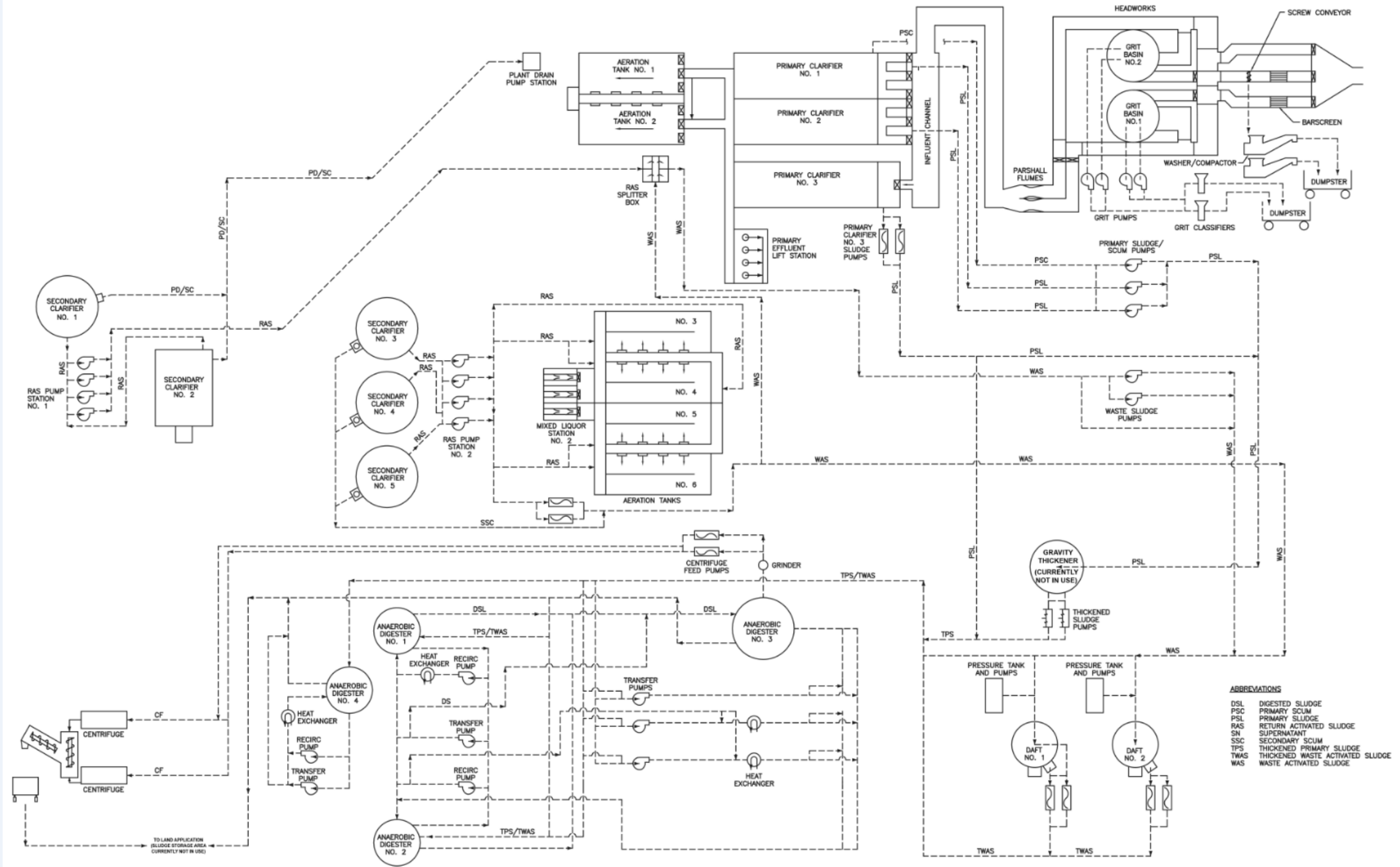

Figure 3.5 Existing Solids Flow Schematic for WPCP-This Page Intentionally Left Blank

-This Page Intentionally Left Blank-

3.3 Peak Hydraulic Capacity Evaluation

A detailed hydraulic model was prepared to develop the hydraulic capacity for individual unit processes, which was then evaluated against the projected peak flow of 39.6 mgd using the following unit process criteria:

- *Pumping processes* are evaluated based on their capacity for handling the peak flow condition with the largest unit out of service (firm capacity).
- *Hydraulic structures* are evaluated based on their capacity for handling the peak flow condition without over-topping the walls or submerging the effluent weirs.

The hydraulic capacity was evaluated assuming that only the Plant 2 secondary and disinfection facilities will be in operation during projected peak flows (per current operation).

3.3.1 Headworks

Untreated wastewater from the City's collection system enters the WPCP via 66-inch and 33-inch sewer pipes that connect to a junction box where flow is combined before flowing into the Headworks facility.

Upon entering the Headworks, the water flows through two of three bar screen channels and two mechanically induced vortex grit chambers. De-gritted influent flow is conveyed to the Parshall flume located to the southwest of the Headworks through two 4-foot-wide channels.

The Headworks facility was designed for 15 mgd buildout condition (which had an associated peak flow of 37.5 mgd when the facility was constructed); with two mechanical bar screens designed for a peak flow of 19 mgd each and two grit chambers designed for a peak flow of 20 mgd each.

To meet the projected peak flows, a third mechanical barscreen will be needed (replacing the manual bar rack that is currently installed in the third screen channel) by 2054.

3.3.2 Primary Treatment

From the Parshall flume, water flows through a 5-foot-wide rectangular concrete box channel that reduces to a 4-foot-wide rectangular channel before Primary Clarifier No. 1. The channel then reduces to a 3-foot-wide rectangular channel before Primary Clarifier No. 2, with channel width remaining at 3-feet for the rest of the influent channel.

Transition concrete channels split the flow from the influent channel to the three primary clarifiers. The effluent from the primary clarifiers is routed to the Primary Effluent Lift Station via a 4-foot-wide concrete channel. From this location, the flow is pumped to the Plant 2 secondary treatment train.

3.3.3 Primary Effluent Pumping

The Primary Effluent Lift Station contains four vertical turbine pumps, with three pumps rated at 6,600 gallons per minute (gpm) at 30 feet of head and the fourth pump rated at 6,800 gpm at 50 feet of head. This station has a current total capacity of 34.5 mgd and a firm capacity of 28.5 mgd for the pumps. The force main between the Primary Effluent Lift Station and the aeration tanks has a capacity of 24.0 mgd. The capacity of this station can be extended with the installation of a parallel force main between the Primary Effluent Lift Station and the aeration

tanks and with modifications to the existing Primary Effluent Lift Station to allow the installation of another pump.

With a firm capacity of 19,800 gpm (28.5 mgd) for the pumps and 24.0 mgd for the force main, the Primary Effluent Lift station has sufficient hydraulic capacity for the projected AAF flow of 17.1 mgd, but not enough capacity for the projected peak hour wet weather flow of 39.6 mgd.

To meet peak flow projections summarized herein, the parallel force main will be needed by 2038 and an additional pump will be needed at the Primary Effluent Pump Station by 2054.

3.3.4 Secondary Treatment and Disinfection

The Primary Effluent Lift Station pumps primary effluent to the influent channel of Aeration Tank Nos. 3, 4, 5, and 6. Return activated sludge (RAS) can be mixed with the primary effluent at this point or added directly to each aeration tank. Mixed liquor exiting from the four aeration tanks enters the Mixed Liquor Splitter Box where the flow is currently split into three streams. The flows are transported to Secondary Clarifier Nos. 3, 4, and 5 through three 36-inch pipes. Effluent from the three secondary clarifiers is combined in two 36-inch pipes that combine into a 48-inch pipe before it enters Chlorine Contact Basin Nos. 3 and 4. After passing through the flash mixer, the flow is split between the two chlorine contact basins. Effluent from both chlorine contact basins is combined and flows to the Outfall Box through a 48-inch pipe. At the Outfall Box, effluent is dechlorinated, and then flows toward the river through parallel 48-inch and 33-inch pipelines.

3.3.5 Peak Hydraulic Capacity Analysis Summary

The existing system provides hydraulic control points at each of the major processes, including the primary clarifiers, aeration tanks, secondary clarifiers, and the chlorine contact basins. The control points, in the form of rectangular or v-notch weirs, provide hydraulic breaks between the processes. These hydraulic breaks are needed so that flows are split evenly between process units where required, and so that the processes are operated within design parameters in a manner such that process performance can be maintained.

The submerged flow condition for each of the WPCP main hydraulic breaks is summarized in Table 3.3 along with the results of their associated adequacy evaluation. Since the weirs are at a lower elevation than the top of the structure, the submerged weir condition is the criteria used for peak flow capacity.

Table 3.3 Hydraulic Capacity Summary for WPCP Major Processes

Unit Process	Submerged Effluent Weir Flow Condition (mgd)	Adequate Peak Hydraulic Capacity? ⁽¹⁾
Primary Clarifiers	29	No
Aeration Tanks	33	No
Secondary Clarifiers	33	No
Chlorine Contact Basins	25	No

Notes:

(1) Compared against peak flow projection of 39.6 mgd.

Facility improvements necessary to meet hydraulic capacity needs within the planning period are discussed in Section 3.4 in context of process needs for the same facilities.

3.4 Treatment Process Capacity Evaluation

Existing plant treatment processes were modeled using BioWin™, with projected flow and load conditions and more stringent effluent limitations outlined in Chapter 5. The model was calibrated using AA flow and load data from 2020.

The process capacity was evaluated assuming that only Plant 2 secondary and disinfection facilities will be in operation during projected peak flow and loading conditions (per current operation).

Process capacity scenarios modeled for this evaluation are summarized in Table 3.4.

Table 3.4 Modeling Scenarios

Treatment Objective ⁽¹⁾	Process	Current Flows and Loads	Projected Flows and Loads
Current Operation	Nitrifying Activated Sludge with Partial Denitrification	Modeled	Modeled
Reduction of effluent nitrate ⁽²⁾	MLE (Modified-Ludzack Ettinger)	Not Modeled	Modeled
Reduction of effluent TSS/BOD ⁽³⁾	MLE + Filtration	Not Modeled	Modeled
Reduction of inorganics and disinfection byproducts ⁽⁴⁾	MLE + Filtration + Advanced Disinfection	Not Modeled	Modeled

Notes:

(1) Based on projected regulatory requirements summarized in Chapter 5.

(2) Less than 10 mg/L NO₃ + NO₂.

(3) 10/15/30 mg/L (average monthly, average weekly, and maximum daily).

(4) Values currently undefined but would predicate non-chlorine disinfection.

3.4.1 Primary Treatment Facilities

Primary treatment facilities at the plant remove the portion of the influent suspended solids that can be separated from the flow by gravity. These facilities also remove grease, scum, and floatables from the influent. The principal components at the WPCP for the primary treatment process are the primary clarifiers and the primary sludge and scum pumping systems.

3.4.1.1 Primary Clarifiers

Three primary clarifiers are currently in use at the Chico WPCP. All are rectangular in shape and measure 98 feet by 38 feet, with a sidewater depth of 10.3 feet. To maintain acceptable overflow rates through 2057, a fourth primary clarifier would need to be constructed by 2044. The design overflow rate for all clarifiers in service with this additional unit would be 1,150 gallons per day per square foot (gpd/ft²) for projected AA flow and 2,660 gpd/ft² for peak flow. The firm overflow rates for AA and peak flows are 1,530 gpd/ft² and 3,540 gpd/ft², respectively. These overflow rates fall within commonly accepted design criteria.

3.4.1.2 Primary Sludge and Scum Pumping

Primary sludge is thickened in Primary Clarifier Nos. 1 and 2 and pumped by three primary sludge double disc pumps to the digesters, each with a capacity of 200 gpm. Two primary sludge progressive cavity pumps are dedicated to Primary Clarifier No. 3, each with a capacity of 70 gpm at 60 feet of head.

These systems continue to provide sufficient capacity for current loads and treatment objectives as well as projected loads and advanced treatment.

3.4.1.3 Summary of Primary Treatment System Needs

The Headworks facility will need a third mechanical barscreen by 2054.

The primary treatment facilities will require an additional primary clarifier by 2044 and a capacity expansion for the Primary Effluent Lift Station which includes a parallel force main by 2038 and an additional primary effluent pump (with related wet well improvements) by 2054.

3.4.2 Secondary Treatment Facilities

The capacity evaluation presented herein discusses operation of the secondary treatment unit processes in nitrification mode. Nitrification describes the biochemical process whereby NH_3 present in municipal wastewater is oxidized into nitrate. Currently, the WPCP nitrifies the wastewater through a single stage nitrification step, where the nitrification process occurs simultaneously with carbonaceous treatment. Carbonaceous treatment is the oxidation of soluble and particulate organic compounds present in the primary effluent by biochemical processes, which is the primary focus of secondary treatment. Since the front of the aeration tanks is unaerated, partial denitrification is achieved from the nitrate in the RAS returned to these unaerated zones.

3.4.2.1 Aeration Tanks and Secondary Clarifiers

Aeration Tank Nos. 3 through 6 are rectangular and each have a total volume of approximately 4.36 million gallons (MG).

Secondary Clarifier Nos. 3, 4 and 5 are all 100-foot diameter circular tanks with a sidewater depth of 14 feet. Each clarifier has a center pier-mounted rotating sludge collector mechanism driven by a 1 horsepower (hp) motor.

3.4.2.2 Existing Nitrifying Activated Sludge Process

With all 4 existing aeration tanks and all three existing secondary clarifiers in service, the WPCP does not have adequate capacity to treat the projected max month BOD, TSS, and NH_3 loads at the projected peak flows.

Using the projected influent TSS loads developed in Chapter 2 and assuming a sludge volume index (SVI) of 120 mL/g, the existing Aeration Tank #6 may need to be in service by 2023, assuming MM loads occur concurrent to peak flows. The operation of this fourth aeration tank will dilute the mixed liquor concentration to ensure that the three existing secondary clarifiers can provide adequate treatment.

Impact of Sludge Retention Time on Facility Needs

The City currently sees significant energy savings by operating the aeration tanks under suboxic conditions (i.e. dissolved oxygen ranging from 0.5 to 1 mg/L). The process has been optimized to operate under these conditions at an 11-day solids retention time (SRT) with the SRT and DON Master, which control aeration and wasting for the secondary process.

With all four existing aeration tanks and all three existing secondary clarifiers in service, assuming no change to the current SRT of 11 days in the near-term, the need for a new (fourth) secondary clarifier is projected by 2028. Reducing the SRT to 9 days shifts this need for a new fourth secondary clarifier back 2 years to 2030.

While a 9-day SRT is sufficient for meeting effluent ammonia targets, it's not certain if the same level of nutrient reduction can be achieved as with an 11-day SRT. Since maintaining an 11-day SRT will require more aeration tanks and secondary clarifiers at buildout (2057) than a 9-day SRT would require for the same level of treatment, the City is open to operation with a 9-day SRT in the future. Thus, alternatives evaluated for improving the secondary treatment process long-term use an SRT of 9 days, while near-term needs are evaluated based on the current SRT of 11 days. Options for secondary system upgrades to meet the projected flows and loads at an SRT of 9 day are discussed in more detail in Chapter 4. In short, the WPCP will need 2-4 new secondary clarifiers and 2-3 new aeration tanks, depending on selected configuration. Refer to Table 3.5 for the estimated timeline that each structure will be needed.

Impact of Sludge Volume Index on Facility Needs

The timeline for required upgrades may shift if there is a significant increase in the plant's SVI, which could occur after transitioning to the Modified Ludzack-Ettinger (MLE) process by 2032 (discussed herein and in Chapter 5). Although the WPCP has consistently produced sludge with SVIs below 120 mL/g, transitioning an activated sludge process to the MLE process can sometimes result in poorer settling and higher SVIs. Observations conducted subsequent to that transition to MLE will better define the timing for more clarifier upgrades needed within the planning period.

Under projected peak flows, the secondary clarifiers would collectively have a total surface overflow rate between 720 gpd/ft² (assuming 7 total secondary clarifiers) and 1,110 gpd/ft² (assuming 5 total secondary clarifiers), depending on the configuration at buildout as discussed in Chapter 4. These surface overflow rates fall within commonly accepted design criteria⁶. The solids loading for both configurations was also confirmed to be within acceptable operating ranges using a state point analysis.

3.4.2.3 Regulatory-Driven Capacity Impacts

To meet the future anticipated total nitrogen (combined nitrate and nitrite) effluent limit of <10 mg/L, it is recommended that the aeration tanks be reconfigured for the MLE process. MLE is a very common nitrogen removal process. With this process, removal of NH₃ occurs with similar operation as that currently used at the WPCP (long [7+ day] SRT and additional aeration to facilitate nitrification in the aerobic portions of the aeration tanks), but includes an anoxic zone to induce denitrification.

⁶ Maximum recommended surface overflow rate at peak flow is 1,200 gpd/ft² (Ten-States Standards).

As mentioned previously, some nitrate removal is already being achieved through introduction of the RAS in the unaerated zones at the front of the aeration basins. To facilitate more nitrate removal, mixed liquor recycle (MLR) pumps will be added to increase the amount of nitrate returned to the unaerated zones at the front of the aeration tanks. With the current 2-pass wrap-around configuration, MLR pumping could be added in the common wall at the east end of the tanks, providing a relatively low-cost nutrient removal upgrade.

At a MLR ratio of 300 percent (3 times the influent flow to each tank is recycled back to the anoxic zones), upgraded Aeration Tank Nos. 3 through 6 can produce effluent with approximately 15 mg/L combined nitrate and nitrite at current demands. MLR rates above 300 percent provide diminishing returns in terms of nitrate removal.

Based on the process model (calibrated using the last full year of operational data from 2020) there is not enough soluble BOD (the carbon source for the bacteria) in the primary effluent to support denitrification to treatment levels below 10 mg/L. To increase the soluble BOD and improve the denitrification capacity, a range of options are available:

- Increasing the MLR rate improves nitrate removal but very minimally.
- Increasing the anoxic volume to 50 percent of the total tanks volume, which can be accomplished with the addition of baffle walls, can achieve the required reduction but comes at the expense of reduced aerobic volume (necessary for BOD and NH₃ removal) which decreases the ability of the system to adequately treat any significant short-term change of influent characteristics.
- Adding chemical "food" addition (e.g., methanol or acetate) directly to the process. This approach is typically a last resort (due to high capital and operational costs), but it is the best option in this case since it will minimize the number of aeration tanks that will be needed in the future.

A detailed wastewater characterization and refined plant process model (using dynamic analysis) is recommended during design of the secondary treatment expansion processes to confirm sizing for the required methanol feed facility.

3.4.2.4 Aeration Capacity

Three high-speed turbo blowers currently supply the aeration system air at the WPCP. One blower has a nameplate capacity of 4,500 standard cubic feet per minute (scfm) at a pressure of 9.1 pounds per square inch gauge (psig), and the other two blowers are dual core and each have a nameplate capacity of 7,800 scfm (3,900 scfm per core) at 9.5 psig. Air requirements in nitrifying activated sludge mode (current operation) at projected AA and MM loads are estimated to range from 13,700 to 14,600 scfm, and 18,300 to 19,500 scfm, respectively, depending on the treatment plant configuration and operation at buildout.

The existing system has a firm capacity of 15,600 scfm, with a blower nameplate capacity of 20,100 scfm, and is sufficient for projected AA loads but not for MM loads. Additionally, actual performance of the dual core blowers has not yet been established relative to the rated capacity and the remaining blower did not match the rated capacity.

Additional aeration capacity will be needed for the modified build-out condition.

3.4.2.5 Plant 2 RAS and WAS Pumping

RAS Pump Station No. 2 consists of four horizontal mixed-flow centrifugal pumps, each with a capacity of 2,100 gpm at 24 feet of head. A RAS pump is dedicated to each of the three secondary clarifiers, and a fourth pump is configured for standby use by any of the clarifiers. A total of 9 mgd firm RAS pumping capacity is provided by RAS Pump Station No. 2.

The waste activated sludge (WAS) pumps are also located at the RAS Pump Station No. 2. The WAS pumps consist of two progressive cavity pumps, each with a capacity of 150 gpm at 35 feet of head.

These systems will not provide sufficient firm capacity for projected loads and treatment objectives. At least 4 additional RAS pumps and 1 additional WAS pump will be required to provide firm capacity for projected RAS and WAS flows at the projected MM flows and loads; however, it is most likely that 1 additional RAS pump will be provided for each new secondary clarifier that is built and that 1 additional WAS pump will be provided for every 2 new secondary clarifiers that are built, which would also provide sufficient capacity.

3.4.2.6 Summary of Secondary Treatment System Needs

The secondary treatment facilities will require significant improvements to adequately treat the projected flows and loads through 2057. This includes a new secondary clarifier by 2028, and up to three more secondary clarifiers and three more aeration tanks by 2057. Additional blowers and RAS/WAS pumps will also be needed to support the new aeration tanks and clarifiers, plus ancillary facilities.

To address regulatory requirements, MLE upgrades and a supplemental carbon facility will be needed by 2032.

3.4.3 Disinfection

The existing plant effluent disinfection system uses liquid sodium hypochlorite solution (SHS) to disinfect the secondary effluent, and liquid sodium bisulfite solution (SBS) to dechlorinate the disinfected effluent prior to discharge.

3.4.3.1 Sodium Hypochlorite Feed System

SHS is stored in two 9,500-gallon storage tanks located at the Chemical Building. The Chemical Building contains four metering pumps for distribution of SHS throughout the plant; two that are rated at 150 gallons per hour (gph) and two that are rated at 60 gph. The 150 gph pumps deliver SHS for chlorination of the effluent at Chlorine Contact Basin Nos. 3 and 4, and the 60 gph pumps deliver SHS to the other dosing points within the plant (with duty/standby configuration for both pumping systems).

The SHS feed system does not have enough storage and pumping capacity to meet the plant demands at projected AA and peak flows and it is recommended additional SHS pumps and storage be installed at the same time the new CCB described below is constructed.

3.4.3.2 Disinfection Contact Facilities

Chlorine Contact Basin Nos. 3 and 4 each have a volume of 257,000 gallons. In normal operation, the basins are operated in parallel. Each of the basins can be taken out of service for cleaning and other maintenance purposes.

The existing facilities are not sufficient to provide a 30-minute hydraulic residence time (HRT) at the projected peak flow of 39.6 mgd nor are they sufficient to provide a 60-minute chlorine contact (CT) time at the projected AA flow of 17.1 mgd. An additional CCB, equal in size to the two existing CCBs will be required by 2033 to provide a sufficient HRT and a sufficient CT time for the projected flows.

3.4.3.3 Dechlorination Facilities

The SBS feed system consists of two 6,500-gallon liquid SBS storage tanks, two 80 gph metering pumps, two chlorine residual analyzers, and ancillary equipment.

The Outfall Box gates are hydraulically actuated and are connected to the plant SCADA system to allow flow to the river to be interrupted upon detection of a positive chlorine residual. The gate controlling pond discharge is also integrated within the hydraulic controls, allowing for automated diversion. Modification of the Outfall Box will be needed to meet the projected peak flow condition.

The SBS feed system does not have enough storage and pumping capacity to meet the plant demands at projected AA and peak flows and it is recommended additional SBS pumps and storage be installed at the same time the new CCB described above is constructed.

3.4.3.4 Summary of Disinfection and Dechlorination Facility Needs

The existing chlorine contact basins are not adequately sized for projected AA and peak flows, and the existing chlorination and dechlorination chemical storage and delivery facilities are also not adequately sized for the projected flows.

To provide adequate disinfection and dechlorination for peak flows through 2057, an expansion of the disinfection and dechlorination facilities will likely be needed by 2033. These include one additional chlorine contact basin, increased SHS and SBS storage and pumping capacity, and modification of the Outfall Box.

As discussed in Chapter 5, it is anticipated that the City will be required to implement alternate disinfection (non-chlorination) by 2047. The City may consider expedited implementation of the alternate disinfection facilities to avoid sunk costs associated with construction of the needed disinfection system upgrade in 2033.

3.4.4 Solids Handling

Existing on-site solids handling systems at the plant are evaluated in the following subsections.

3.4.4.1 Primary Solids Thickening

Solids removed from the primary clarifiers were previously thickened in a single 55-foot diameter gravity thickener converted from a primary clarifier. The generous sizing was because this tank was initially used as a primary clarifier and then used as a thickener for both primary and secondary sludge. This practice was discontinued when the first dissolved air flotation thickener (DAFT) was constructed to separately thicken WAS.

The recent conversion of the Primary Clarifier No. 1 and 2 sludge pumps to positive displacement, double disc diaphragm pumps has allowed WPCP staff to experiment with sludge thickening directly in all of the primary clarifiers. Previously this capability was only possible in Primary Clarifier No. 3. To date the WPCP has had positive results with this change and the gravity thickener process is currently not in use.

3.4.4.2 WAS Thickening

WAS is presently thickened separately from primary sludge prior to stabilization in the anaerobic digesters. Dual 25-foot diameter dissolved air flotation thickeners (DAFTs) are provided for this purpose. Operation of the two existing DAFTs provides sufficient capacity to thicken WAS at the projected MM flows of 21.7 mgd. In the event that one DAFT is out of service, the remaining unit could be operated at a level exceeding its design capacity.

WAS pumping can be interrupted for short term periods since it is not critical to waste secondary solids continuously so long as the appropriate waste volume is maintained over time. The presence of a second unit provides additional reliability for the WAS thickening process. One unit may be out of service for maintenance reasons without adversely affecting the process and can accommodate longer shutdown periods, if required.

The existing system provides adequate capacity for the projected AA and MM loads.

3.4.4.3 Anaerobic Digestion

Solids generated from the primary sedimentation and secondary treatment processes are stabilized in three 70-foot diameter anaerobic digesters (Anaerobic Digester Nos. 1, 2, and 4) having a combined volume of 277,500 cubic feet (2,077,500 gallons). The sludge is heated for Anaerobic Digester Nos. 1, 2, with pumped circulation of the digester contents through external heat exchangers. Externally mounted pumps provide mixing within the digesters.

The floating cover digester was converted to Anaerobic Digester No. 3 and serves primarily as a sludge storage/holding tank for the solids dewatering process. This tank is a 60-foot diameter tank with a total effective storage of 32,500 cubic feet (243,000 gallons). This volume provides approximately 1.5 days sludge storage at a plant influent flow rate of 17.1 mgd. Anaerobic Digester No. 3 could also be heated and used as a primary digester if Digester No. 1, 2, or 4 is out of service. Anaerobic Digester No. 3 has a gas mixing system and recirculation pump discharge nozzles to keep the contents of the digester mixed before the dewatering process.

At the projected sludge generation rate, Anaerobic Digester Nos. 1, 2, and 4 are capable of providing a theoretical detention time of about 15.4 days under MM loading conditions. A minimum detention time of 15 days at MM loadings is required for the solids to meet federal EPA requirements as a Process to Significantly Reduce Pathogens (PSRP). Compliance with the PSRP requirements is essential to provide the City with the stabilization needed for the biosolids to be classified as Class B, as required for land application.

The existing system provides adequate capacity for the projected AA and MM loads.

3.4.4.4 Solids Dewatering

Two separate methods of solids dewatering are available at the WPCP. Digested sludge from Anaerobic Digester No. 3 can be fed to the centrifuge for solids dewatering. The centrifuge mechanically dewateres the digested sludge through high-speed rotation, concentrating the solids into a "cake." The centrifuge utilizes polymer to flocculate the solids prior to dewatering. Following centrifuge dewatering, the solids can either be directly off-hauled, or stored on site for future disposal. The WPCP currently dewateres all solids via centrifuge and has them off-hauled directly through a contract with Synagro.

Alternatively, digested sludge may be directly transferred to the drying beds located to the north of the WPCP unit processes. These drying beds may be also used for further drying of the cake

solids from the centrifuge, or digested sludge can be transferred to the beds directly from the digesters. After completion of solar drying, the solids can be stockpiled in two designated areas to await off haul.

The existing centrifuges were designed to dewater digested sludge from the sludge storage tank (Anaerobic Digester No. 3) for 45 hours per week at 18 mgd MM design conditions. However, even at an MM flow of 21.7 mgd, the centrifuge firm capacity will likely be sufficient to keep the centrifuge run time below 31 hours per week. Under this operational strategy and at a projected MM flow of 21.7 mgd in 2057, the solids dewatering process has adequate capacity.

3.4.4.5 Digester Gas

Digester gas is a usable byproduct produced continually by the anaerobic digesters. Digester gas is utilized in two areas: the boilers of the integrated-type sludge heaters and the cogeneration system. The demand for gas by the boilers and cogeneration system is intermittent and variable.

There are presently no facilities at the plant intended for the storage of gas produced by the anaerobic digestion process. A very limited amount of storage is available in the space between the digester domes on the fixed-roof digesters and the surface of the digester contents. Once this space is filled and the gas demand is satisfied, excess gas is flared in the waste gas burner. The cogeneration feasibility study determined that digester gas storage did not provide an economic benefit to operate in a peak shaving mode. This analysis is not repeated herein.

3.4.4.6 Summary of Solids Handling Facility Needs

The solids handling facilities have adequate capacity to support project flows and loads discussed herein.

3.5 Summary of WPCP Capacity Limitations

The WPCP does not have the capacity for adequate treatment of the currently projected flows and loads through the planning period ending in 2057.

A summary of capacity-driven facility needs is included in Table 3.5, including the estimated timeline for implementation of each improvement.

Table 3.5 Summary of Capacity-Driven Facility Needs

Improvement	Required Timeline ⁽¹⁾
Fourth Secondary Clarifier	2028 ⁽²⁾
Supplemental Carbon Project ⁽³⁾	2032
Chlorine Contact Basin ⁽⁴⁾	2033 ⁽⁵⁾
Fifth Secondary Clarifier ⁽⁶⁾	2036 ⁽⁷⁾
Primary Effluent Parallel Force Main	2038
Sixth Secondary Clarifier ⁽⁶⁾	2039 ⁽⁷⁾
Fifth Aeration Tank ⁽⁸⁾	2044 ⁽⁷⁾
Primary Clarifier # 4	2044
Sixth Aeration Tank ⁽⁸⁾	2053 ⁽⁷⁾
Primary Effluent Pump Station Improvements	2054
Mechanical Barscreen	2054

Notes:

- (1) Based on projected flows and loads summarized in Chapter 2 and existing process limitations discussed in this chapter.
- (2) Assumes current 11-day SRT is maintained.
- (3) Associated with the regulatory-driven MLE project.
- (4) Plus ancillary facilities (SBS and SHS storage and pumping, Outfall Box modifications, and associated structural/civil/electrical/instrumentation improvements).
- (5) City may consider implementation of alternate disinfection in lieu of additional chlorine contact facility construction.
- (6) Plus ancillary facilities (RAS/WAS pumping and associated structural/civil/electrical/instrumentation improvements) and southern pond improvements necessary for secondary expansion in that area.
- (7) Assumes SRT of 9-days and a planned facility layout that includes 1 new (100-ft diameter) secondary clarifier, 2 new (125-ft diameter) secondary clarifiers, and 2 new aeration tanks. Additional expansion options are presented in Chapter 4.
- (8) Plus ancillary facilities (blower and electrical building and associated upgrades, ancillary structural/civil/electrical/instrumentation improvements, and a standby generator).

-This Page Intentionally Left Blank-

Chapter 4

CAPACITY-DRIVEN FACILITY NEEDS

Expansion alternatives for the WPCP are evaluated herein to achieve interim and final capacity needed for the facility given updated flow and load projections presented in Chapter 2 and identified capacity limitations identified in Chapter 3.

4.1 Approach

Processes and areas that will require capacity expansion and/or upgrade were identified in Chapter 3. Recommended improvements are discussed by WPCP area herein, with a summary of probable implementation schedule and conceptual level project cost estimates for each improvement.

4.2 Headworks

A third mechanical barscreen will be required by 2054 to adequately handle the projected peak flows. The following improvements are needed as part of the barscreen project:

- Demolition of existing manual bar rack.
- Installation of new mechanical barscreen.
- Extension of existing screenings conveyor¹.
- Ancillary structural, electrical, and instrumentation improvements.

The estimated costs for the new bar screen are \$500,000 (construction cost) and \$600,000² (project cost), both in December 2021 dollars. This cost is carried through in Chapter 1 and 7 summary tables with forecasted implementation by 2054.

4.3 Primary Clarification

A fourth primary clarifier will need to be constructed by 2044 to maintain acceptable overflow rates in the primary clarifiers (Figure 4.1).

The existing primary sludge and scum pumping systems provide sufficient capacity for the projected loads and advanced treatment but will need to be reconfigured for use with the new primary clarifier.

¹ Assumes that screenings conveyor is still in appropriate condition for extension. May require conveyor replacement.

² Project cost factor reduced to 15% due to project simplicity.

-This Page Intentionally Left Blank-



Figure 4.1 Primary Clarifier #4

-This Page Intentionally Left Blank-

The following improvements are needed as part of the primary clarifier project:

- Primary clarifier.
- Reconfiguration of existing sludge and scum pumping systems³.
- Ancillary civil, structural, electrical, and instrumentation improvements.

The estimated costs for the primary clarifier project are \$3.7 million (construction cost) and \$5.0 million (project cost), both in December 2021 dollars. This cost is carried through in Chapter 1 and 7 summary tables with forecasted implementation by 2044.

4.4 Primary Effluent Pumping

Primary Effluent Lift Stations improvements will be required by 2038 to increase the hydraulic capacity of the system for anticipated peak flows. The following improvements are needed to upgrade the Primary Effluent Lift Station project for the build-out flows:

- Parallel force main between the primary effluent lift station and the Plant 2 aeration tanks (by 2038).
- Primary Effluent Lift Station improvements (by 2054):
 - Wet well expansion.
 - Additional primary effluent pump.
 - Ancillary mechanical, electrical, and instrumentation improvements.

The estimated construction costs for the improvements associated with the Primary Effluent Parallel Force Main and Lift Station Improvement Projects are \$800K and \$1.7 million, respectively, with estimated project costs totaling \$1.1 million and \$2.1 million, respectively.

All costs (all in December 2021 dollars) are carried through in Chapter 1 and 7 summary tables with forecasted need as discussed above.

4.5 Secondary Treatment Facilities

The secondary treatment facilities will require significant improvements to provide adequate treatment through 2057. Near- and long-term improvement recommendations are summarized in Table 4.1 and individual secondary treatment process components are discussed herein.

³ Existing pumping systems will likely have been replaced before the project is needed. The City should consider the future primary clarifier when/if pumping system adjustments are made.

Table 4.1 Secondary Treatment Facility Improvements

Existing WPCP (2022)	Near-Term Improvements (<2030)	Long-Term Improvements (<2057)
		MLE Upgrades
		Supplemental Carbon
4 Total Aeration Tanks		2 New Aeration Tanks (6 total)
3 Total Secondary Clarifiers	1 New Secondary Clarifier (4 total)	3 New Secondary Clarifiers (6 total) ⁽¹⁾
		Blower Upgrades
	RAS/WAS Pumping Upgrades	RAS/WAS Pumping Upgrades

Notes:

(1) Based on Secondary Treatment Expansion Option 3 presented herein. Includes one secondary clarifier matching existing unit sizing (100-ft diameter) and two larger (125-ft diameter) clarifiers.

4.5.1 Near-Term Improvements

An additional secondary clarifier will be needed by 2028 at the current WPCP operation with 11-day SRT. The addition of a fourth secondary clarifier will increase the total volume of secondary clarifiers from 2.47 MG to 3.30 MG (Figure 4.2).



Figure 4.2 Fourth Secondary Clarifier

-This Page Intentionally Left Blank-

The following improvements are needed as part of the Secondary Clarifier project:

- 100-foot diameter Secondary Clarifier with 14-ft side water depth.
- Dedicated RAS and WAS pumps (installed at existing RAS/WAS pump station).
- Ancillary civil, structural, electrical, and instrumentation improvements.

The estimated costs for the improvements associated with the 2028 Secondary Treatment improvements is \$8.0 million (construction cost) and \$10.7 million (project cost), both in December 2021 dollars. This cost is carried through in Chapter 1 and 7 summary tables with a forecasted need for a fourth secondary clarifier by 2028.

4.5.2 Options for Secondary Treatment Expansion

To provide adequate secondary treatment capacity through 2057, new aeration tanks and secondary clarifiers will be needed, with quantities of each contingent on SRT operation (Chapter 3) and City preference for facility layout. Following discussion with City staff, a 9-day SRT was selected for long-term planning and three options were identified:

- **Option 1:** Two new aeration tanks (6 total) and 4 new secondary clarifiers (7 total).
- **Option 2:** Three new aeration tanks (7 total) and 2 new secondary clarifiers (5 total).
- **Option 3:** Two new aeration tanks (6 total) and 3 new secondary clarifiers (of differing sizes).

For all options, the aeration tanks (new and existing) will need to be modified with MLE and supplemental carbon upgrades (discussed in Chapters 3 and 5).

4.5.2.1 Option 1

A potential layout for Option 1 is included below as Figure 4.3.

-This Page Intentionally Left Blank-

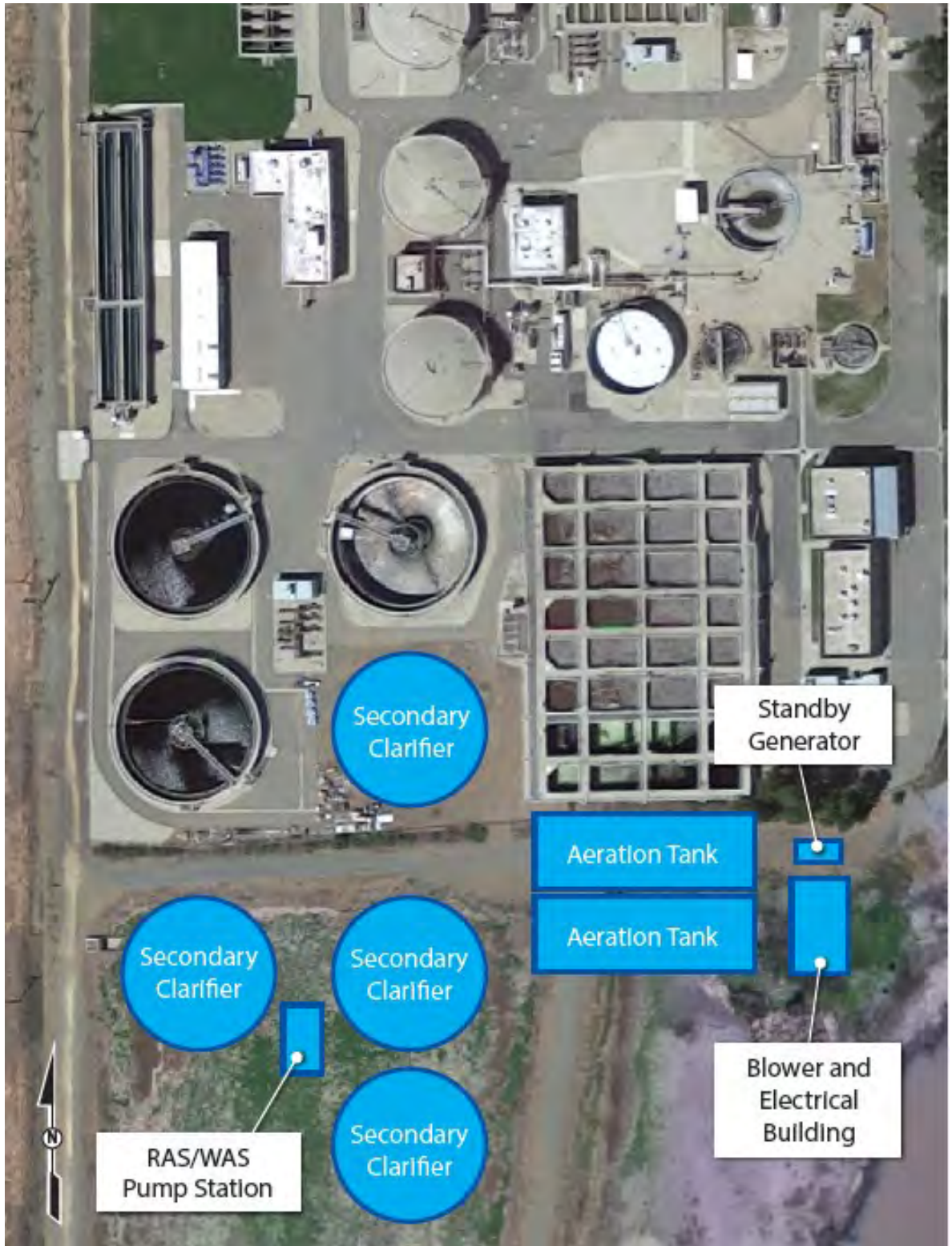

Figure 4.3 Secondary Expansion (Option 1)

-This Page Intentionally Left Blank-

Based on a long-term plan to adjust facility operation to meet a 9-day SRT, the following improvements will be needed for the Option 1 secondary expansion alternative:

- 2 new aeration tanks (rectangular, 2.2 MG each with MLE improvements).
- 3 additional secondary clarifiers (100 ft circular, 14 ft SWD).
- RAS/WAS pumping facilities (4 RAS and 2 WAS pumps).
- RAS/WAS electrical building.
- New Blower and electrical room (3 blowers).
- Standby generator.
- Ancillary civil, structural, electrical, and instrumentation improvements.

Project costs estimates were prepared for this option based on component costs developed to correspond with staged construction (i.e. as facilities are needed).

Refer to Table 4.2 for a summary of component costs associated with Option 1.

Table 4.2 Option 1 Component Costs

Treatment Unit	# Required	Component Project Cost	Total System Project Cost
Secondary Clarifier ⁽¹⁾	3 ⁽²⁾	\$10.7 M	\$32.1 M
Aeration Tank ⁽³⁾	2	\$14.5 M	\$29.0 M
MLE Upgrades ⁽⁴⁾	2	\$1.1 M	\$2.2 M
RAS/WAS Pump Station and Electrical Building ⁽⁵⁾	1	\$1.8 M	\$1.8 M
Blower and Electrical Room ⁽⁶⁾	1	\$6.3 M	\$6.3 M
Standby Generator	1	\$1.5 M	\$1.5 M
Southern Pond Improvements for Secondary Expansion	1	\$0.9M	\$0.9M
Estimated Project Cost⁽⁷⁾			\$73.8 M⁽⁸⁾

Notes:

- (1) 100-ft diameter with 14-ft side water depth.
- (2) Cost for 3 secondary clarifiers included here, with cost for the fourth clarifier discussed separately (as near-term improvement in Section 4.5.1).
- (3) 2.2 MG capacity matching layout of existing aeration tanks.
- (4) Cost presented as a ratio of the costs presented in Chapter 5 for existing basin retrofit.
- (5) Includes four (4) RAS pump and three (3) WAS pumps, with similar layout as existing RAS/WAS pump station facilities.
- (6) Includes three (3) blowers, with similar layout as existing blower building facilities.
- (7) In December 2021 dollars (ENR CCI 12482).
- (8) Actual project cost may differ if constructed as one project.

This option is expensive due to the number of structures required.

4.5.2.2 Option 2

A potential layout for Option 2 is included below as Figure 4.4.

-This Page Intentionally Left Blank-



Figure 4.4 Secondary Expansion (Option 2)

-This Page Intentionally Left Blank-

Based on a long-term plan to adjust facility operation to meet a 9-day SRT, the following improvements will be needed for the Option 2 secondary expansion alternative:

- 3 new aeration tanks (rectangular, 2.2 MG each with MLE improvements).
- 1 additional secondary clarifier (100 ft circular, 14 ft SWD).
- RAS/WAS pumping facilities (2 RAS and 2 WAS pumps).
- RAS/WAS electrical building.
- New Blower and electrical room (4 blowers).
- Standby generator.
- Ancillary civil, structural, electrical, and instrumentation improvements.

Project costs estimates were prepared for this option based on component costs developed to correspond with staged construction (i.e. as facilities are needed).

Refer to Table 4.3 for a summary of component costs associated with Option 2.

Table 4.3 Option 2 Component Costs

Treatment Unit	# Required	Component Project Cost	Total System Project Cost
Secondary Clarifier ⁽¹⁾	1 ⁽²⁾	\$10.7 M	\$10.7 M
Aeration Tank ⁽³⁾	3	\$14.5 M	\$43.5 M
MLE Upgrades ⁽⁴⁾	3	\$1.1 M	\$3.3 M
RAS/WAS Pump Station and Electrical Building ⁽⁵⁾	1	\$1.4 M	\$1.4 M
Blower and Electrical Room ⁽⁶⁾	1	\$7.2 M	\$7.2 M
Standby Generator	1	\$1.5 M	\$1.5 M
Southern Pond Improvements for Secondary Expansion	1	\$0.9M	\$0.9M
Estimated Project Cost⁽⁷⁾			\$68.5 M⁽⁸⁾

Notes:

- (1) 100-ft diameter with 14-ft side water depth.
- (2) Cost for 1 secondary clarifier included here, with cost for the fourth clarifier discussed separately (as near-term improvement in Section 4.5.1).
- (3) 2.2 MG capacity with MLE upgrades incorporated at time of construction.
- (4) Cost presented as a ratio of the costs presented in Chapter 5 for existing basin retrofit.
- (5) Includes two (2) RAS pump and two (2) WAS pumps, with similar layout as existing RAS/WAS pump station facilities.
- (6) Includes four (4) blowers, with similar layout as existing blower building facilities.
- (7) In December 2021 dollars (ENR CCI12482).
- (8) Actual project cost may differ if constructed as one project.

This option also presents a flow-split challenge that will be difficult to overcome and has high operational (and life cycle) costs compared to Option 1.

4.5.2.3 Option 3

A potential layout for Option 3 is included below as Figure 4.5.

-This Page Intentionally Left Blank-



Figure 4.5 Secondary Expansion (Option 3)

-This Page Intentionally Left Blank-

Based on a long-term plan to adjust facility operation to meet a 9-day SRT, the following improvements will be needed for the Option 3 secondary expansion alternative:

- 2 new aeration tanks (rectangular, 2.2 MG each with MLE improvements).
- 2 additional secondary clarifiers (125 ft circular, 14 ft SWD).
- RAS/WAS pumping facilities (3 RAS and 2 WAS pumps).
- RAS/WAS electrical building.
- New Blower and electrical room (3 blowers).
- Standby generator.
- Ancillary civil, structural, electrical, and instrumentation improvements.

Project costs estimates were prepared for this option based on component costs developed to correspond with staged construction (i.e. as facilities are needed).

Refer to Table 4.4 for a summary of component costs associated with Option 3.

Table 4.4 Option 3 Component Costs

Treatment Unit	# Required	Component Project Cost	Total System Project Cost
Secondary Clarifier ⁽¹⁾	2 ⁽²⁾	\$13.4 M	\$26.8 M
Aeration Tank ⁽³⁾	2	\$14.5 M	\$29.0 M
MLE Upgrades ⁽⁴⁾	2	\$1.1 M	\$2.2 M
RAS/WAS Pump Station and Electrical Building ⁽⁵⁾	1	\$1.6 M	\$1.6 M
Blower and Electrical Room ⁽⁶⁾	1	\$6.3 M	\$6.3 M
Standby Generator	1	\$1.5 M	\$1.5 M
Southern Pond Improvements for Secondary Expansion	1	\$0.9M	\$0.9M
Estimated Project Cost⁽⁷⁾			\$68.3 M⁽⁸⁾

Notes:

- (1) 125-ft diameter each with 14-ft side water depth.
- (2) Cost for 2 secondary clarifiers included here, with cost for the fourth clarifier discussed separately (as near-term improvement in Section 4.5.1).
- (3) 2.2 MG capacity with MLE upgrades incorporated at time of construction.
- (4) Cost presented as a ratio of the costs presented in Chapter 5 for existing basin retrofit.
- (5) Includes two (2) RAS pump and two (2) WAS pumps, with similar layout as existing RAS/WAS pump station facilities.
- (6) Includes three (3) blowers, with similar layout as existing blower building facilities.
- (7) In December 2021 dollars (ENR CCI 12482).
- (8) Actual project cost may differ if constructed as one project.

This option has an approximate capital cost estimate equal to Option 2 (both significantly less than Option 1) and low operational costs compared to Option 2. Additionally, this layout can be configured to operate in parallel with the existing facility (operating as “Plant 3”), thus enhancing flow split.

Option 3 provides the most benefit to the City at the least cost.

The projected timeline for implementation and project costs for the various facilities that make up Option 3 are summarized in Table 4.4 (Section 4.7) and carried through in Chapter 1 and 7 summary tables.

4.6 Disinfection and Dechlorination

As discussed in Chapter 3, additional disinfection and dechlorination facilities are required by 2033 to adequately treat the projected flows. The location/layout for a new chlorine contact basin, which will be required by 2033 to treat peak flow conditions, is included below as Figure 4.6.



Figure 4.6 Chlorine Contact Basin

-This Page Intentionally Left Blank-

The following improvements are needed as part of the Disinfection Facilities project:

- 1 new chlorine contact basin (CCB).
- CCB inlet basin modifications.
- Additional sodium hypochlorite (SHS) storage and feed pumps.
- Additional sodium bisulfite (SBS) storage and feed pumps.
- Outfall box improvements.
- Ancillary civil, structural, electrical, and instrumentation improvements.

A summary of estimated project component costs is included below as Table 4.5.

Table 4.5 Disinfection System Improvement Costs

Treatment Unit	Estimated Construction Cost ⁽¹⁾⁽²⁾	Estimated Project Cost ⁽¹⁾⁽³⁾
Chlorine Contact Basin ⁽⁴⁾	\$4.1 M	\$5.1 M
SHS and SBS Storage and Feed Facility Improvements ⁽⁵⁾	\$1.3 M	\$1.6 M

Notes:

- (1) Costs are in December 2021 dollars based on ENR-CCI CCI of 12482.
- (2) Includes estimating contingency of 40% applied to total direct cost, general conditions and contractor overhead and profit contingencies at 18% of total direct cost (each), and local sales tax of 7.25% applied to half of the total direct cost.
- (3) Includes project cost factor of 35% for legal, administration, permitting, design, and engineering services during construction.
- (4) Includes cost for CCB inlet basin modifications.
- (5) Includes cost for outfall box modifications.

These costs are carried through in Chapter 1 and 7 summary tables with forecasted implementation by 2033.

As discussed in Chapter 5, it is anticipated that the City will be required to implement alternate disinfection (non-chlorination) by 2047. The City may consider expedited implementation of the alternate disinfection facilities to avoid sunk costs associated with construction of the needed disinfection system upgrade in 2033.

4.6.1 Solids Handling

As discussed in chapter 3, the WPCP solids handling facilities have adequate capacity to support projected flows and loads discussed herein. No project costs are carried through for these facilities.

4.7 Summary of Capacity-Driven Facility Needs

Table 4.6 includes a summary of recommended projects based on anticipated capacity-driven facility needs through 2057, along with predicted timelines for implementation of each and planning level construction and project cost estimates (presented in December 2021 dollars).

The total capacity-driven project cost estimate of \$94.9 M is escalated to December 2026 dollars (\$118.3 M) for the connection payment calculation option presented in Chapter 1 with use of a projected average annual interest rate of 4.5 percent.

Table 4.6 Summary of Capacity-Driven Facility Needs

Projected Timeline for Implementation	Project Description	Estimated Construction Cost ^{(1),(2)}	Estimated Project Cost ^{(1),(3)}
2028	Secondary Clarifier #6 ⁽⁴⁾ (fourth clarifier in Plant 2)	\$8,000,000	\$10,700,000
2032	Supplemental Carbon Project	\$300,000	\$400,000
2033	Chlorine Contact Basin	\$4,100,000	\$5,100,000
2033	Chemical Storage and Feed Facility Improvements (SHS and SBS)	\$1,300,000	\$1,600,000
2036	Southern Pond Improvements for Secondary Expansion	\$700,000	\$900,000
2036	Secondary Clarifier #7 ⁽⁵⁾ (fifth clarifier in Plant 2)	\$10,000,000	\$13,400,000
2036	RAS/WAS Pump Station and Electrical Building ⁽⁶⁾	\$1,300,000	\$1,600,000
2038	Parallel Force Main Improvements	\$800,000	\$1,100,000
2039	Secondary Clarifier #8 (sixth clarifier in Plant 2)	\$10,000,000	\$13,400,000
2044	Aeration Tank #5 ⁽⁷⁾	\$11,700,000	\$15,600,000
2044	Blower and Electrical Building ⁽⁶⁾	\$5,000,000	\$6,300,000
2045	Primary Clarifier #4	\$3,700,000	\$5,000,000
2053	Aeration Tank #6 ⁽⁷⁾	\$11,700,000	\$15,600,000
2054	Primary Effluent Lift Station Improvements	\$1,700,000	\$2,100,000
2054	Bar Screen #3	\$500,000	\$600,000
Total Required Capital Investment		\$72,000,000	\$94,900,000

Notes:

- (1) Costs are in December 2021 dollars based on ENR-CCI CCI of 12482.
- (2) Includes estimating contingency of 40% applied to total direct cost, general conditions and contractor overhead and profit contingencies at 18% of total direct cost (each), and local sales tax of 7.25% applied to half of the total direct cost.
- (3) Includes project cost factor of 35% for legal, administration, permitting, design, and engineering services during construction.
- (4) 100-foot diameter secondary clarifier.
- (5) 125-foot diameter secondary clarifier.
- (6) Based on Secondary Treatment Expansion Option 3 layout (Chapter 4).
- (7) With denitrification improvements (MLE).

Chapter 5

REGULATORY-DRIVEN FACILITY NEEDS

Waste discharge requirements (WDRs) issued for the WPCP reflect both state and federal laws, regulations, and policies related to water quality pollution. As these laws, regulations, and policies become more stringent over time, the need for more advanced wastewater treatment at the WPCP will increase. This chapter includes a summary of facility needs that could be required to comply with these changing regulations, referred to herein as “regulatory-driven facility needs”.

5.1 Existing Discharge Requirements

The effluent discharge requirements for the WPCP are issued by the Regional Water Quality Control Board (RWQCB), Central Valley Region in California. The RWQCB is the regional authority of the State Water Resources Control Board (SWRCB). In addition to the state laws and regulations, the effluent discharge requirements also incorporate federal laws and regulations. This is because the federal Environmental Protection Agency (EPA) has delegated the authority for issuing federal National Pollutant Discharge Elimination System (NPDES) permits to the SWRCB.

The current WDRs for the WPCP are established in Order No. R5-2016-0023 (NPDES No. CA0079081). The Order includes two permitted discharge locations:

- D-001: Discharge to the Sacramento River (surface water discharge).
- D-002: Discharge to the underlying groundwater (land discharge).

Current effluent limitations for discharge to the Sacramento River are summarized in Table 5.1.

Table 5.1 Current Effluent Limitations for Effluent Discharge to the Sacramento River

Parameter	Units	Average Monthly	Average Weekly	Maximum Daily	Instantaneous Minimum	Instantaneous Maximum
Biochemical Oxygen Demand (BOD ₅) (5-day @ 20 degrees Celsius)	mg/L	30	45	90	-	-
	lbs/day(1)	3,002	4,504	9,007	-	-
TSS	mg/L	30	45	90	-	-
	lbs/day(1)	3,002	4,504	9,007	-	-
pH	standard units	-	-	-	6.0	8.5
Ammonia Nitrogen, Total (as N)	mg/L	8.2	17.6	-	-	-
	lbs/day(1)	821	1,761	-	-	-
Copper, Total Recoverable	µg/L	15	-	20	-	-
Chlorodibromomethane	µg/L	17.2	-	34	-	-
Dichlorobromomethane	µg/L	25.2	-	43	-	-
Nitrate Plus Nitrite (as N)	mg/L	60	104	-	-	-

Notes:

- (1) Based on design dry weather flow of 12 mgd.
- (2) Abbreviations – mg/L = milligrams per liter.

Order No. R5-2016-0023 also includes the following effluent discharge requirements for discharges to the Sacramento River:

- *BOD and TSS*: average monthly percent removal shall be no less than 85 percent for each.
- *Toxicity*: survival of aquatic organisms in 96-hour acute whole effluent toxicity bioassays shall be no less than 70 percent (minimum for any one bioassay) and 90 percent (median for any three consecutive bioassays). The Order also includes a numeric toxicity monitoring trigger for chronic whole effluent toxicity of > 10 TUc (where TUc = 100/NOEC [no observed effect concentration]).
- *Total residual chlorine*: shall not exceed 0.011 mg/L (4-day average) and 0.019 mg/L (1-hour average).
- *Total coliform organisms*: shall not exceed 23 most probable number (MPN) per 100 milliliter (mL) (7-day median) and 240 MPN/100 mL (more than once in any 30-day period).
- *Combined chlorpyrifos and diazinon concentration*: The Order specifies that the combined concentration for chlorpyrifos and diazinon shall not exceed 1.0 µg/L as a weekly or monthly average concentration in the discharged effluent.

Future limitations for effluent discharge to the facility's ponds (Land Discharge Specifications) are summarized in Table 5.2. These effluent limitations were scheduled to take effect on May 30, 2021.

Table 5.2 Future Effluent Limitations for Land Discharge

Parameter	Units	Average Monthly	Average Weekly	Daily Maximum
BOD ₅	mg/L	30	45	-
(5-day @ 20 deg. Celsius)	lbs/day ⁽¹⁾	626	939	-
TSS	mg/L	30	45	-
	lbs/day ⁽¹⁾	626	938	-
Total Coliform Organisms	MPN/100 mL	-	23 ⁽²⁾	240 ⁽³⁾

Notes:

- (1) Based upon an average monthly flow of 2.5 mgd.
- (2) Based upon a 7-day median concentration.
- (3) Shall not be exceeded more than once in any 30-day period.

5.1.1 Status of NPDES Permit Order

Order No. R5-2016-0023 expired on May 31, 2021 but has been administratively extended by the Regional Water Quality Control Board (RWQCB) as they draft a renewed Order for the WPCP in parallel with the development of this report.

5.2 Previous Projection of Regulatory-Driven Facility Needs at the WPCP

The WPCP Strategic Planning Report¹ included a detailed summary of existing WDRs for the WPCP; a listing of state and federal requirements applicable to the WPCP with analysis of how these requirements may change over time based on historical and ongoing activities; and an analysis of probable future effluent limits. Probable future effluent limitations outlined in the WPCP Strategic Planning Report² are repeated here as Table 5.3 for reference.

¹ (Carollo Engineers, 2021)

² (Carollo Engineers, 2021)

Table 5.3 Summary of Probable Future Effluent Limitations

Parameter	Unit	Probable Effluent Limit	Averaging Period ⁽¹⁾	Proposed Treatment
BOD ₅ (5-day @ 20°C)	mg/L	10/15/30	Monthly/Weekly/Daily	Tertiary Filtration
TSS	mg/L	10/15/30	Monthly/Weekly/Daily	Tertiary Filtration
pH	standard units	6.0/8.5	Instantaneous Minimum/Maximum	N/A
Ammonia Nitrogen, Total (as N)	mg/L	8.2/17.6 ⁽²⁾	Monthly/Weekly	N/A
Copper, Total Recoverable	µg/L	15/20	Monthly/Daily	Potentially Filtration ⁽³⁾
Chlorodibromo-methane	µg/L	17.2/34.0	Monthly/Daily	Alternative Disinfection ⁽³⁾
Dichlorobromo-methane	µg/L	25.2/43.0	Monthly/Daily	Alternative Disinfection ⁽³⁾
Nitrate Plus Nitrite (as N)	mg/L	10 ⁽⁵⁾	Monthly	Denitrification Upgrades
Bis (Di-2-ethylhexyl)-phtalate (DEHP)	µg/L	1.8/3.6 ⁽⁵⁾	Monthly/Daily	Potentially Filtration
Lead	µg/L	1.3/2.8 ⁽⁵⁾	Monthly/Daily	Potentially Filtration
Zinc	µg/L	300 ⁽⁵⁾	Average Annually	Potentially Filtration

Notes:

- (1) Monthly and weekly values are average effluent concentration limitations. Daily value is maximum effluent concentration limitation.
- (2) Ammonia limits may be reduced with implementation of 2013 Criteria.
- (3) Would be required if current limits are reduced during future permit renewals due to mixing zone limitations (or other).
- (4) Current permit limitations are 60/104 mg/L (average monthly/average weekly).
- (5) Assumes no dilution credit assignment, which is currently considered conservative.

The WPCP Strategic Planning Report³ also included a summary of probable regulatory-driven facility needs based on the prediction of near-term and longer-term regulatory drivers and the planning horizon in question at the time of analysis (through 2040). Based on the analysis completed for the WPCP Strategic Planning Report⁴, the following regulatory-driven needs were projected for the WPCP:

- Required improvements for land discharge of treated effluent:
 - If City preferred to continue discharging treated effluent to the ponds, denitrification upgrades would be needed by 2024.
 - If City preferred to continue discharging partially treated effluent to the ponds during facility upset conditions, a project would be needed by 2026 to install a lining over a portion (or all) of the WPCP Southeast and/or Northeast ponds.
- Addition of tertiary treatment facilities at the WPCP (assumed required in 2021 permit, with full implementation by 2031).
- Required improvements for reduction of Di(2-ethylhexyl)phthalate (DEHP), lead, and zinc concentrations in the treated effluent, with implementation by 2031⁵:
 - All possibly reduced with implementation of MLE and tertiary filtration improvements, assuming optimized chemical addition.
- Required improvements for reduction of disinfection byproduct (DBP) concentrations in the treated effluent, with implementation by 2036¹:
 - Treatment with alternative disinfection facilities.

The WPCP Strategic Planning Report⁶ included an evaluation of project alternatives for each of these capital requirements, with potential layout options, operational and capital cost estimates, qualitative comparisons based on related project experience, and the presentation of recommendations for City planning and future implementation. The evaluation of project alternatives for the regulatory-driven needs at the WPCP is not recreated herein, but updated facility sizing, project costs, and projected timeline for implementation of the previously selected project alternatives is.

5.3 Revised Schedule and Sizing Criteria

With ongoing participation from both the State Water Resources Control Board (SWRCB) and the RWQCB in the Sewer Regional Project Advisory Committee (SRPAC) associated with the potential connection of the Paradise sewer to the WPCP, the City has had the opportunity to discuss the projected regulatory needs for the facility with both agencies, obtaining productive feedback related to timelines for implementation of the regulatory-driven facility needs previously identified.

The projections made in the WPCP Strategic Planning Report⁷ for regulatory-driven facility needs are modified herein based on the following discussions:

³ (Carollo Engineers, 2021)

⁴ (Carollo Engineers, 2021)

⁵ If existing mixing zone/dilution credit allowances were to become more stringent, with newly identified reasonable potential, or with failure of other non-treatment options evaluated in parallel.

⁶ (Carollo Engineers, 2021)

⁷ (Carollo Engineers, 2021)

- Meeting with the City, RWQCB, and Carollo on December 10, 2021:
 - Pond lining will not be required for an emergency bypass pond. The City will be protected against non-compliance (during facility upset conditions) if they pursue a project to store bypassed effluent into a pond area that can be drained back to the influent side of the WPCP. This should occur in the near-term.
 - The permit order currently being drafted by the RWQCB will not require the implementation of denitrification upgrades at the WPCP. The City should plan for this requirement to be included within the next permit cycle (likely adoption in 2027) with implementation required prior to permit expiration (assumed 2032).
- Meeting with the City, RWQCB, SWRCB, Paradise, Carollo, and HDR on December 22, 2021:
 - Tertiary filtration will not be required within the next two permit cycles. The City should plan for this requirement to be included in the following permit cycle (likely adoption in 2032) with a 10-year compliance order for implementation (assumed 2042).
 - Alternate disinfection (if required) will not be included within the next three permit cycles. The City could plan for this requirement to be included in the permit cycle following the one that requires tertiary filtration (likely adoption in 2037) and can also anticipate that the City would be allowed a 10-year compliance order for implementation (assumed 2047).

Regulatory-driven needs at the WPCP are also updated herein based on modified flow and load projections completed as part of this planning effort (Chapter 2). Related facility sizing and project cost adjustments are discussed in the following sections.

5.4 Updated Projection of Regulatory-Driven Facility Needs at the WPCP

5.4.1 Required Improvements for Land Discharge

Adjustments to the recommended facility improvement projects for land discharge originally included in the WPCP Strategic Planning Report⁸ are discussed in the following sections.

5.4.1.1 Emergency Effluent Bypass, Storage, and Return Improvements

If the City decides to continue to use the existing WPCP ponds for emergency storage of treated effluent that does not comply with land-discharge requirements (i.e., bypassed flows during facility upset conditions), then an improvement project of some sort will be needed to protect the City from non-compliance with land-discharge specifications. Project alternatives previously presented for this were all costly due to the assumed need for a pond liner. The RWQCB agreed during a meeting on December 10, 2021 that a pond liner would not actually be required if the City can return flow to the front of the WPCP for treatment within a reasonable time following bypass. A modified alternative project for effluent bypass, storage, and return to the front of the WPCP for treatment is presented in Figure 5.1.

⁸ (Carollo Engineers, 2021)

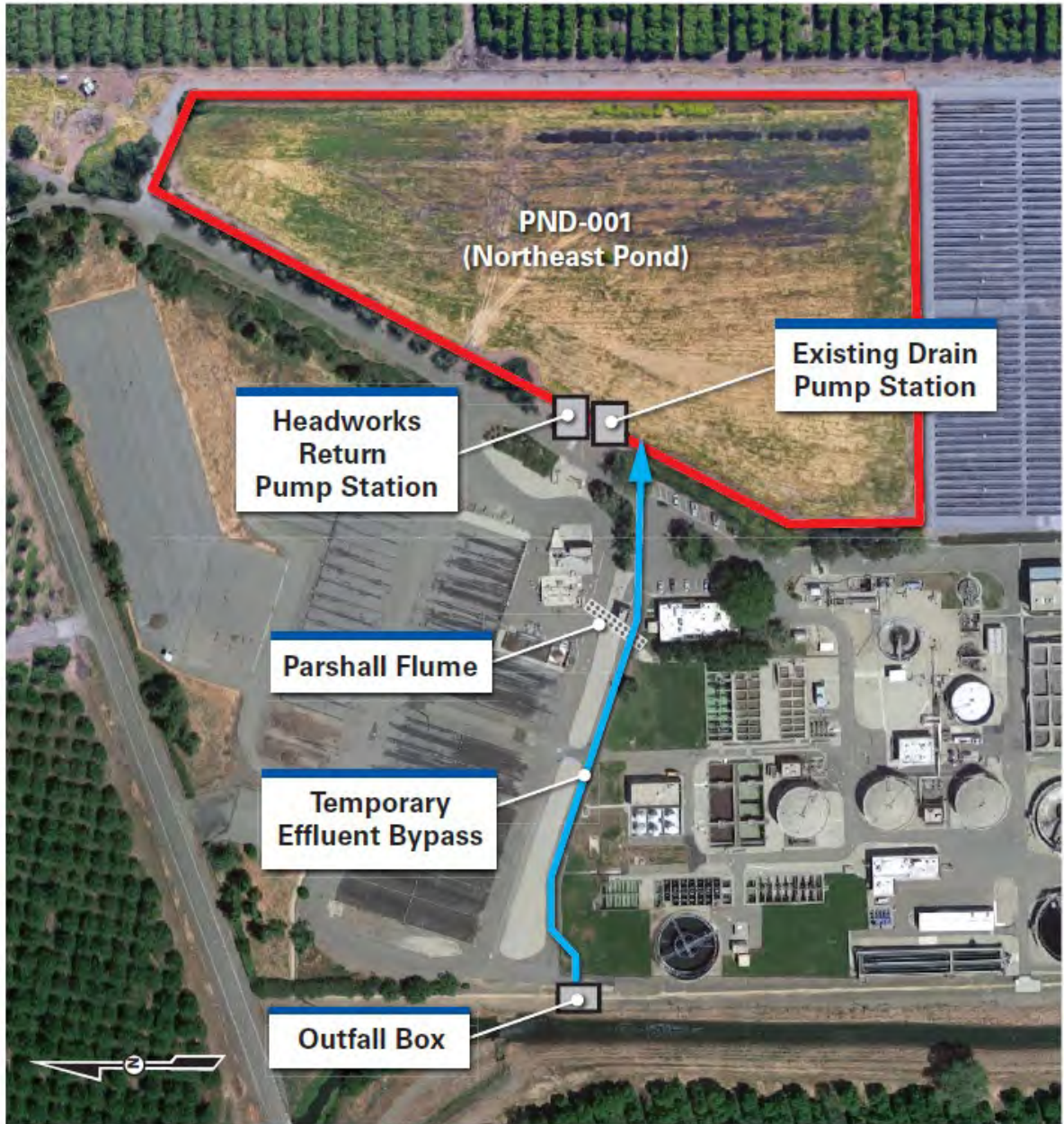

Figure 5.1 Emergency Effluent Bypass, Storage, and Return Improvements

-This Page Intentionally Left Blank-

The following improvements are needed for this effluent bypass, storage, and return project:

- Removal of approximately 10 feet of soil across pond area to increase storage capacity to 25 million gallons.
- Installation of diversion piping between the existing outfall box and the Northeast pond.
- Installation of 3 MGD pump station to assist with return pumping of the bypassed effluent to the headworks facility (in conjunction with existing drain pump station to achieve maximum drainage time of 4 days).
- Ancillary stripping and grading efforts.
- Ancillary electrical and instrumentation upgrades.

The estimated costs for the emergency effluent bypass, storage, and return improvements presented herein are \$7.1 million (construction cost) and \$8.5 million (project cost), both in December 2021 dollars. This cost is carried through in Chapter 1 and 7 summary tables with forecasted implementation by 2027.

As facility flow increases throughout the new planning period (2057), the need for additional bypass storage capacity at the WPCP will need to be revisited.

5.4.1.2 Denitrification Upgrades

The secondary treatment process currently nitrifies (removes ammonia) but only includes partial denitrification (conversion of nitrates and nitrites into nitrogen gas for release into the atmosphere). It is anticipated that effluent limitations for nitrate will become more stringent over time with a likely requirement to implement denitrification at the WPCP by 2032. The Pond/Facility Improvement Options TM⁹ included a recommendation to implement a Modified Ludzack-Ettinger (MLE) process within the existing Plant 2 aeration tanks for this purpose.

The MLE process requires an anoxic zone upstream of the aerobic zone to facilitate the biological denitrification reaction. For incorporation of this process into the existing aeration tanks (as depicted in Figure 5.2), the anaerobic zone for each tank will be converted to an anoxic zone by pumping mixed liquor (ML) from the effluent end of the tank to the anoxic zones at the influent end of the tank. This requires the installation of mixed liquor recycle pumps as depicted in Figure 5.2.

⁹ (Carollo Engineers, 2019)

-This Page Intentionally Left Blank-

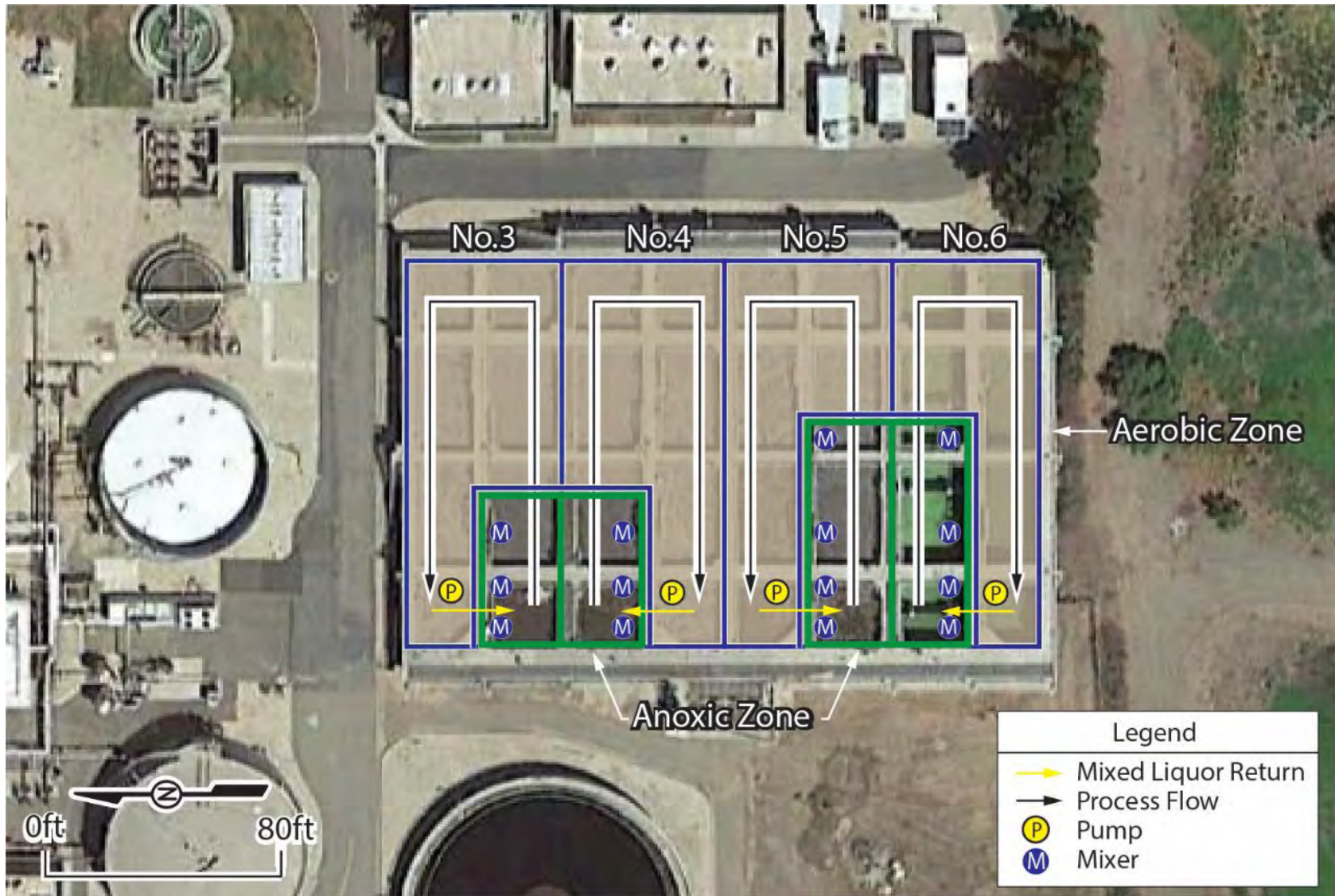

Figure 5.2 Process Conversion from Nitrifying Activated Sludge to Modified Ludzack-Ettinger

-This Page Intentionally Left Blank-

The following improvements are needed to upgrade the existing secondary process to MLE:

- Addition of four 7.5 mgd MLE pumps:
 - One pump per tank, with shelf-spare on hand.
- Addition of fourteen 6-horsepower submersible mixers.
- Piping, electrical, instrumentation, and ancillary items.

The estimated project cost for these upgrades was originally presented in the Pond/Facility Improvement Options TM (Carollo Engineers, 2019). The updated project cost for these upgrades is approximately \$4,400,000 (in December 2021 dollars). This cost is carried through the in Chapter 1 and 7 summary tables with forecasted implementation by 2032.

5.4.2 Tertiary Treatment

Tertiary treatment is likely to be required within the next few NPDES permit cycles with reduced BOD/TSS limits (and likely turbidity limit of 2 Nephelometric turbidity units [NTU]). This level of treatment is typically accomplished with filtration, which is a process that removes suspended solids that remain in treated flow after the secondary clarification process.

The following industry leading filtration methods were evaluated as alternatives in the WPCP Strategic Planning Report¹⁰:

- Dual media filtration.
- Cloth disk filters.
- Membrane filtration.

Following a detailed comparison involving project costs, annual O&M costs and labor requirements, relative footprint needs/limitations, and ability to meet future water quality goals (near- and long-term), cloth disk filters were selected as the chosen alternative for planning purposes. Design criteria, facility sizing and layout, and related project costs are updated herein for this filter technology only.

5.4.2.1 Filter Design Flow and Flow Equalization

The requirement to filter the effluent flow could be based on the AAF or PF, depending on the final permit requirements. The more conservative assumption is that the permit will require that the peak facility flow be filtered. In this case, flow equalization could be considered to reduce filter size and capital costs. Providing flow equalization for the PF may be possible, but it is not considered within this evaluation as there are many other key considerations (and because flow equalization may not actually save the City money). Instead, filters are sized to provide filtration for the PF without redundancy, with a normal redundancy requirement included for treatment of the MMF.

5.4.2.2 Filter Loading Rate

Title 22 regulations for recycled water require a maximum loading rate of 6 to 7 gpm/sf, depending on the cloth type used. Higher loading rates (up to 22 gpm/sf) are possible if specific design and monitoring conditions are met.

¹⁰ (Carollo Engineers, 2021)

The filters for the WPCP will not be required to meet Title 22 standards unless the City wishes to implement a water recycling program in the future. For planning purposes, non-Title 22 conforming loading rates are used herein for facility sizing and related project cost estimates.

5.4.2.3 Cloth Disk Filters

Cloth disk filters are vertical disks located within concrete or steel tanks. For the vendors considered within this study, water flows by gravity from the outside of the disks, through the vertical disk media, to an effluent collection pipe, and into an effluent chamber. Figure 5.3 illustrates the configuration of a basic disk filter.

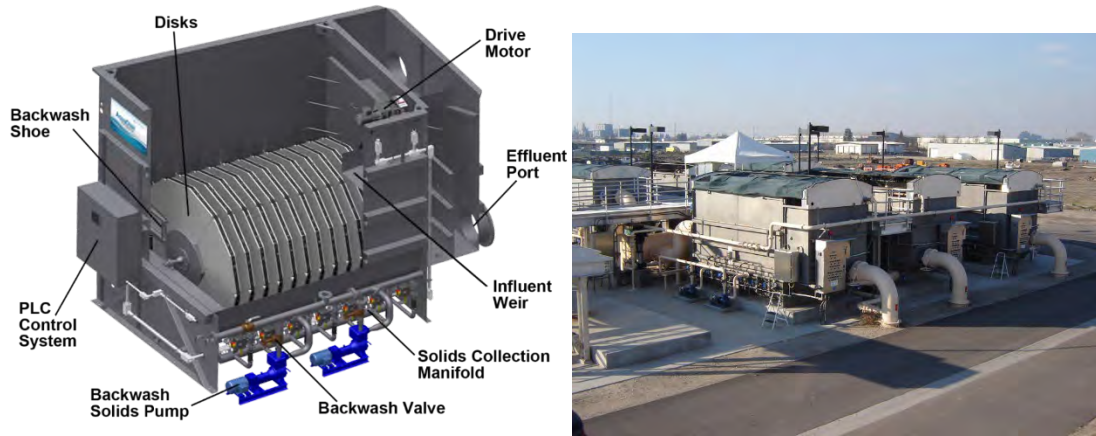

Figure 5.3 Configuration of Basic Disk Filter

Courtesy of Aqua Aerobics (Left) and Disk Filters at Turlock Regional Water Quality Control Facility (Right)

Backwashes are conducted through a suction foot that vacuums each disk using filtrate water. Unlike some other conventional filters, cloth filters can be backwashed while still producing effluent. As such, the downtime for disk filters is minimized. Additionally, since backwashing uses the filtrate directly on the other side of the media, there is no need for a backwash supply tank (reducing overall footprint and cost).

Disk filters were very popular in the early 2000s for their reduced footprint requirement, low head loss, and continuous flow production throughout backwashing. They also have a reduced energy requirement compared to other filter technologies because they operate with gravity flow. However, where dual media filters are robust, cloth media disk filters require a relatively high-quality influent (consistent turbidity less than 5 NTU and TSS lower than 15 mg/L) to produce a high-quality effluent. Flows with turbidity values above 5 NTU can cause downstream compliance issues if upstream coagulant addition is not used to optimize treatment. Coagulant addition must be carefully handled because too much coagulant can easily clog cloth filters. With the proper influent or upstream chemistry, disk filters are a good solution downstream of a nitrified secondary treatment process.

Though not monitored regularly, available data indicates that the WPCP has low effluent turbidity as flow exits the secondary clarifiers. Thus, regular chemical addition may not be required. Upgrading the secondary treatment process to include denitrification is not expected to adversely affect the effluent water quality if sufficient clarification capacity is available. The City should monitor effluent turbidity values after the MLE process is implemented, so that adequate information will be available for filtration system design.

Projected design criteria for disk filters for the WPCP is summarized in Table 5.4.

Table 5.4 Cloth Disk Filter Design Criteria

Design Criteria	Value	Units
Design Average Flow ⁽¹⁾	21.8	mgd
Peak Hour Flow ⁽²⁾	39.6	mgd
Tertiary Lift Station ⁽³⁾	120	hp
Number of Filters (Duty+Standby)	4 (3+1)	No.
Filter Cell Length (each)	25	ft
Filter Cell Width (each)	13	ft
Number of Disks per Unit	15	No.
Filtration Area Provided (N-0)	6,456	sf
Filtration Area Provided (N-1)	4,842	sf
Filter Loading Rate at Peak Flow (N-1)	5.7	gpm/sf
Filter Loading Rate at Design Flow (N-1)	3.1	gpm/sf
Backwash Pumps (Duty+Standby)	4 (3+1)	No.
Backwash Pump Motor Power (each)	20	hp
Backwash Waste	Pumped Direct to Headworks	
Overall Footprint ⁽⁴⁾	60' x 60'	ft

Notes:

- (1) Projected WPCP maximum month flow through end of planning cycle (2057).
- (2) Projected WPCP peak hour flow through end of planning cycle (2057).
- (3) Assumes three duty 30-hp pumps and one standby 30-hp pump.
- (4) Filter includes pumping room and disk filters.

A potential layout for the disk filters at the WPCP is included as Figure 5.4. Effluent from the secondary clarifiers will be routed through the disk filters and then to the influent side of the existing chlorine contact basins (as shown).

-This Page Intentionally Left Blank-



Figure 5.4 Potential Layout for Disk Filter Facilities at WPCP

-This Page Intentionally Left Blank-

The following improvements are needed to implement disk filtration at the WPCP:

- Construction of four disk filter cells with area and disk details summarized in Table 5.3.
- Addition of a tertiary lift station to pump effluent from the secondary clarifiers into the disk filter facility.
 - Three duty pumps at build-out flows, one standby.
- Addition of piping between the tertiary lift station and the influent side of the disk filter facility.
- Addition of piping between the effluent side of the disk filter facility and the influent side of the existing chlorine contact basin.
- Addition of backwash pump station.
- Demolition of existing shop building.
- Ancillary civil, mechanical, electrical, and instrumentation items.

The estimated costs for the cloth disk filters are \$16.8 million (construction cost) and \$22.7 million (project cost), both in December 2021 dollars. This cost is carried through in Chapter 1 and 7 summary tables with forecasted implementation by 2042.

Cost estimate details are included herein as Appendix A.

5.4.3 Requirements for DEHP, Lead, and Zinc Compliance

Recommended strategies for long-term DEHP, lead and zinc compliance were discussed in detail in the WPCP Strategic Planning Report, with study cost estimates included for CIP planning. These discussion and related costs are not repeated herein for simplicity, because the planning period is long and detailed compliance requirements will continue to evolve throughout the planning period, and because this type of work will more likely be covered under the City's operational budget (which is adjusted annually to account for these variable needs at the WPCP). The City should review related needs with each NPDES permit renewal cycle.

5.4.4 Alternative Disinfection

The Chico WPCP currently uses sodium hypochlorite for free chlorine disinfection. The current disinfection regulations include a monthly average total coliform limit of 23 MPN per 100 mL, which the WPCP can consistently meet with current chlorine dosing practices. However, two major regulatory requirements will require a recurring re-examination of the disinfection system:

- Possible reduction of effluent water quality limitation to 2.2 MPN per 100 mL.
- Possible future stringent regulation of DBPs.

While existing DBP effluent limitations (for chlorodibromomethane and dichlorobromomethane) have not been exceeded, an increased level of disinfection (to meet 2.2 MPN per 100 mL) may require higher chlorine doses or contact time (potentially leading to increased DBP formation). Additionally, the WPCP's ability to comply with DBP limits relies heavily on continued allowance of dilution credits by the RWQCB as included in the current permit Order. If dilution credits for these DBPs (or others that may be identified in future reasonable potential analyses) are reduced or eliminated, then an alternate disinfection process may be required.

The following disinfection alternatives were analyzed with respect to their DBP formation potential and their ability to comply with the more stringent total coliform limit projected in the WPCP Strategic Planning Report¹¹:

- Ozone disinfection.
- Ultraviolet disinfection (UV) constructed within existing chlorine contact basin (CCB) channels.
- UV disinfection in a standalone structure.
- Testing and adjustment of existing chlorination practices.

Following a detailed comparison summarized in the WPCP Strategic Planning Report¹² involving project and operational costs, reliability of treatment process, relative footprint needs/limitations, and ability to meet future water quality goals (near- and long-term), UV disinfection in a standalone structure was selected as the chosen alternative for planning purposes. Design criteria, facility sizing and layout, and related project costs are updated herein for this option only.

5.4.4.1 UV Disinfection

UV disinfection is popular due to its efficiency, lack of toxicity, and lack of DBP formation. UV has a high efficiency for bacterial, virus, and protozoa disinfection, and it does not need to be quenched before discharge.

UV Design Assumptions

Ultraviolet transmittance (UVT) is a key design criteria for UV system design, alongside UV dose and wastewater flow. For the WPCP UV design, a process capacity of the peak hour flow (39.6 mgd) was assumed, along with a UVT of 55 percent (which is a typical low value for wastewater effluent). It is probable that after filtration, the UVT of the filtered flow will increase, potentially requiring a reduced number of UV lamps. For planning purposes, the conservative value of 55 percent UVT is used in this evaluation.

Other projected design criteria for the UV system for the WPCP is summarized in Table 5.5.

¹¹ (Carollo Engineers, 2021)

¹² (Carollo Engineers, 2021)

Table 5.5 UV Facility Design Criteria

Parameter	Value
Peak Hour Flow Rate (mgd)	39.6
Maximum Month Flow Rate (mgd)	21.7
Average Annual Flow Rate (mgd)	17.1
Design UV Transmittance (%)	55.0
Minimum MS2 RED (mJ/cm ²), per NWRI 2012	105.0
Total Suspended Solids	
Average Monthly (mg/L)	10
Average Weekly (mg/L)	15
Maximum Daily (mg/L)	20
Redundancy	Meet Design Dose at Maximum Day Flow with one channel out of service
Permit Limit, shall not exceed:	
Total Coliform, 7-day median	2.2 MPN/100 mL
Total Coliform, more than once in any 30-day period	23 MPN/100 mL
Total Coliform, at any time	240 MPN/100 mL
Abbreviation: ED = reduction equivalent dose	

A potential layout for the new UV facility at the WPCP is included as Figure 5.5. Effluent from the new disk filter facility will be routed to the influent end of the UV facility, through the new UV equipment, and disinfected effluent will then flow to the existing outfall box for discharge to the Sacramento River.

-This Page Intentionally Left Blank-

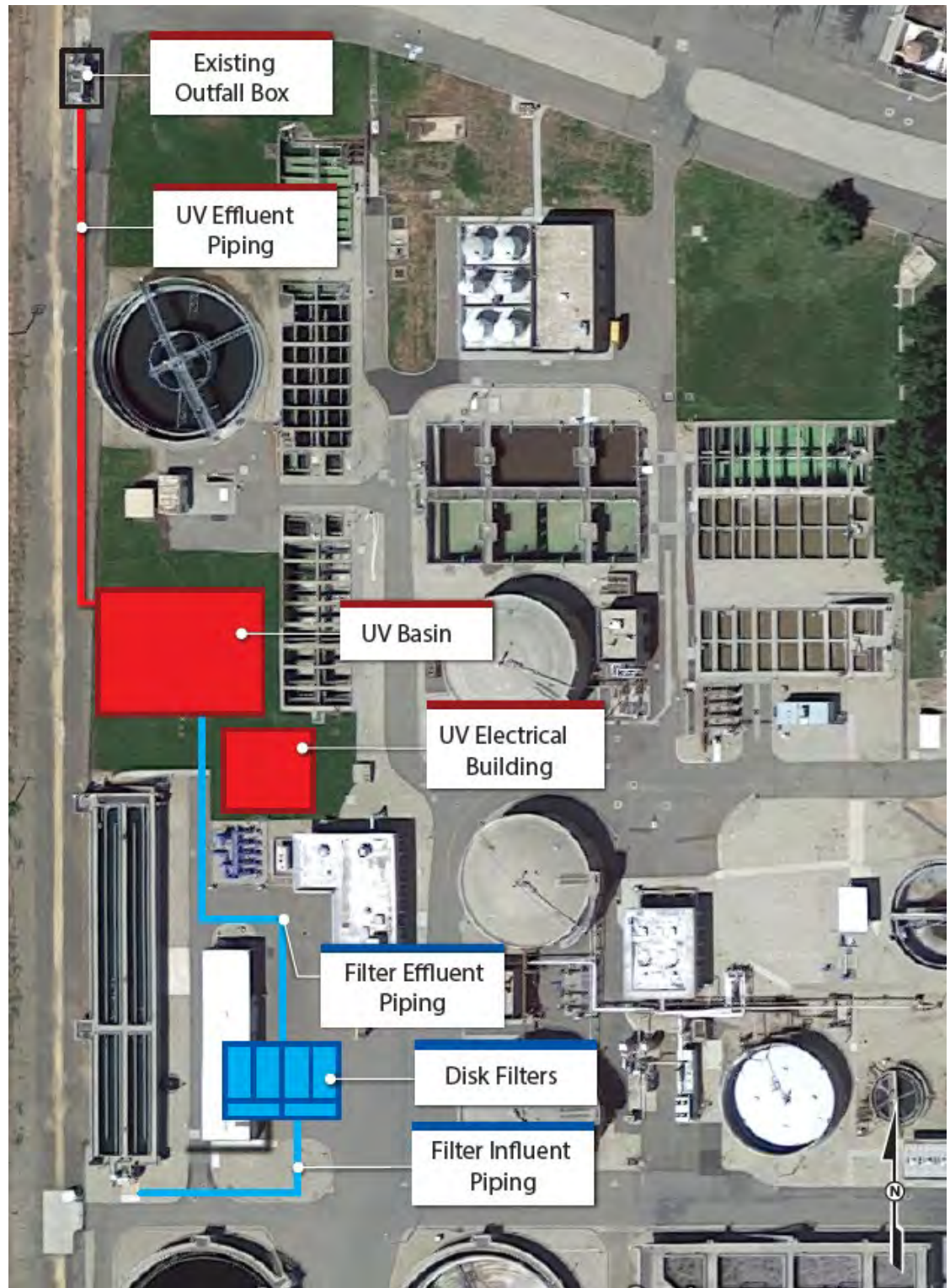

Figure 5.5 Potential Layout for UV Disinfection Facilities at the WPCP

-This Page Intentionally Left Blank-

The following improvements are needed to implement UV disinfection at the WPCP:

- Construction of UV facility.
- Addition of piping between the effluent side of the disk filter facility and the influent side of the UV facility.
- Addition of piping between the effluent side of the UV facility and the existing outfall box.
- Construction of UV Electrical Building.
- Ancillary civil, mechanical, electrical, and instrumentation items.

The estimated costs for the proposed UV facilities is \$30.2 million (construction cost) and \$40.8 million (project cost), both in December 2021 dollars. This cost is carried through in Chapter 1 and 7 summary tables with forecasted implementation by 2047.

Cost estimate details are included herein as Appendix A.

-This Page Intentionally Left Blank-

Chapter 6

CONDITION-DRIVEN FACILITY NEEDS

Condition-driven needs for the WPCP were evaluated as part of detailed visual assessment of facility assets in 2018 by a multi-disciplinary condition assessment team. Methodology and findings of this assessment are summarized in the WPCP Strategic Planning Report¹. This analysis, including extension of the planning period from 2040 to 2057 as described in Chapter 1, was not updated as part of this planning exercise. The condition-driven improvement recommendations from this original assessment are repeated herein for Plant 2 to allow for a complete picture of facility needs through 2040, with simple updates provided for related project costs.

6.1 Summary of Near-Term Condition Driven Needs

Although the Plant 2 facilities have been well maintained, some elements are nearing the end of their useful lives and will require attention. Table 6.1 includes a summary of near-term improvements that would be required to maintain Plant 2 operational reliability.

¹ (Carollo Engineers, 2021).

Table 6.1 Summary of Near-Term Plant 2 Condition-Driven Needs

Process Area	Required Improvement	Timeline for Implementation ⁽¹⁾	Estimated Project Cost ⁽²⁾
Primary Treatment	Basin rehabilitation ⁽³⁾ Equipment replacement ⁽⁴⁾	< 5 years	\$3,680,000
Aeration	Equipment replacement ⁽⁵⁾	< 5 years	\$880,000
Secondary Treatment	Equipment replacement ⁽⁶⁾	< 5 years	\$980,000
Disinfection	Equipment replacement ⁽⁷⁾	< 5 years	\$840,000
Chemical Building	Equipment replacement ⁽⁸⁾	< 5 years	\$190,000
Solids Thickening	Equipment replacement ⁽⁹⁾	< 5 years	\$350,000
Solids Digestion	Equipment replacement ⁽¹⁰⁾	< 5 years	\$2,370,000
Solids Dewatering	Equipment replacement ⁽¹¹⁾	< 5 years	\$540,000
Plant Power Systems	Equipment replacement ⁽¹²⁾	< 5 years	\$10,000
Other Plant Systems	Equipment replacement ⁽¹³⁾	< 5 years	\$740,000
Total Near-Term Required Capital Investment			\$10,580,000

Notes:

- (1) These recommendations were originally made (as listed) in 2018.
- (2) Costs are escalated from those presented in the WPCP Strategic Planning Report based on December 2021 dollars using an ENR-CCI 20 Cities Index of 12482. Original cost estimating assumptions and limitations are discussed therein.
- (3) Includes concrete repair and rehabilitation, replacement of gates and actuators, all process instrumentation, and spot repair/rehabilitation of process piping.
- (4) Includes replacement of sludge collector motor and chains for Primary Clarifier Nos. 1 and 2, pit pumps for Primary Clarifier Nos. 1 and 2, primary effluent pump motors (pumps No. 2 and 3), replacement of PLC-H, and ancillary items.
- (5) Includes replacement of Blower No. 7, air diffuser and air flow meters in Aeration Basin Nos. 3 and 4, PLC-B, and ancillary items.
- (6) Includes replacement of sludge collectors for Secondary Clarifier Nos. 3 and 4, replacement of MCC-EP-1, MCC-P1, and PLC-R, and ancillary items.
- (7) Includes replacement of flash mixers for Chlorine Contact Basin Nos. 3 and 4, gates and actuators, flow meters, sampling pumps, PLC-C, and ancillary items.
- (8) Includes replacement of CSS Pump Nos. 1 and 2, SBH Recirculation Pump No. 1, SHS Pump No. 1, PLC-C, and ancillary items.
- (9) Includes replacement of Recycle Pressurization Pump Nos. 1-4, air compressors for DAFT Nos. 1 and 2, polymer feed system, MCC-EP5, PLC-B-I/02, and miscellaneous items.
- (10) Includes improvements to Boiler Building No. 2 and replacement of Sludge Heater Nos. 1-3, digester gas flow meters, PLC-D, and ancillary items.
- (11) Includes replacement of Screw Conveyor No. 1, solids grinder, miscellaneous exhaust/supply fans, flow meters, and unit heaters, PLC-B2-I/02, and ancillary items.
- (12) Includes replacement of LCP-PCP-47.
- (13) Includes replacement of Deep Well Pump Nos. 1 and 2, MCC-PC/EP-2, and ancillary items.

6.2 Summary of Long-Term Condition Driven Needs

Table 6.2 includes a summary of long-term condition-driven project costs for Plant 2 facilities.

Table 6.2 Summary of Long-Term Plant 2 Condition Needs

Process Area	Required Improvement	Timeline for Implementation ⁽¹⁾	Estimated Project Cost ⁽²⁾
Headworks	Equipment rehabilitation/replacement ⁽³⁾	2029 - 2039	\$3,180,000
Primary Treatment	Equipment replacement ⁽⁴⁾	2025 - 2039	\$4,160,000
Aeration	Equipment replacement ⁽⁵⁾	2027 - 2039	\$1,900,000
Secondary Treatment	Equipment replacement ⁽⁶⁾	2027 - 2039	\$2,390,000
Disinfection	Equipment replacement ⁽⁷⁾	2027 - 2039	\$1,080,000
Chemical Building	Equipment replacement ⁽⁸⁾	2029 - 2038	\$510,000
Solids Thickening	Equipment replacement ⁽⁹⁾	2027 - 2039	\$1,210,000
Solids Digestion	Equipment replacement ⁽¹⁰⁾	2027 - 2040	\$6,210,000
Solids Dewatering	Equipment replacement ⁽¹¹⁾	2027 - 2039	\$5,790,000
Plant Power Systems	Equipment replacement ⁽¹²⁾	2027 - 2039	\$7,210,000
Other Plant Systems	Equipment replacement ⁽¹³⁾	2027 - 2039	\$420,000
Total Long-Term Required Capital Investment			\$34,060,000

Notes:

- (1) These recommendations were originally made (as listed) in 2018.
- (2) Costs are escalated from those presented in the WPCP Strategic Planning Report based on December 2021 dollars using an ENR-CCI 20 Cities Index of 11699. Original cost estimating assumptions and limitations are discussed therein.
- (3) Includes replacement of major mechanical equipment items (shaftless screw conveyor, mechanical bar screens, screenings washer/compactors, vortex grit chamber drives, grit cyclone separators, ferric facility pumps biofilter fans, grit basement exhaust and supply fans, flow meters/transmitters, sump pumps, analyzers, samplers, etc.) (in 2029); and replacement of grit pumps, channel gates, and MCC-P14 (in 2039).
- (4) Includes rehabilitation of Primary Clarifier No. 3 (motor and chains, sludge collector drives, chains, etc), replacement of Primary Effluent Pumps Nos. 1-3 (with new VFDs), and ancillary items (in 2027); replacement of MCC-EP7 and PLC-X (in 2029); miscellaneous items (2030 - 2036); and replacement of Primary Effluent Pump No. 4 and MCC-P13 (in 2039).
- (5) Includes replacement of tank inlet/outlet gates and MCC-P8 (in 2027); DO meters (in 2028); air diffusers and flow meters for Aeration Basin Nos. 5 and 6, exhaust and supply fans for Blower Building No. 2, and PLC-BB (in 2029); air inlet and blow off valves (in 2032); miscellaneous items (2034-2036); and Blower No. 8, and inlet and outlet gates for Aeration Basin Nos. 5 and 6 (in 2039).
- (6) Includes replacement of sludge collector drive for Secondary Clarifier No. 3, RAS Pump Nos. 4-7, MCC-P11A, and SWGP-1 (in 2027); MCC-P11 and PLC-RR (in 2029); miscellaneous flow meters and heat pumps (in 2036); and the sludge collector drive for Secondary Clarifier No. 5, RAS Pump No. 9, and Secondary Scum Pump No. 5 (in 2039).
- (7) Includes replacement of sluice gates (in 2027), miscellaneous flow meters, analyzers, and sample pumps (2028-2035), and the hydraulic power unit and sluice gates (in 2039).
- (8) Includes replacement of MCC-P12, SBS recirculation Pump No. 2, and miscellaneous heat pumps, unit heaters, exhaust fans, and instrumentation (in 2029); and replacement of SBS Pump Nos. 1 and 2 and SHS Pumps 2-4 (in 2038).
- (9) Includes replacement of DAFT No. 2 collector drive, TWAS Pump Nos. 1-4, Thickened Sludge Grinder Nos. 1 and 2, instrumentation for DAFT Nos. 1 and 2, and MCC-P13 (in 2029); DAFT No. 1 collector drive (in 2032); and Thickened Sludge Pump Nos. 1 and 2 (in 2039).
- (10) Includes replacement of Digester No. 3, most digester transfer/recirculation pumps and Sludge Mixing Pump Nos. 1-3 (in 2027); MCC-P15, MCC-P9, PLC-X, and miscellaneous items (in 2029); miscellaneous flow meters, inlet valves (2030-2036); and Digester Transfer Pump No. 2, Sludge Mixing Pump No. 4, Digester Recirculation Pump No. 3, and Hot Water Loop Pump Nos. 1-3 (in 2039).
- (11) Includes replacement of Centrifuge No. 1 and miscellaneous control and starter panels (in 2027); Screw Conveyor Nos. 2 and 3, Polymer Mixing Pump Nos. 1-2, Polymer Blending Pump Nos. 1-2, and MCC-P10 (in 2029); miscellaneous items (2030-2037); and Centrifuge No. 2, Centrifuge Feed Pump Nos. 1-2, and ancillary items (in 2039).
- (12) Includes replacement of solar power system, Switchboard-P2, Transformer No. 1, and Standby Generator No. 2 Control Panel (in 2027); Substation No. 1, Panel-P9A, and miscellaneous electrical items (in 2029); the cogeneration unit (in 2034); Standby Generator No. 2 and the synchronizer panel for Generator Nos. 1-2 (in 2037); and the cogeneration hot water loop and control panels for Standby Generator No. 3 and 4 (in 2039).
- (13) Includes replacement of 3W Pump Nos. 1-4 and main hot water pumps (in 2027); miscellaneous items (2029-2032), and 3W Pump No. 5 (in 2039).

6.3 Options for Reduced or Deferred Capital Expenditure

The WPCP Strategic Planning Report² identified four projects as unnecessary following related discussions with the City staff after completion of the on-site condition assessment:

- Rehabilitation/replacement of gravity thickener and thickened sludge pump equipment:
 - These facilities were not in use at the time of the analysis, following completion of facility upgrades that have allowed WPCP staff to thicken sludge in the primary clarifiers.
- Rehabilitation/replacement of ferric chloride facilities:
 - These facilities had not been used since their construction, and plant staff indicated that they did not plan to use them in the foreseeable future.
- Rehabilitation/replacement of Aeration Blowers No. 7 and 8:
 - The City had completed related improvements during the final efforts associated with the WPCP Strategic Planning Report³.
- Rehabilitation/replacement of the photovoltaic (solar) system:
 - The City had requested that costs associated with replacement/repair of these facilities be excluded from the analysis at the time of its completion.

The costs for these project components were presented in the WPCP Strategic Planning Report⁴ (for reference only) but were not factored into the Condition-Driven Project Packages developed as part of that effort (discussed in Section 6.4). The need for these improvements should be reevaluated as facility uses continue to change.

6.4 Development of Condition-Driven Project Packages

The final analysis presented in the WPCP Strategic Planning Report⁵ included a list of condition-driven project packages based on the coupling of the near- and long-term condition-driven needs presented in Tables 6.1 and 6.2 for ease of delivery. This analysis is not updated herein for reasons of simplicity. The timing and scope of condition-driven project packages will need to be reevaluated as the City implements these improvements over time.

6.5 Summary of Condition-Driven Project Costs

The total estimated project cost for all near- and long term 2 condition-driven needs identified for Plant 2 is \$44.6 M (in December 2021 dollars). This estimated project cost is escalated to December 2026 dollars (\$55.6 M) for the connection payment calculation option presented in Chapter 1 with use of a projected average annual interest rate of 4.5 percent

² (Carollo Engineers, 2021).

³ (Carollo Engineers, 2021).

⁴ (Carollo Engineers, 2021).

⁵ (Carollo Engineers, 2021).

Chapter 7

FACILITY IMPROVEMENT RECOMMENDATIONS

Facility planning recommendations are summarized herein based on identified needs at the WPCP as related to projected capacity limitations, changing regulatory drivers, and observed condition deficiencies.

7.1 Summary of Capacity-Driven Projects

Several facility improvements are needed to increase the hydraulic and treatment capacity of the WPCP through the end of the planning period (2057).

The secondary treatment facilities will require significant improvement extending into the existing pond area south of the main WPCP treatment works area. Three options for expansion were evaluated (Table 7.1), with Option 3 costs carried through for planning purposes.

Table 7.1 Secondary Treatment Facility Expansion Options

Option 1	Option 2	Option 3
2 New Aeration Tanks (6 total)	3 New Aeration Tanks (7 total)	2 New Aeration Tanks (6 total)
4 New Secondary Clarifiers (7 total) ⁽¹⁾	2 New Secondary Clarifiers (5 total) ⁽²⁾	3 New Secondary Clarifiers (7 total) ⁽³⁾
Blower Upgrades	Blower Upgrades	Blower Upgrades
RAS/WAS Pumping Upgrades	RAS/WAS Pumping Upgrades	RAS/WAS Pumping Upgrades
Ancillary Upgrades	Ancillary Upgrades	Ancillary Upgrades

Notes:

(1) One (1) 100-ft diameter clarifier (near-term) and three (3) 100-ft diameter secondary clarifiers longer-term.

(2) One (1) 100-ft diameter clarifier (near-term) and one (1) 100-ft diameter secondary clarifier longer-term.

(3) One (1) 100-ft diameter clarifier (near-term) and two (2) 125-foot diameter secondary clarifiers longer-term.

Table 7.2 includes a summary of recommended projects based on anticipated capacity-driven facility needs through 2057, along with predicted timelines for implementation of each and planning level construction and project cost estimates (presented in December 2021 dollars).

Table 7.2 Summary of Capacity-Driven Facility Needs

Projected Timeline for Implementation	Project Description	Estimated Construction Cost ⁽¹⁾⁽²⁾	Estimated Project Cost ⁽¹⁾⁽³⁾
2028	Secondary Clarifier #6 ⁽⁴⁾ (fourth clarifier in Plant 2)	\$8,000,000	\$10,700,000
2032	Supplemental Carbon Project	\$300,000	\$400,000
2033	Chlorine Contact Basin	\$4,100,000	\$5,100,000
2033	Chemical Storage and Feed Facility Improvements (SHS and SBS)	\$1,300,000	\$1,600,000
2036	Southern Pond Improvements for Secondary Expansion	\$700,000	\$900,000
2036	Secondary Clarifier #7 ⁽⁵⁾ (fifth clarifier in Plant 2)	\$10,000,000	\$13,400,000
2036	RAS/WAS Pump Station and Electrical Building ⁽⁶⁾	\$1,300,000	\$1,600,000
2038	Parallel PE Force Main Improvements	\$800,000	\$1,100,000
2039	Secondary Clarifier #8 ⁽⁵⁾ (sixth clarifier in Plant 2)	\$10,000,000	\$13,400,000
2044	Aeration Tank #5 ⁽⁷⁾	\$11,700,000	\$15,600,000
2044	Blower and Electrical Building ⁽⁶⁾	\$5,000,000	\$6,300,000
2044	Standby Generator	\$1,200,000	\$1,500,000
2045	Primary Clarifier #4	\$3,700,000	\$5,000,000
2053	Aeration Tank #6 ⁽⁷⁾	\$11,700,000	\$15,600,000
2054	Primary Effluent Lift Station Improvements	\$1,700,000	\$2,100,000
2054	Bar Screen #3	\$500,000	\$600,000
Total Required Capital Investment		\$72,000,000	\$94,900,000⁽⁸⁾

Notes:

- (1) Costs are in December 2021 dollars based on ENR-CCI CCI of 12482.
- (2) Includes estimating contingency of 40% applied to total direct cost, general conditions and contractor overhead and profit contingencies at 18% of total direct cost (each), and local sales tax of 7.25% applied to half of the total direct cost.
- (3) Includes project cost factor of 35% for legal, administration, permitting, design, and engineering services during construction.
- (4) 100-foot diameter secondary clarifier.
- (5) 125-foot diameter secondary clarifier.
- (6) Based on Secondary Treatment Expansion Option 3 layout (Chapter 4).
- (7) With denitrification improvements (MLE).
- (8) Escalated to December 2026 dollars (\$118.3M) in Chapter 4 with use of a projected annual average interest rate of 4.5%.

7.1.1 Limitations of Capacity Analysis

The capacity of the existing WPCP facilities was evaluated against expected flows and loads projected over the planning horizon (through 2057), as calculated with an expected growth rate of 1.7 percent per year (Chapter 2). This growth rate value is consistent with the 2030 General Plan, but may prove inaccurate long-term due to the following:

- With a long planning period it is less likely that an assumed population growth rate of 1.7 percent will accurately represent the final population at build-out. The projection results in a population that is more than double the existing population in 35 years.
- Population and wastewater data collected in the baseline year of 2020 may be less representative than other years due to the impacts of the COVID-19 pandemic.

Additionally, there is some uncertainty with how the Paradise connection will impact projected flows and loads. Since a wastewater characterization of Paradise flows was unavailable, it was assumed that Paradise would produce flows with similar quality as Chico.

It is recommended that the City revisit the findings of this evaluation within the next 3 to 5 years to best prepare for future facility needs related to hydraulic and process capacity.

Last, the capacity analysis includes facility needs identified based on identified hydraulic and/or treatment limitations, without consideration of cost for facilities that may age out during the 35-year planning period. Additional cost may be incurred long-term for facilities deemed herein as having adequate capacity based on asset condition not addressed herein.

7.2 Summary of Regulatory-Driven Projects

Regulatory drivers for future facility upgrade needs were evaluated in detail in the WPCP Strategic Planning Report¹ with updated timing, facility sizing, and project costs presented herein (Chapter 5).

Table 7.3 includes a summary of recommended projects based on reasonably anticipated regulatory-driven facility needs through 2057, along with predicted timelines for implementation of each, and planning level project cost estimates (presented in December 2021 dollars).

Table 7.3 Summary of Regulatory-Driven Facility Needs

Projected Timeline for Implementation	Project Description	Estimated Construction Cost ⁽¹⁾⁽²⁾	Estimated Project Cost ⁽¹⁾⁽³⁾
2027	Emergency Effluent Bypass, Storage, and Return Improvements (NE Pond) ⁽⁴⁾	\$7,050,000	\$8,460,000
2032	Modified MLE process upgrades ⁽⁵⁾	\$3,620,000	\$4,350,000
2042	Tertiary Filtration Upgrades ⁽⁶⁾	\$16,830,000	\$22,710,000
2047	Alternate Disinfection ⁽⁷⁾	\$30,200,000	\$40,800,000
Total Required Capital Investment		\$57,700,000	\$76,320,000

Notes:

- (1) Costs are in December 2021 dollars based on ENR-CCI CCI of 12482.
- (2) Includes estimating contingency of 40% applied to total direct cost, general conditions and contractor overhead and profit contingencies at 18% of total direct cost (each), and local sales tax of 7.25% applied to half of the total direct cost.
- (3) Includes project cost factor of 35% for legal, administration, permitting, design, and engineering services during construction.
- (4) Includes pipeline between outfall box and Northeast Pond, a pump station for pump back to Headworks, and civil improvements to deepen the pond for 25 MG of storage.
- (5) In-basin improvements to existing aeration tanks in Plant 2.
- (6) Assumes cloth disk filtration, sized for peak flow at 39.6 mgd.
- (7) Assume UV disinfection, sized for peak flow of 39.6 mgd.

¹ (Carollo Engineers, 2021)

7.2.1 Limitations of Regulatory Analysis

Facility upgrade recommendations made herein are based on ongoing (and recent) coordination with the RWQCB and SWRCB, experience at similar facilities, and site-specific effluent and receiving water quality observations.

The regulatory climate is highly volatile, especially in California. This creates difficulty in fully predicting facility needs based on impending regulatory requirements over a long-term (35 year) planning horizon. For this reason, it is recommended that the City revisit the findings of this evaluation within the next 5 to 10 years to best prepare for future facility needs.

7.3 Summary of Condition-Driven Projects

Condition-driven needs at the WPCP were identified through an on-site, multi-discipline visual condition assessment of all facilities, including detailed mechanical, structural, and electrical/instrumentation and control inspections of each asset. The methods and findings of this effort are summarized in detail in the WPCP Strategic Planning Report².

Chapter 6 includes a high-level summary of condition-driven projects that resulted from this effort, escalated to December 2021 dollars. The originally projected project timing for the identified near-term and long-term condition-driven projects is summarized in Tables 7.4 and 7.5, respectively. Project costs have been escalated in both tables based on simple escalation between February 2021 and December 2021.

Near-and long term condition-driven project costs are further escalated to December 2026 dollars (\$55.6 M) with use of a projected average annual interest rate of 4.5 percent.

² (Carollo Engineers, 2021)

Table 7.4 Summary of Near-Term Condition-Driven Facility Needs

Process Area	Required Improvement	Timeline for Implementation ⁽¹⁾	Estimated Project Cost ⁽²⁾
Primary Treatment	Basin rehabilitation ⁽³⁾ Equipment replacement ⁽⁴⁾	< 5 years	\$3,680,000
Aeration	Equipment replacement ⁽⁵⁾	< 5 years	\$880,000
Secondary Treatment	Equipment replacement ⁽⁶⁾	< 5 years	\$980,000
Disinfection	Equipment replacement ⁽⁷⁾	< 5 years	\$840,000
Chemical Building	Equipment replacement ⁽⁸⁾	< 5 years	\$190,000
Solids Thickening	Equipment replacement ⁽⁹⁾	< 5 years	\$350,000
Solids Digestion	Equipment replacement ⁽¹⁰⁾	< 5 years	\$2,370,000
Solids Dewatering	Equipment replacement ⁽¹¹⁾	< 5 years	\$540,000
Plant Power Systems	Equipment replacement ⁽¹²⁾	< 5 years	\$10,000
Other Plant Systems	Equipment replacement ⁽¹³⁾	< 5 years	\$740,000
Total Near-Term Required Capital Investment			\$10,580,000

Notes:

- (1) These recommendations were originally made (as listed) in 2018.
- (2) Costs are escalated from those presented in the WPCP Strategic Planning Report based on December 2021 dollars using an ENR-CCI 20 Cities Index of 12482. Original cost estimating assumptions and limitations are discussed therein.
- (3) Includes concrete repair and rehabilitation, replacement of gates and actuators, all process instrumentation, and spot repair/rehabilitation of process piping.
- (4) Includes replacement of sludge collector motor and chains for Primary Clarifier Nos. 1 and 2, pit pumps for Primary Clarifier Nos. 1 and 2, primary effluent pump motors (pumps No. 2 and 3), replacement of PLC-H, and ancillary items.
- (5) Includes replacement of Blower No. 7, air diffuser and air flow meters in Aeration Basin Nos. 3 and 4, PLC-B, and ancillary items.
- (6) Includes replacement of sludge collectors for Secondary Clarifier Nos. 3 and 4, replacement of MCC-EP-1, MCC-P1, and PLC-R, and ancillary items.
- (7) Includes replacement of flash mixers for Chlorine Contact Basin Nos. 3 and 4, gates and actuators, flow meters, sampling pumps, PLC-C, and ancillary items.
- (8) Includes replacement of CSS Pump Nos. 1 and 2, SBH Recirculation Pump No. 1, SHS Pump No. 1, PLC-C, and ancillary items.
- (9) Includes replacement of Recycle Pressurization Pump Nos. 1-4, air compressors for DAFT Nos. 1 and 2, polymer feed system, MCC-EP5, PLC-B-1/02, and miscellaneous items.
- (10) Includes improvements to Boiler Building No. 2 and replacement of Sludge Heater Nos. 1-3, digester gas flow meters, PLC-D, and ancillary items.
- (11) Includes replacement of Screw Conveyor No. 1, solids grinder, miscellaneous exhaust/supply fans, flow meters, and unit heaters, PLC-B2-1/02, and ancillary items.
- (12) Includes replacement of LCP-PCP-47.
- (13) Includes replacement of Deep Well Pump Nos. 1 and 2, MCC-PC/EP-2, and ancillary items.

Table 7.5 Summary of Long-Term Condition-Driven Facility Needs

Process Area	Required Improvement	Timeline for Implementation ⁽¹⁾	Estimated Project Cost ⁽²⁾
Headworks	Equipment rehabilitation/replacement ⁽³⁾	2029 - 2039	\$3,180,000
Primary Treatment	Equipment replacement ⁽⁴⁾	2025 - 2039	\$4,160,000
Aeration	Equipment replacement ⁽⁵⁾	2027 - 2039	\$1,900,000
Secondary Treatment	Equipment replacement ⁽⁶⁾	2027 - 2039	\$2,390,000
Disinfection	Equipment replacement ⁽⁷⁾	2027 - 2039	\$1,080,000
Chemical Building	Equipment replacement ⁽⁸⁾	2029 - 2038	\$510,000
Solids Thickening	Equipment replacement ⁽⁹⁾	2027 - 2039	\$1,210,000
Solids Digestion	Equipment replacement ⁽¹⁰⁾	2027 - 2040	\$6,210,000
Solids Dewatering	Equipment replacement ⁽¹¹⁾	2027 - 2039	\$5,790,000
Plant Power Systems	Equipment replacement ⁽¹²⁾	2027 - 2039	\$7,210,000
Other Plant Systems	Equipment replacement ⁽¹³⁾	2027 - 2039	\$420,000
Total Long-Term Required Capital Investment			\$34,060,000

Notes:

- (1) These recommendations were originally made (as listed) in 2018.
- (2) Costs are escalated from those presented in the WPCP Strategic Planning Report based on December 2021 dollars using an ENR-CCI 20 Cities Index of 12482. Original cost estimating assumptions and limitations are discussed therein.
- (3) Includes replacement of major mechanical equipment items (shaftless screw conveyor, mechanical bar screens, screenings washer/compactors, vortex grit chamber drives, grit cyclone separators, ferric facility pumps biofilter fans, grit basement exhaust and supply fans, flow meters/transmitters, sump pumps, analyzers, samplers, etc.) (in 2029); and replacement of grit pumps, channel gates, and MCC-P14 (in 2039).
- (4) Includes rehabilitation of Primary Clarifier No. 3 (motor and chains, sludge collector drives, chains, etc), replacement of Primary Effluent Pumps Nos. 1-3 (with new VFDs), and ancillary items (in 2027); replacement of MCC-EP7 and PLC-X (in 2029); miscellaneous items (2030 - 2036); and replacement of Primary Effluent Pump No. 4 and MCC-P13 (in 2039).
- (5) Includes replacement of tank inlet/outlet gates and MCC-P8 (in 2027); DO meters (in 2028); air diffusers and flow meters for Aeration Basin Nos. 5 and 6, exhaust and supply fans for Blower Building No. 2, and PLC-BB (in 2029); air inlet and blow off valves (in 2032); miscellaneous items (2034-2036); and Blower No. 8, and inlet and outlet gates for Aeration Basin Nos. 5 and 6 (in 2039).
- (6) Includes replacement of sludge collector drive for Secondary Clarifier No. 3, RAS Pump Nos. 4-7, MCC-P11A, and SWGP-1 (in 2027); MCC-P11 and PLC-RR (in 2029); miscellaneous flow meters and heat pumps (in 2036); and the sludge collector drive for Secondary Clarifier No. 5, RAS Pump No. 9, and Secondary Scum Pump No. 5 (in 2039).
- (7) Includes replacement of sluice gates (in 2027), miscellaneous flow meters, analyzers, and sample pumps (2028-2035), and the hydraulic power unit and sluice gates (in 2039).
- (8) Includes replacement of MCC-P12, SBS recirculation Pump No. 2, and miscellaneous heat pumps, unit heaters, exhaust fans, and instrumentation (in 2029); and replacement of SBS Pump Nos. 1 and 2 and SHS Pumps 2-4 (in 2038).
- (9) Includes replacement of DAFT No. 2 collector drive, TWAS Pump Nos. 1-4, Thickened Sludge Grinder Nos. 1 and 2, instrumentation for DAFT Nos. 1 and 2, and MCC-P13 (in 2029); DAFT No. 1 collector drive (in 2032); and Thickened Sludge Pump Nos. 1 and 2 (in 2039).
- (10) Includes replacement of Digester No. 3, most digester transfer/recirculation pumps and Sludge Mixing Pump Nos. 1-3 (in 2027); MCC-P15, MCC-P9, PLC-X, and miscellaneous items (in 2029); miscellaneous flow meters, inlet valves (2030-2036); and Digester Transfer Pump No. 2, Sludge Mixing Pump No. 4, Digester Recirculation Pump No. 3, and Hot Water Loop Pump Nos. 1-3 (in 2039).
- (11) Includes replacement of Centrifuge No. 1 and miscellaneous control and starter panels (in 2027); Screw Conveyor Nos. 2 and 3, Polymer Mixing Pump Nos. 1-2, Polymer Blending Pump Nos. 1-2, and MCC-P10 (in 2029); miscellaneous items (2030-2037); and Centrifuge No. 2, Centrifuge Feed Pump Nos. 1-2, and ancillary items (in 2039).
- (12) Includes replacement of solar power system, Switchboard-P2, Transformer No. 1, and Standby Generator No. 2 Control Panel (in 2027); Substation No. 1, Panel-P9A, and miscellaneous electrical items (in 2029); the cogeneration unit (in 2034); Standby Generator No. 2 and the synchronizer panel for Generator Nos. 1-2 (in 2037); and the cogeneration hot water loop and control panels for Standby Generator No. 3 and 4 (in 2039).
- (13) Includes replacement of 3W Pump Nos. 1-4 and main hot water pumps (in 2027); miscellaneous items (2029-2032), and 3W Pump No. 5 (in 2039).

7.3.1 Limitations of Condition Analysis

The assessment of condition-driven facility needs is based on observations from 2018, with initial project scheduled for implementation starting in 2021, though 2040 (the previous planning period). Project costs were escalated for this planning effort, but projected timelines were not adjusted. Additionally, the City will encounter additional rehabilitation and/or replacement needs within the new planning period (that extends through 2057) that have not been identified herein. It is recommended that the City conduct an updated analysis to determine long-term facility needs as near-term condition-driven projects are completed.

7.4 Capital Improvement Project Summary

Capital need projections are included herein to supplement the City's sewer rate study, providing sustainable budgets for current and projected WPCP needs through updated sewer fees. All recommended projects are summarized in Table 7.6.

Table 7.6 Summary of Recommended Project and Project Cost

Projected Timeline for Implementation	Capacity Improvements	Project Driver	Estimated Project Cost ⁽¹⁾
2021	Aeration and Primary Treatment Upgrades Recommended by 2023 ⁽²⁾	Condition	\$1,870,000
2022	Disinfection, Chemical Building, Solids Thickening and Dewatering, Plant Power Systems, and Other Plant Systems Upgrades Recommended by 2023 ⁽²⁾	Condition	\$2,670,000
2023	Solids Digestion Upgrades Recommended by 2023 ⁽²⁾	Condition	\$2,370,000
2025	Primary Treatment Upgrades Recommended by 2025 ⁽²⁾	Condition	\$3,680,000
2025	Recycled Water Feasibility Study	Strategic	\$530,000
2027	Emergency Effluent Bypass, Storage, and Return Improvements	Regulatory	\$8,460,000
2027	Condition Driven Upgrades Recommended in 2027 ⁽²⁾	Condition	\$7,640,000
2028	Secondary Clarifier #6 ⁽³⁾ (fourth clarifier in Plant 2)	Capacity	\$10,700,000
2028	Condition Driven Upgrades Recommended in 2028 ⁽²⁾	Condition	\$3,240,000
2029	Condition Driven Upgrades Recommended in 2029 ⁽²⁾	Condition	\$5,390,000
2032	Modified MLE process upgrades	Regulatory	\$4,350,000
2033	Condition Driven Upgrades Recommended in 2033 ⁽²⁾	Condition	\$3,520,000
2032	Supplemental Carbon Project	Capacity	\$400,000
2033	Chlorine Contact Basin	Capacity	\$5,100,000
2033	Chemical Storage and Feed Facility Improvements (SHS and SBS)	Capacity	\$1,600,000
2036	Southern Pond Improvements for Secondary Expansion	Capacity	\$900,000
2036	Secondary Clarifier #7 ⁽⁴⁾ (fifth clarifier in Plant 2)	Capacity	\$13,400,000
2036	RAS/WAS Pump Station and Electrical Building ⁽⁵⁾	Capacity	\$1,600,000
2038	Parallel Primary Effluent Force Main Improvements	Capacity	\$1,100,000
2039	Secondary Clarifier #8 ⁽⁴⁾ (sixth clarifier in Plant 2)	Capacity	\$13,400,000

Projected Timeline for Implementation	Capacity Improvements	Project Driver	Estimated Project Cost ⁽¹⁾
2039	Condition Driven Upgrades Recommended in 2039 ⁽²⁾	Condition	\$10,460,000
2040	Anaerobic Digester 3 ⁽²⁾	Condition	\$3,800,000
2042	Tertiary filtration ⁽⁶⁾	Regulatory	\$22,710,000
2044	Aeration Tank #5 ⁽⁷⁾	Capacity	\$15,600,000
2044	Blower and Electrical Building ⁽⁵⁾	Capacity	\$6,300,000
2044	Standby Generator	Capacity	\$1,500,000
2045	Primary Clarifier #4	Capacity	\$5,000,000
2047	Alternate Disinfection ⁽⁶⁾	Regulatory	\$40,800,000
2053	Aeration Tank #6 ⁽⁷⁾	Capacity	\$15,600,000
2054	Primary Effluent Lift Station Improvements	Capacity	\$2,100,000
2054	Bar Screen #3	Capacity	\$600,000
Total Required Capital Investment			\$216,360,000

Notes:

- (1) Costs are in December 2021 dollars based on ENR-CCI CCI of 12482.
- (2) Refer to Chapter 6 for condition-driven project specific details.
- (3) 100-foot diameter secondary clarifier.
- (4) 125-foot diameter secondary clarifier.
- (5) Based on Secondary Treatment Expansion Option 3 layout (Chapter 4).
- (6) Sized for peak flow of 39.6 mgd.
- (7) With denitrification improvements (MLE).

Figures 7.1 and 7.2 depict the capital investment needs per category (condition, capacity, and regulatory-driven facility needs) and total projected annual spending needs over the planning horizon (through 2057), respectively.

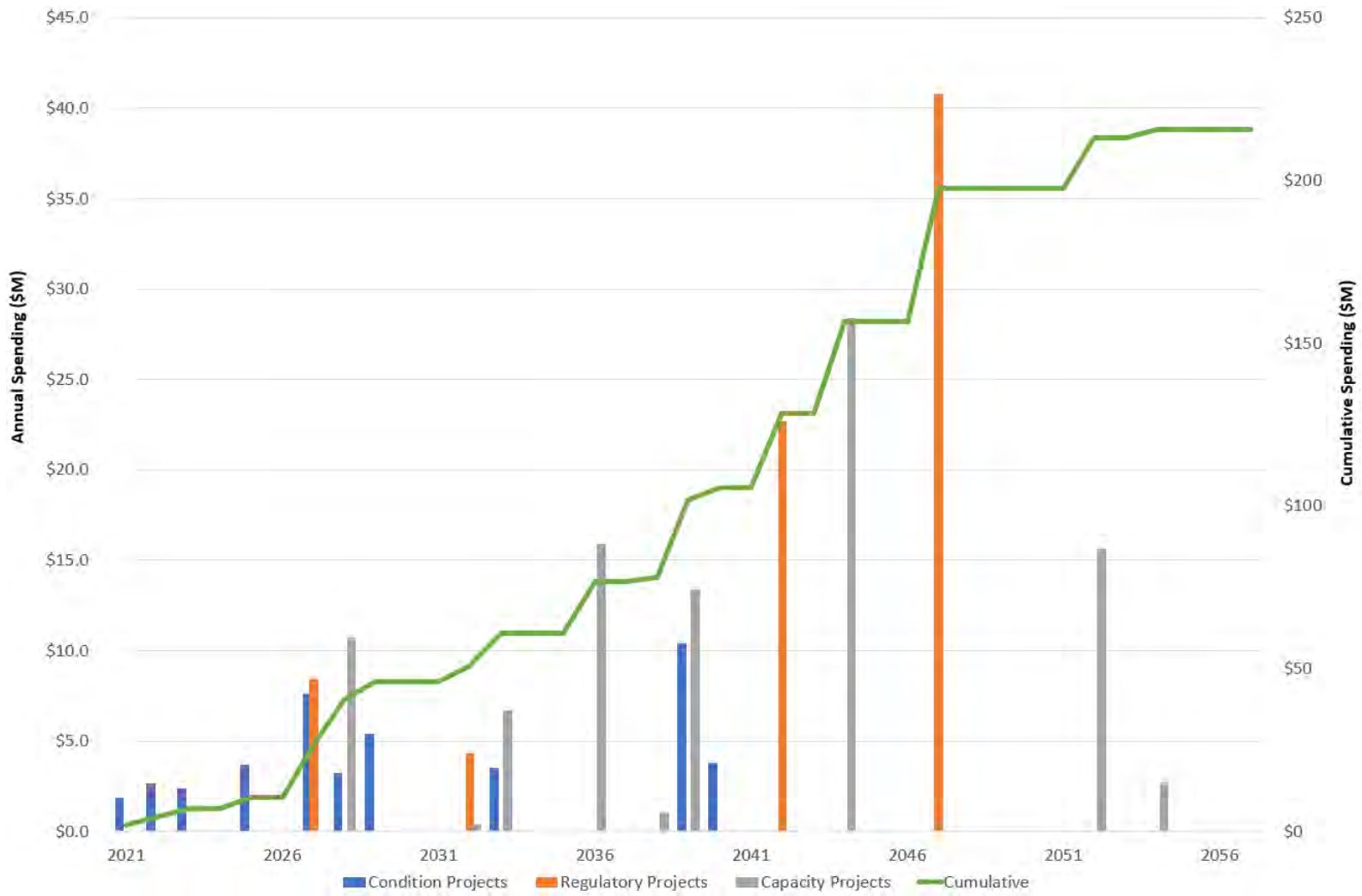

Figure 7.1 Projected Capital Investment by Spending Category

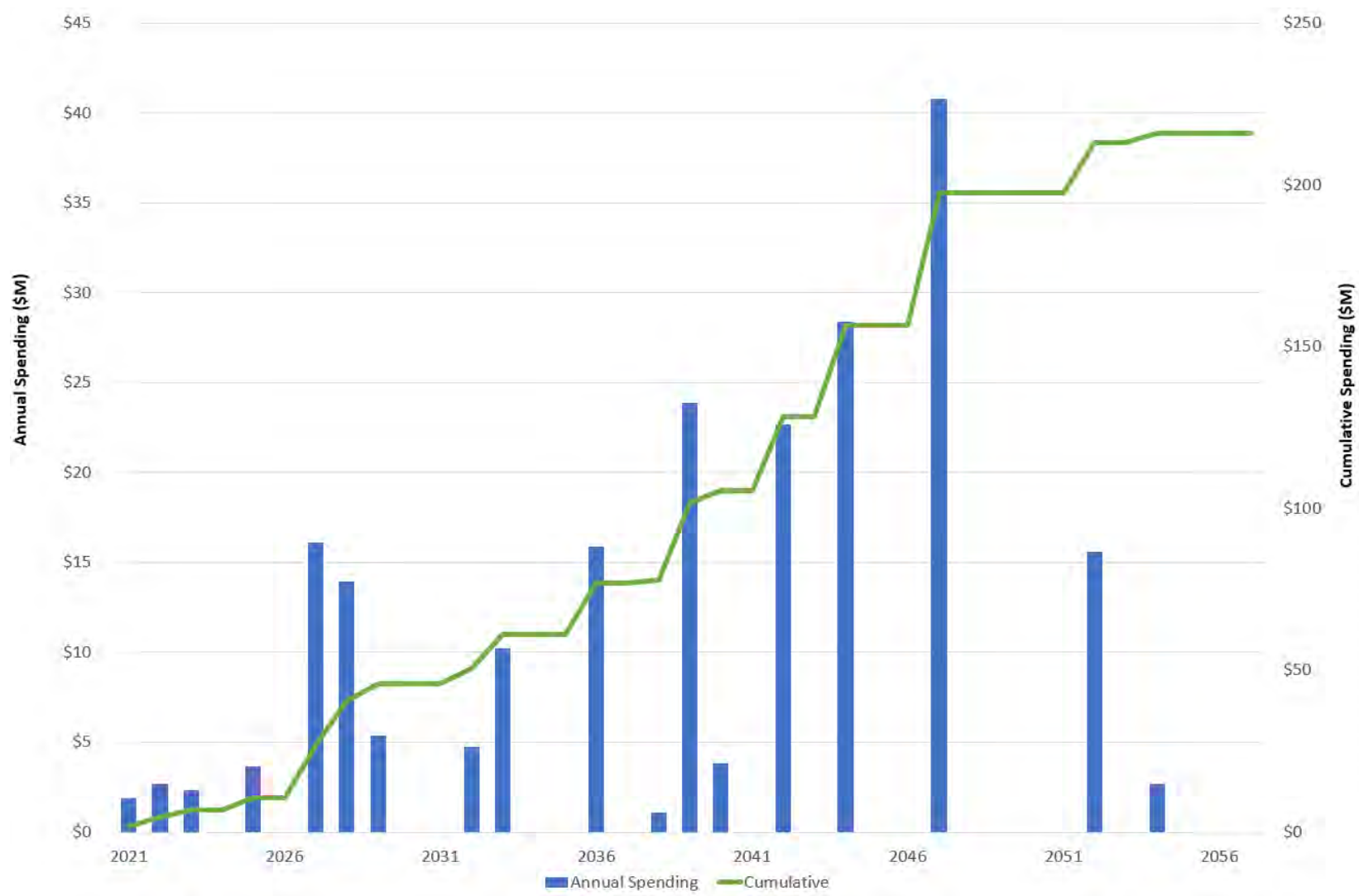

Figure 7.2 Total Annual Capital Spending through Planning Horizon

-This Page Intentionally Left Blank-

Appendix A
COST ESTIMATES

-This Page Intentionally Left Blank-

BASIS OF COST ESTIMATES

Construction costs included in this report were estimated using unit costs developed from previous construction contracts, estimating guides, unit prices, and construction costs of similar facilities and process configuration at other locations. Using these sources, adjusted capital costs were developed.

Construction costs have historically escalated with time. This trend is expected to continue in the future. To record these trends in rising costs, several indices have been established for various fields of construction. The most commonly used standard barometer of construction cost changes is the Engineering News Report's Construction Cost Index (ENR-CCI). Capital costs for the alternative analysis are based on the December 2021 20-Cities ENR-CCI of 12482, and the R.S. Means Location Factor for Redding, CA, of 1.185 (an index which represents the relative geographic difference in materials pricing and cost of labor between individual cities as compared to a standard factor). Redding currently represents the closest and most appropriate location factor for estimating construction costs in Chico.

Costs within this section were developed following the AACE International Recommended Practice No. 18R-97 for a Class 5 estimate level. According to AACE International, a "Class 5 Estimate" is defined as an estimate used for screening or feasibility studies during 0 to 2 percent project completion with an expected accuracy of +50 percent to -30 percent in relation to the actual completed project cost.

Table 1 includes a summary of cost estimating factors and contingencies used in the preparation of each cost estimate.

Table A.1 Cost Estimating Factors and Contingencies

Item	Value
Estimating Contingency	40%
Contractor Overhead and Profit	18%
General Conditions	18%
Sales Tax	7.250%
Project Cost Factor	35%
ENR-CCI ⁽¹⁾	12482
Location Factor ⁽²⁾	1.185

Notes:

(1) December 2021 ENR-CCI 20Cities.

(2) Location Factor for Redding, CA.

CAPACITY-DRIVEN PROJECT COST ESTIMATES

Table A.2 Headworks Bar Screen Project Cost Estimate

Description	Qty	Unit	Unit Cost	Total
Equipment ⁽¹⁾	1	LS	\$225,000	\$225,000
Installation	25	%	\$56,250	\$56,000
El&C	20	%	\$45,000	\$45,000
Total Direct Costs				\$326,000
Contingency		40%		\$49,000
<i>Subtotal</i>				<i>\$375,000</i>
Contractor Overhead & Profit		18%		\$68,000
General Conditions		18%		\$68,000
Sales Tax on 50%		7.25%		\$14,000
Total Construction Cost				\$500,000
Project Cost Factor		35%		\$79,000
Total Project Cost⁽²⁾				\$600,000

Notes:

(1) Fine screen with 18 MGD capacity, matching existing screens.

(2) Costs are in December 2021 dollars based on ENR-CCI CCI of 12482.

Table A.3 Primary Clarifier Project Cost Estimate

Description	Qty	Unit	Unit Cost	Total
Primary Clarifier ⁽¹⁾	38,000	ft ³	\$38	\$1,459,000
Site Work	1	LS	\$95,000	\$95,000
Valving/Mechanical	1	LS	\$58,000	\$58,000
Yard Piping	1	LS	\$117,000	\$117,000
El&C	1	LS	\$168,000	\$168,000
Total Direct Costs				\$1,897,000
Contingency		40%		\$759,000
<i>Subtotal</i>				<i>\$2,656,000</i>
Contractor Overhead & Profit		18%		\$478,000
General Conditions		18%		\$478,000
Sales Tax on 50%		7.25%		\$96,000
Total Construction Cost				\$3,700,000
Project Cost Factor		35%		\$1,298,000
Total Project Cost⁽²⁾				\$5,000,000

Notes:

(1) Estimated from cost curve from construction bid tabs for primary clarifiers.

(2) Costs are in December 2021 dollars based on ENR-CCI CCI of 12482.

Table A.4 Aeration Tank Project Cost Estimate

Description	Qty	Unit	Unit Cost	Total
Aeration Tank ⁽¹⁾	176,600	ft ³	\$24	\$4,238,000
Site Work	1	LS	\$275,000	\$275,000
Valving/Mechanical	1	LS	\$170,000	\$170,000
Yard Piping	1	LS	\$424,000	\$424,000
EI&C	1	LS	\$572,000	\$572,000
Total Direct Costs				\$5,509,000
Contingency		40%		\$2,204,000
<i>Subtotal</i>				<i>\$7,713,000</i>
Contractor Overhead & Profit		18%		\$1,388,000
General Conditions		18%		\$1,388,000
Sales Tax on 50%		7.25%		\$280,000
Total Construction Cost				\$10,800,000
Project Cost Factor		35%		\$3,769,000
Total Project Cost⁽²⁾				\$14,500,000

Notes:

(1) Estimated from cost curve from construction bid tabs for aeration tanks.

(2) Costs are in December 2021 dollars based on ENR-CCI CCI of 12482.

Table A.5 Supplemental Carbon Project Cost Estimate

Description	Qty	Unit	Unit Cost	Total
Carbon Storage Tote/Rack	1	LS	\$85,000	\$80,000
Pumping Equipment			\$25,000	\$25,000
Installation	25	%	\$27,500	\$28,000
EI&C	20	%	\$22,000	\$22,000
Total Direct Costs				\$160,000
Contingency		40%		\$64,000
<i>Subtotal</i>				<i>\$223,000</i>
Contractor Overhead & Profit		18%		\$40,000
General Conditions		18%		\$40,000
Sales Tax on 50%		7.25%		\$8,000
Total Construction Cost				\$300,000
Project Cost Factor		35%		\$78,000
Total Project Cost⁽¹⁾				\$400,000

Notes:

(1) Costs are in December 2021 dollars based on ENR-CCI CCI of 12482.

Table A.6 Secondary Clarifier Project Cost Estimate

Description	Qty	Unit	Unit Cost	Total
Secondary Clarifier ⁽¹⁾	110,000	ft ³	\$28	\$3,132,000
Site Work	1	LS	\$204,000	\$204,000
Yard Piping			\$313,000	\$313,000
EI&C	1	LS	\$423,000	\$423,000
Total Direct Costs				\$4,072,000
Contingency		40%		\$1,629,000
<i>Subtotal</i>				<i>\$5,700,000</i>
Contractor Overhead & Profit		18%		\$1,026,000
General Conditions		18%		\$1,026,000
Sales Tax on 50%		7.25%		\$207,000
Total Construction Cost				\$8,000,000
Project Cost Factor		35%		\$2,786,000
Total Project Cost⁽³⁾				\$10,700,000⁽³⁾

Notes:

- (1) Estimated from cost curve from construction bid tabs for secondary clarifiers.
- (2) Costs are in December 2021 dollars based on ENR-CCI CCI of 12482.
- (3) Estimated Project Cost is for 100-ft diameter secondary clarifier. The estimated project cost for a 125-ft diameter secondary clarifier (Option 3) is \$13.4M.

Table A.7 RAS/WAS Pump Station and Electrical Building Project Cost Estimate⁽¹⁾

Description	Qty	Unit	Unit Cost	Total
RAS Pumps	3	EA	\$45,000	\$135,000
WAS Pumps	2	EA	\$20,000	\$40,000
Piping/Valving	25	%	\$43,750	\$44,000
Electrical Building	1	LS	\$200,000	\$200,000
Installation	25	%	\$104,700	\$105,000
EI&C	20	%	\$83,750	\$84,000
Total Direct Costs				\$607,000
Contingency		40%		\$243,000
<i>Subtotal</i>				<i>\$850,000</i>
Contractor Overhead & Profit		18%		\$183,000
General Conditions		18%		\$183,000
Sales Tax on 50%		7.25%		\$37,000
Total Construction Cost				\$1,300,000
Project Cost Factor		35%		\$313,000
Total Project Cost⁽²⁾				\$1,600,000⁽³⁾

Notes:

- (1) Based on Option 3 Secondary Treatment Expansion Layout.
- (2) Costs are in December 2021 dollars based on ENR-CCI CCI of 12482.
- (3) Estimated Project Cost for Option 1 and Option 2 Secondary Treatment Expansion Layout is \$1.8 and \$1.4 million, respectively.

Table A.8 Blower and Electrical Building Project Cost Estimate⁽¹⁾

Description	Qty	Unit	Unit Cost	Total
Blower Building	1	EA	\$350,000	\$350,000
Blowers	3	EA	\$300,000	\$900,000
Air Header Piping	150	LF	\$250	\$38,000
Valving/Mechanical	15	%	\$193,100	\$193,000
Electrical Gear	1	LS	\$300,000	\$300,000
Installation	25	%	\$445,200	\$445,000
El&C	20	%	\$356,100	\$356,000
Total Direct Costs				\$2,582,000
Contingency		40%		\$1,033,000
<i>Subtotal</i>				<i>\$3,615,000</i>
Contractor Overhead & Profit		18%		\$651,000
General Conditions		18%		\$651,000
Sales Tax on 50%		7.25%		\$131,000
Total Construction Cost				\$5,000,000
Project Cost Factor		35%		\$1,262,000
Total Project Cost⁽²⁾				\$6,300,000⁽³⁾

Notes:

(1) Based on Option 3 Secondary Treatment Expansion Layout.

(2) Costs are in December 2021 dollars based on ENR-CCI CCI of 12482.

(3) Estimated Project Cost for Option 1 and Option 2 Secondary Treatment Expansion Layout is \$6.3 (same as Option 3) and \$7.2 million, respectively.

Table A.9 Southern Pond Improvements for Secondary Expansion Project Cost Estimate

Description	Qty	Unit	Unit Cost	Total
Effluent Line to Southwest Pond	500	FT	\$250,000	\$125,000
Pond Inlet Structures	2	EA	\$60,000	\$120,000
Installation	25	%	\$68,750	\$61,000
El&C	20	%	\$55,000	\$49,000
Total Direct Costs				\$355,000
Contingency		40%		\$142,000
<i>Subtotal</i>				<i>\$497,000</i>
Contractor Overhead & Profit		18%		\$90,000
General Conditions		18%		\$90,000
Sales Tax on 50%		7.25%		\$18,000
Total Construction Cost				\$700,000
Project Cost Factor		35%		\$174,000
Total Project Cost⁽¹⁾				\$900,000

Notes:

(1) Costs are in December 2021 dollars based on ENR-CCI CCI of 12482.

Table A.10 Standby Generator Project Cost Estimate

Description	Qty	Unit	Unit Cost	Total
Standby Generator	1	EA	\$250,000	\$250,000
Structural	1	EA	\$75,000	\$75,000
Fuel Storage	1	EA	\$50,000	\$50,000
Valving/Mechanical	15	%	\$56,300	\$56,000
Installation	25	%	\$107,800	\$108,000
EI&C	20	%	\$86,300	\$86,000
Total Direct Costs				\$625,000
Contingency		40%		\$250,000
<i>Subtotal</i>				<i>\$875,000</i>
Contractor Overhead & Profit		18%		\$158,000
General Conditions		18%		\$158,000
Sales Tax on 50%		7.25%		\$32,000
Total Construction Cost				\$1,200,000
Project Cost Factor		35%		\$306,000
Total Project Cost⁽¹⁾				\$1,500,000

Notes:

(1) Costs are in December 2021 dollars based on ENR-CCI CCI of 12482.

Table A.11 Chlorine Contact Basin Project Cost Estimate

Description	Qty	Unit	Unit Cost	Total
Chlorine Contact Basin	1	EA	\$950,000	\$3,132,000
Inlet Basin Modifications	1	EA	\$100,000	\$100,000
Chemical mixing/valves/mechanical	15	%	\$157,500	\$158,000
Site Work	15	%	\$181,200	\$181,000
Installation	25	%	\$347,200	\$347,000
EI&C	20	%	\$241,500	\$242,000
Bypass Pumping	1	LS	\$100,000	\$100,000
Total Direct Costs				\$2,077,000
Contingency		40%		\$831,000
<i>Subtotal</i>				<i>\$2,908,000</i>
Contractor Overhead & Profit		18%		\$523,000
General Conditions		18%		\$523,000
Sales Tax on 50%		7.25%		\$105,000
Total Construction Cost				\$4,100,000
Project Cost Factor		35%		\$1,015,000
Total Project Cost⁽¹⁾				\$5,100,000

Notes:

(1) Costs are in December 2021 dollars based on ENR-CCI CCI of 12482.

Table A.12 SHS/SBS Storage and Feed Facility and Outfall Box Modification Project Cost Estimate

Description	Qty	Unit	Unit Cost	Total
Chemical Building Modifications	1	EA	\$100,000	\$100,000
Chemical Tanks	2	EA	\$75,000	\$150,000
Chemical Pumps	2	EA	\$15,000	\$30,000
Outfall Box Modifications	1	EA	\$100,000	\$100,000
Piping/valving/mechanical	20	%	\$76,000	\$76,000
Installation	25	%	\$114,000	\$114,000
El&C	20	%	\$91,200	\$92,000
Total Direct Costs				\$661,000
Contingency		40%		\$264,000
<i>Subtotal</i>				<i>\$926,000</i>
Contractor Overhead & Profit		18%		\$167,000
General Conditions		18%		\$167,000
Sales Tax on 50%		7.25%		\$34,000
Total Construction Cost				\$1,300,000
Project Cost Factor		35%		\$323,000
Total Project Cost⁽¹⁾				\$1,600,000

Notes:

(1) Costs are in December 2021 dollars based on ENR-CCI CCI of 12482.

Table A.13 Primary Effluent Lift Station Improvements Project Cost Estimate

Description	Qty	Unit	Unit Cost	Total
Structure Modifications	1	EA	\$250,000	\$250,000
PE Pump	1	EA	\$150,000	\$150,000
Valving/Mechanical	15	%	\$60,000	\$60,000
Installation	25	%	\$115,000	\$115,000
El&C	20	%	\$92,000	\$92,000
Bypass Pumping	1	LS	\$250,000	\$250,000
Total Direct Costs				\$917,000
Contingency		40%		\$347,000
<i>Subtotal</i>				<i>\$1,214,000</i>
Contractor Overhead & Profit		18%		\$218,000
General Conditions		18%		\$218,000
Sales Tax on 50%		7.25%		\$44,000
Total Construction Cost				\$1,700,000
Project Cost Factor		35%		\$424,000
Total Project Cost⁽¹⁾				\$2,100,000

Notes:

(1) Costs are in December 2021 dollars based on ENR-CCI CCI of 12482.

Table A.14 Primary Effluent Force Main Project Cost Estimate

Description	Qty	Unit	Unit Cost	Total
Force Main between PELS and ATs	600	FT	\$450	\$270,000
Installation ⁽¹⁾	40	%	\$108,000	\$108,000
EI&C	20	%	\$54,000	\$54,000
Total Direct Costs				\$432,000
Contingency		40%		\$173,000
<i>Subtotal</i>				<i>\$605,000</i>
Contractor Overhead & Profit		18%		\$109,000
General Conditions		18%		\$109,000
Sales Tax on 50%		7.25%		\$22,000
Total Construction Cost				\$800,000
Project Cost Factor		35%		\$211,000
Total Project Cost⁽¹⁾				\$1,100,000

Notes:

(1) Difficult installation.

(2) Costs are in December 2021 dollars based on ENR-CCI CCI of 12482.

REGULATORY-DRIVEN PROJECT COST ESTIMATES

Table A.15 MLE Project Cost Estimate

Description	Qty	Unit	Unit Cost	Total
MLE Pump	6	EA	\$116,700	\$700,000
Submersible Mixer	14	EA	\$59,400	\$832,000
Valving/Mechanical	15	%	\$229,800	\$230,000
Installation	15	%	\$264,200	\$264,000
EI&C	15	%	\$264,200	\$264,000
Total Direct Costs				\$2,290,000
Contingency		40%		\$916,000
<i>Subtotal</i>				<i>\$3,206,000</i>
Contractor Overhead & Profit		18%		\$158,000
General Conditions		18%		\$158,000
Sales Tax on 50%		7.25%		\$32,000
Total Construction Cost				\$3,600,000
Project Cost Factor		35%		\$888,000
Total Project Cost⁽¹⁾				\$4,400,000⁽²⁾

Notes:

(1) Costs are in December 2021 dollars based on ENR-CCI CCI of 12482.

(2) Total project cost is for retrofit of existing Aeration Tanks 3-6. An "MLE Addition" cost of \$1.1M is extended to each AT that is included in the various Secondary Treatment Expansion Options.

Table A.16 Emergency Bypass, Storage, and Return Improvements

Description	Qty	Unit	Unit Cost	Total
Site Work	1	LS	\$1,440,000	\$1,440,000
Pump Station and Pipeline	1	LS	\$1,600,000	\$1,600,000
Bypass Pumping	1	LS	\$425,000	\$425,000
Total Direct Costs				\$3,456,000
Contingency		40%		\$1,386,000
<i>Subtotal</i>				<i>\$4,851,000</i>
Contractor Overhead & Profit		18%		\$873,000
General Conditions		18%		\$873,000
Sales Tax on 50%		7.25%		\$176,000
Total Construction Cost				\$6,800,000
Project Cost Factor		35%		\$1,693,000
Total Project Cost⁽¹⁾				\$8,500,000

Notes:

(1) Costs are in December 2021 dollars based on ENR-CCI CCI of 12482.

Table A.17 Cloth Disk Filter Project Cost Estimate

Description	Qty	Unit	Unit Cost	Total
Equipment ⁽¹⁾	1	LS	\$2,957,000	\$2,957,000
Concrete	1	LS	\$690,000	\$690,000
Piping	1	LS	\$1,331,000	\$1,331,000
E&IC	1	LS	\$1,183,000	\$1,183,000
Site Work	1	LS	\$616,000	\$616,000
Yard Piping	1	LS	\$616,000	\$616,000
Tertiary Lift Station	1	LS	\$1,200,000	\$1,214,000
Total Direct Cost				\$8,607,000
Estimating Contingency	40%			\$3,443,000
			<i>Subtotal</i>	\$12,050,000
Contractor Overhead & Profit	18%			\$2,169,000
General Conditions	18%			\$2,169,000
Sales Tax on 50%	7.25%			\$437,000
Total Construction Cost				\$16,825,000
Project Cost Factor	35%			\$5,889,000
Total Project Cost⁽²⁾				\$22,714,000

Notes:

(1) Equipment quote from vendor, with additional 20 percent added for installation.

(2) Costs are in December 2021 dollars based on ENR-CCI CCI of 12482.

Table A.18 UV Capital Project Cost Estimate

Description	Qty	Unit	Unit Cost	Total
UV Equipment	1	LS	\$6,207,000	\$6,207,000
Site Work	1	LS	\$621,000	\$621,000
Structural	1	LS	\$3,104,000	\$3,104,000
Electrical, Instrumentation, and Controls	1	LS	\$3,725,000	\$3,725,000
Electrical Building	1	LS	\$260,000	\$260,000
Piping	1	LS	\$1,552,000	\$1,552,000
Total Direct Costs				\$15,469,000
Contingency		40%		\$6,188,000
			<i>Subtotal</i>	\$21,657,000
Contractor Overhead & Profit		18%		\$3,898,000
General Conditions		18%		\$3,898,000
Sales Tax on 50%		7%		\$785,000
Total Construction Cost				\$30,200,000
Project Cost Factor		35%		\$10,538,000
Total Project Cost				\$40,800,000

Notes:

(1) Costs are in December 2021 dollars based on ENR-CCI CCI of 12482.

Appendix B
DAILY DATA

-This Page Intentionally Left Blank-

Date	Butte Break?	CSU Break?	Precip?	Min Influent Flow, mgd	Max Influent Flow, mgd	Avg Influent Flow, mgd	Min % of Avg	Min % of Max	Avg % of Max	Flow Outlier Type	Diurnal Peak Factor (DPF)	30-d Avg of Avg Flow, mgd	7-d Avg of Avg Flow, mgd	Influent TSS Conc., mg/L	Influent BOD Conc., mg/L	BOD/TSS Ratio	Influent NH3-N Conc., mg/L	Avg Inf TSS Load, ppd	Avg Inf BOD Load, ppd	Avg Inf NH3 Load, ppd	Load Outlier Type	30-d Avg of TSS Load, ppd	30-d Avg of BOD Load, ppd	30-d Avg of NH3-N Load, ppd	non-SN TSS Load, ppd	non-SN BOD Load, ppd	non-SN NH3 Load, ppd	30-d Avg of non-SN TSS Load, ppd	30-d Avg of non-SN BOD Load, ppd	30-d Avg of non-SN NH3-N Load, ppd
5/1/2009	FALSE	FALSE		3.77	9.96	7.78	48%	38%	78%		1.28			237.00	202.00	0.85		15,374	13,103					15,374	13,103					
5/2/2009	FALSE	FALSE		4.01	11.03	8.15	49%	36%	74%		1.35																			
5/3/2009	FALSE	FALSE		4.22	11.01	7.99	53%	38%	73%		1.38																			
5/4/2009	FALSE	FALSE		3.75	10.05	8.00	47%	37%	80%		1.26			184.00				12,273							12,273					
5/5/2009	FALSE	FALSE		4.26	9.99	7.90	54%	43%	79%		1.26			167.00	132.00	0.79		11,009	8,701					11,009	8,701					
5/6/2009	FALSE	FALSE		4.03	10.00	7.70	52%	40%	77%		1.30						16.17			1,038							1,038			
5/7/2009	FALSE	FALSE		3.84	9.66	7.52	51%	40%	78%		1.28			248.00	231.00	0.93		15,562	14,495					15,562	14,495					
5/8/2009	FALSE	FALSE		3.77	9.45	7.35	51%	40%	78%		1.29			263.00				16,113						16,113						
5/9/2009	FALSE	FALSE		3.32	9.65	6.93	48%	34%	72%		1.39		7.7																	
5/10/2009	FALSE	FALSE		2.88	9.69	6.83	42%	30%	71%		1.42		7.5																	
5/11/2009	FALSE	FALSE		3.48	9.18	7.11	49%	38%	77%		1.29		7.4	355.00				21,056			TSS			21,056						
5/12/2009	FALSE	FALSE		3.64	9.20	7.24	50%	40%	79%		1.27		7.3	272.00	199.00	0.73		16,415	12,009					16,415	12,009					
5/13/2009	FALSE	FALSE		3.56	9.33	7.24	49%	38%	78%		1.29		7.2																	
5/14/2009	FALSE	FALSE		3.69	9.34	7.15	52%	40%	77%		1.31		7.2	318.00	221.00	0.69		18,957	13,175					18,957	13,175					
5/15/2009	FALSE	FALSE		3.43	9.12	7.08	48%	38%	78%		1.29		7.1	194.00			20.84	11,462		1,231				11,462		1,231				
5/16/2009	FALSE	FALSE		2.83	9.62	6.75	42%	29%	70%	MinAvg	1.43		7.1																	
5/17/2009	FALSE	FALSE		2.82	9.56	6.80	41%	29%	71%	MinAvg	1.41		7.1																	
5/18/2009	FALSE	FALSE		3.14	8.96	7.12	44%	35%	79%		1.26		7.2	220.00				13,060						13,060						
5/19/2009	FALSE	FALSE		3.70	9.80	7.18	52%	38%	73%		1.36		7.2	251.00	184.00	0.73		15,030	11,018					14,745	10,909					
5/20/2009	FALSE	FALSE		3.36	9.32	7.25	46%	36%	78%		1.29		7.2																	
5/21/2009	FALSE	FALSE		3.42	9.16	7.23	47%	37%	79%		1.27		7.2	231.00			21.14	13,929		1,275				13,929		1,275				
5/22/2009	FALSE	FALSE		3.48	9.33	7.23	48%	37%	77%		1.29		7.2	261.00	213.00	0.82		15,738	12,844					15,738	12,844					
5/23/2009	FALSE	FALSE		3.30	9.60	6.94	48%	34%	72%		1.38		7.2																	
5/24/2009	FALSE	TRUE		3.17	9.33	6.48	49%	34%	69%		1.44		7.1																	
5/25/2009	FALSE	TRUE		2.64	9.63	6.63	40%	27%	69%	MinAvg	1.45		7.1																	
5/26/2009	FALSE	TRUE		3.19	8.60	6.85	47%	37%	80%		1.26		7.0	207.00	206.00	1.00		11,819	11,762					11,819	11,762					
5/27/2009	FALSE	TRUE		3.37	8.61	6.82	49%	39%	79%		1.26		7.0																	
5/28/2009	FALSE	TRUE		3.51	8.61	6.82	51%	41%	79%		1.26		6.9	209.00			19.88	11,895		1,131				11,895		1,131				
5/29/2009	TRUE	TRUE		3.41	8.50	6.68	51%	40%	79%		1.27		6.8	312.00				17,382						17,382						
5/30/2009	TRUE	TRUE		2.99	8.89	6.39	47%	34%	72%		1.39		6.7									14,401	12,138	1,169			14,382	12,125	1,169	
5/31/2009	TRUE	TRUE		2.70	8.81	6.40	42%	31%	73%		1.38	7.2	6.6									14,401	12,138	1,169			14,382	12,125	1,169	
6/1/2009	TRUE	TRUE		3.06	8.61	6.66	46%	36%	77%		1.29	7.2	6.7	272.00				15,108				14,383	12,001	1,169	15,108		14,364	11,985	1,169	
6/2/2009	TRUE	TRUE		3.36	8.54	6.69	50%	39%	78%		1.28	7.1	6.7	250.00				13,957				14,357	12,001	1,169	13,957		14,339	11,985	1,169	
6/3/2009	TRUE	TRUE		3.35	8.27	6.80	49%	41%	82%		1.22	7.1	6.7									14,357	12,001	1,169			14,339	11,985	1,169	
6/4/2009	TRUE	TRUE		3.67	8.88	6.90	53%	41%	78%		1.29	7.0	6.7	322.00				18,530				14,748	12,001	1,169	18,530		14,730	11,985	1,169	
6/5/2009	TRUE	TRUE		3.60	8.70	6.82	53%	41%	78%		1.28	7.0	6.7				20.40			1,160		14,997	12,550	1,167		1,160	14,978	12,532	1,167	
6/6/2009	TRUE	TRUE		3.60	8.80	6.41	56%	41%	73%		1.37	6.9	6.6									14,997	12,550	1,199			14,978	12,532	1,199	
6/7/2009	TRUE	TRUE		2.87	8.85	6.21	46%	32%	70%		1.43	6.9	6.6									14,957	12,161	1,199			14,936	12,140	1,199	
6/8/2009	TRUE	TRUE		3.07	8.71	6.52	47%	35%	75%		1.34	6.9	6.6	248.00				13,481				14,769	12,161	1,199	13,481		14,748	12,140	1,199	
6/9/2009	TRUE	TRUE		3.39	8.29	6.55	52%	41%	79%		1.27	6.8	6.6	227.00				12,397				14,611	12,161	1,199	12,397		14,592	12,140	1,199	
6/10/2009	TRUE	TRUE		3.36	8.38	6.62	51%	40%	79%		1.27	6.8	6.6									14,611	12,161	1,199			14,592	12,140	1,199	
6/11/2009	TRUE	TRUE		3.40	8.29	6.55	52%	41%	79%		1.26	6.8	6.6	250.00	195.00	0.78		13,665	10,659			14,551	11,911	1,199	13,665	10,659	14,534	11,893	1,199	
6/12/2009	TRUE	TRUE		3.29	8.50	6.35	52%	39%	75%		1.34	6.8	6.5	274.00			19.98	14,506		1,058		14,432	11,891	1,171	14,506		14,414	11,869	1,171	
6/13/2009	TRUE	TRUE		2.87	8.43	6.11	47%	34%	73%		1.38	6.7	6.4									14,432	11,891	1,171			14,414	11,869	1,171	
6/14/2009	TRUE	TRUE		2.50	8.50	6.04	41%	29%	71%	MinAvg	1.41	6.7	6.4									14,131	11,571	1,171			14,112	11,543	1,171	
6/15/2009	TRUE	TRUE		2.92	8.42	6.45	45%	35%	77%		1.31	6.7	6.4	237.00				12,741				14,216	11,571	1,156	12,741		14,197	11,543	1,156	
6/16/2009	TRUE	TRUE		3.00	8.40	6.51	46%	36%	78%		1.29	6.7	6.4		204.00					11,076		14,216	11,472	1,156		10,671	14,197	11,369	1,156	
6/17/2009	TRUE	TRUE		3.00	8.40	6.51	46%	36%	78%		1.29	6.7	6.4	260.00				14,116				14,210	11,472	1,156	14,116		14,192	11,369	1,156	
6/18/2009	TRUE	TRUE		3.30	8.20	6.40	52%	40%	78%		1.28	6.7	6.4	256.00	186.00	0.73	19.48	13,664	9,928	1,040		14,247	11,214	1,133	13,664	9,928	1,040	14,230	11,129	1,133
6/19/2009	TRUE	TRUE		3.30	8.31	6.40	52%	40%	77%		1.30	6.6	6.4	235.00				12,543				14,092	11,254	1,133	12,543		14,092	11,173	1,133	
6/20/2009	TRUE	TRUE		2.77	8.46	6.10	45%	33%	72%		1.39	6.6	6.4									14,092	11,254	1,133			14,092	11,173	1,133	
6/21/2009	TRUE	TRUE		2.46	8.20	5.95	41%	30%	73%	MinAvg	1.38	6.6	6.4									14,103	11,254	1,097			14,103	11,173	1,097	
6/22/2009	TRUE	TRUE		3.06	8.43	6.43	48%	36%	76%		1.31	6.5	6.4	231.00				12,380				13,879	10,856	1,097	12,380		13,879	10,755	1,097	
6/23/2009	TRUE	TRUE		3.49	8.07	6.40	55%	43%	79%		1.26	6.5	6.4	167.00	161.00	0.96		8,917	8,596			13,569	10,404	1,097	8,917	8,596	13,569	10,323	1,097	
6/24/2009	TRUE	TRUE		3.49	8.03	6.34	55%	43%	79%		1.27	6.5	6.4									13,569	10,404	1,097			13,569	10,323	1,097	
6/25/2009	TRUE	TRUE		3.51	7.97	6.41	55%	44%	80%		1.24	6.5	6.4				21.37			1,143		13,569	10,404	1,106		1,143	13,569	10,323	1,106	
6/26/2009	TRUE	TRUE		3.20	8.30	6.29	51%	39%	76																					

Date	Butte Break?	CSU Break?	Precip?	Min Influent Flow, mgd	Max Influent Flow, mgd	Avg Influent Flow, mgd	Min % of Avg	Min % of Max	Avg % of Max	Flow Outlier Type	Diurnal Peak Factor (DPF)	30-d Avg of Avg Flow, mgd	7-d Avg of Avg Flow, mgd	Influent TSS Conc., mg/L	Influent BOD Conc., mg/L	BOD/TSS Ratio	Influent NH3-N Conc., mg/L	Avg Inf TSS Load, ppd	Avg Inf BOD Load, ppd	Avg Inf NH3 Load, ppd	Load Outlier Type	30-d Avg of TSS Load, ppd	30-d Avg of BOD Load, ppd	30-d Avg of NH3-N Load, ppd	non-SN TSS Load, ppd	non-SN BOD Load, ppd	non-SN NH3 Load, ppd	30-d Avg of non-SN TSS Load, ppd	30-d Avg of non-SN BOD Load, ppd	30-d Avg of non-SN NH3-N Load, ppd
9/4/2009	FALSE	FALSE		3.41	9.01	7.10	48%	38%	79%		1.27	6.8	7.0	203.00	178.00	0.88		12,024	10,543			12,238	8,868	1,357	12,024	10,543		12,238	8,868	1,357
9/5/2009	FALSE	FALSE		3.08	9.77	6.86	45%	32%	70%		1.42	6.8	7.0									12,238	8,868	1,357				12,238	8,868	1,357
9/6/2009	FALSE	FALSE		2.72	9.61	6.58	41%	28%	68%	MinAvg	1.46	6.8	7.0									12,088	8,686	1,357				12,088	8,686	1,357
9/7/2009	FALSE	FALSE		2.60	9.70	6.90	38%	27%	71%	MinAvg	1.41	6.8	7.0									12,088	8,686	1,357				12,088	8,686	1,357
9/8/2009	FALSE	FALSE		3.20	9.10	7.12	45%	35%	78%		1.28	6.9	7.0	207.00	161.00	0.78		12,292	9,560			12,100	8,811	1,357	12,292	9,560		12,100	8,811	1,357
9/9/2009	FALSE	FALSE		3.50	8.99	7.14	49%	39%	79%		1.26	6.9	7.1									12,100	8,811	1,357				12,100	8,811	1,357
9/10/2009	FALSE	FALSE		3.50	9.10	7.10	49%	38%	78%		1.28	6.9	7.1	228.00			21.52	13,501		1,274		12,344	8,811	1,341	13,501		1,274	12,344	8,811	1,341
9/11/2009	FALSE	FALSE		3.50	9.10	7.00	50%	38%	77%		1.30	6.9	7.1	216.00				12,610				12,395	9,090	1,341	12,610			12,395	9,090	1,341
9/12/2009	FALSE	FALSE		3.30	9.45	6.77	49%	35%	72%		1.40	6.9	7.0									12,395	9,090	1,341				12,395	9,090	1,341
9/13/2009	FALSE	FALSE		3.20	9.90	7.05	45%	32%	71%		1.40	6.9	7.0									12,354	9,092	1,387				12,354	9,092	1,387
9/14/2009	FALSE	FALSE		3.49	9.31	7.54	46%	37%	81%		1.23	7.0	7.1									12,325	9,092	1,387				12,325	9,092	1,387
9/15/2009	FALSE	FALSE		3.72	9.34	7.40	50%	40%	79%		1.26	7.0	7.1	237.00	201.00	0.85	19.28	14,619	12,398	1,189		12,469	9,643	1,348	14,619	12,398	1,189	12,469	9,643	1,348
9/16/2009	FALSE	FALSE		3.90	9.50	7.30	53%	41%	77%		1.30	7.0	7.2									12,469	9,643	1,348				12,469	9,643	1,348
9/17/2009	FALSE	FALSE		3.00	9.00	7.30	41%	33%	81%	MinAvg	1.23	7.0	7.2									12,652	9,643	1,348				12,652	9,643	1,348
9/18/2009	FALSE	FALSE		3.00	9.00	7.30	41%	33%	81%	MinAvg	1.23	7.1	7.2	242.00				14,733				12,805	10,032	1,348	14,733			12,805	10,032	1,348
9/19/2009	FALSE	FALSE		3.00	9.00	7.30	41%	33%	81%	MinAvg	1.23	7.1	7.2									12,805	10,032	1,348				12,805	10,032	1,348
9/20/2009	FALSE	FALSE		3.00	9.00	6.78	44%	33%	75%		1.33	7.1	7.2									12,905	10,032	1,408				12,905	10,032	1,408
9/21/2009	FALSE	FALSE		3.04	9.23	7.23	42%	33%	78%	MinAvg	1.28	7.1	7.3	215.00								12,992	10,032	1,408	12,971			12,992	10,032	1,408
9/22/2009	FALSE	FALSE		3.35	9.37	7.03	48%	36%	75%		1.33	7.1	7.1	220.00	181.00	0.82		12,891	10,606			12,986	10,128	1,408	12,891	10,606		12,986	10,128	1,408
9/23/2009	FALSE	FALSE		3.42	9.42	7.01	49%	36%	74%		1.34	7.1	7.0									12,986	10,128	1,408				12,986	10,128	1,408
9/24/2009	FALSE	FALSE		3.41	9.22	7.09	48%	37%	77%		1.30	7.1	7.0				21.73			1,285		12,998	10,128	1,383			1,285	12,998	10,128	1,383
9/25/2009	FALSE	FALSE		3.46	9.35	6.83	51%	37%	73%		1.37	7.1	6.9		188.00			10,712				13,041	10,462	1,383	10,712			13,041	10,462	1,383
9/26/2009	FALSE	FALSE		2.94	9.33	6.67	44%	32%	72%		1.40	7.0	6.9									13,041	10,462	1,383				13,041	10,462	1,383
9/27/2009	FALSE	FALSE		2.51	9.31	6.72	37%	27%	72%	MinAvg	1.39	7.0	6.9									13,079	10,462	1,427				13,079	10,462	1,427
9/28/2009	FALSE	FALSE		3.25	9.23	7.16	45%	35%	78%		1.29	7.0	7.0	195.00				11,641				12,954	10,462	1,427	11,641			12,954	10,462	1,427
9/29/2009	FALSE	FALSE		3.31	9.19	7.15	46%	36%	78%		1.29	7.0	7.0	165.00	126.00	0.76		9,834	7,509			12,714	10,040	1,427	9,834	7,509		12,714	10,040	1,427
9/30/2009	FALSE	FALSE		3.32	9.16	7.26	46%	36%	79%		1.26	7.1	7.0									12,714	10,040	1,427				12,714	10,040	1,427
10/1/2009	FALSE	FALSE		3.21	8.83	7.09	45%	36%	80%		1.25	7.1	7.0	288.00			24.32	17,025		1,438		12,961	10,040	1,429	17,025		1,438	12,961	10,040	1,429
10/2/2009	FALSE	FALSE		3.40	8.79	7.19	47%	39%	82%		1.22	7.1	7.0	208.00	170.00	0.82		12,466	10,188			13,068	10,217	1,429	12,466	10,188		13,068	10,217	1,429
10/3/2009	FALSE	FALSE		3.09	9.41	6.57	47%	33%	70%		1.43	7.1	7.0									13,068	10,217	1,429				13,068	10,217	1,429
10/4/2009	FALSE	FALSE		1.44	7.78	6.82	21%	19%	88%	gMinMaxA	1.14	7.1	7.1									13,051	10,217	1,296				13,051	10,217	1,296
10/5/2009	FALSE	FALSE		2.82	9.37	6.98	40%	30%	75%	MinAvg	1.34	7.1	7.1	217.00				12,636				13,102	10,162	1,296	12,636			13,102	10,162	1,296
10/6/2009	FALSE	FALSE		3.09	9.03	7.17	43%	34%	79%		1.26	7.1	7.1	212.00	131.00	0.62		12,681	7,836			13,069	9,830	1,296	12,681	7,836		13,069	9,830	1,296
10/7/2009	FALSE	FALSE		3.14	9.04	7.12	44%	35%	79%		1.27	7.1	7.1				19.71			1,170		13,069	9,830	1,271			1,170	13,069	9,830	1,271
10/8/2009	FALSE	FALSE		3.29	9.37	7.19	46%	35%	77%		1.30	7.1	7.1	215.00				12,896				13,057	9,830	1,271	12,896			13,057	9,830	1,271
10/9/2009	FALSE	FALSE		3.25	9.19	7.02	46%	35%	76%		1.31	7.1	7.0	199.00				11,647				13,011	9,875	1,271	11,647			13,011	9,875	1,271
10/10/2009	FALSE	FALSE		3.26	9.76	6.80	48%	33%	70%		1.43	7.1	7.0									13,011	9,875	1,271				13,011	9,875	1,271
10/11/2009	FALSE	FALSE		2.68	9.30	6.84	39%	29%	74%	MinAvg	1.36	7.1	7.1									12,973	9,875	1,270				12,973	9,875	1,270
10/12/2009	FALSE	FALSE		2.96	9.57	7.38	40%	31%	77%	MinAvg	1.30	7.1	7.1	343.00				21,123			TSS	13,003	9,875	1,270	21,123			13,003	9,875	1,270
10/13/2009	FALSE	FALSE		3.39	9.96	8.26	41%	34%	83%	MinAvg	1.21	7.1	7.1	228.00	175.00	0.77		15,714	12,061			13,212	10,187	1,270	15,714	12,061		13,212	10,187	1,270
10/14/2009	FALSE	FALSE		4.23	9.80	8.33	51%	43%	85%		1.18	7.1	7.3									13,212	10,187	1,270				13,212	10,187	1,270
10/15/2009	FALSE	FALSE		4.05	9.60	7.56	54%	42%	79%		1.27	7.1	7.4	213.00			18.64	13,423		1,175		13,227	10,187	1,251	13,423		1,175	13,227	10,187	1,251
10/16/2009	FALSE	FALSE		3.72	8.92	7.37	50%	42%	83%		1.21	7.1	7.4	183.00	183.00	1.00		11,251	11,251			12,986	10,023	1,267	11,251	11,251		12,986	10,023	1,267
10/17/2009	FALSE	FALSE		3.50	9.37	7.08	49%	37%	76%		1.32	7.1	7.4									12,986	10,023	1,267				12,986	10,023	1,267
10/18/2009	FALSE	FALSE		3.30	10.02	7.43	44%	33%	74%		1.35	7.1	7.6									12,986	10,023	1,267				12,986	10,023	1,267
10/19/2009	FALSE	FALSE		3.29	9.58	6.80	48%	34%	71%		1.41	7.1	7.4	190.00				10,775				12,704	10,023	1,267	10,775			12,704	10,023	1,267
10/20/2009	FALSE	FALSE		3.52	9.40	6.22	57%	37%	66%		1.51	7.1	7.3	221.00	188.00	0.85		11,464	9,752			12,621	9,990	1,267	11,464	9,752		12,621	9,990	1,267
10/21/2009	FALSE	FALSE		3.31	9.57	7.01	47%	35%	73%		1.37	7.1	7.2				19.49			1,139		12,621	9,990	1,241			1,139	12,621	9,990	1,241
10/22/2009	FALSE	FALSE		3.37	9.54	7.04	48%	35%	74%		1.36	7.1	7.1									12,596	9,990	1,241				12,596	9,990	1,241
10/23/2009	FALSE	FALSE		3.42	9.26	6.96	49%	37%	75%		1.33	7.1	7.0	279.00	241.00	0.86		16,200	13,993			12,832	10,413	1,241	16,200	13,993		12,832	10,413	1,241
10/24/2009																														

Date	Butte Break?	CSU Break?	Precip?	Min Influent Flow, mgd	Max Influent Flow, mgd	Avg Influent Flow, mgd	Min % of Avg	Min % of Max	Avg % of Max	Flow Outlier Type	Diurnal Peak Factor (DPF)	30-d Avg of Avg Flow, mgd	7-d Avg of Avg Flow, mgd	Influent TSS Conc., mg/L	Influent BOD Conc., mg/L	BOD/TSS Ratio	Influent NH3-N Conc., mg/L	Avg Inf TSS Load, ppd	Avg Inf BOD Load, ppd	Avg Inf NH3 Load, ppd	Load Outlier Type	30-d Avg of TSS Load, ppd	30-d Avg of BOD Load, ppd	30-d Avg of NH3-N Load, ppd	non-SN TSS Load, ppd	non-SN BOD Load, ppd	non-SN NH3 Load, ppd	30-d Avg of non-SN TSS Load, ppd	30-d Avg of non-SN BOD Load, ppd	30-d Avg of non-SN NH3-N Load, ppd
11/6/2009	FALSE	FALSE		3.21	8.90	6.97	46%	36%	78%		1.28	7.1	7.1	241.00	205.00	0.85		14,009	11,917			13,591	11,747	1,217	14,009	11,917		13,591	11,747	1,217
11/7/2009	FALSE	FALSE		2.79	9.43	6.91	40%	30%	73%	MinAvg	1.36	7.1	7.1									13,591	11,747	1,229				13,591	11,747	1,229
11/8/2009	FALSE	FALSE		2.71	9.27	6.84	40%	29%	74%	MinAvg	1.35	7.1	7.1									13,644	11,747	1,229				13,644	11,747	1,229
11/9/2009	FALSE	FALSE		2.81	8.76	7.19	39%	32%	82%	MinAvg	1.22	7.1	7.1	205.00				12,289				13,694	11,747	1,229	12,289			13,694	11,747	1,229
11/10/2009	FALSE	FALSE		2.81	9.38	6.89	41%	30%	73%	MinAvg	1.36	7.1	7.1	279.00	192.00	0.69	22.10	16,039	11,038	1,270		13,861	11,658	1,237	16,039	11,038	1,270	13,861	11,658	1,237
11/11/2009	FALSE	FALSE		3.33	9.65	7.28	46%	35%	75%		1.33	7.1	7.1									13,861	11,658	1,237				13,861	11,658	1,237
11/12/2009	FALSE	FALSE		3.37	10.39	6.35	53%	32%	61%		1.64	7.1	6.9									13,861	11,658	1,237				13,861	11,658	1,237
11/13/2009	FALSE	FALSE		3.38	8.84	6.64	51%	38%	75%		1.33	7.0	6.8									13,719	11,601	1,237				13,719	11,601	1,237
11/14/2009	FALSE	FALSE		2.78	9.58	6.83	41%	29%	71%	MinAvg	1.40	7.0	6.8									13,719	11,601	1,237				13,719	11,601	1,237
11/15/2009	FALSE	FALSE		2.64	9.30	6.85	39%	28%	74%	MinAvg	1.36	7.0	6.8									13,743	11,601	1,253				13,743	11,601	1,253
11/16/2009	FALSE	FALSE		2.96	8.93	7.10	42%	33%	79%	MinAvg	1.26	6.9	6.8	277.00	229.00	0.83		16,398	13,556			14,172	11,930	1,253	16,398	13,556		14,172	11,930	1,253
11/17/2009	FALSE	FALSE		3.04	9.25	7.25	42%	33%	78%	MinAvg	1.28	6.9	6.8									14,172	11,930	1,253				14,172	11,930	1,253
11/18/2009	FALSE	FALSE		3.32	9.18	7.43	45%	36%	81%		1.24	6.9	6.9									14,172	11,930	1,253				14,172	11,930	1,253
11/19/2009	FALSE	FALSE		3.19	8.90	7.20	44%	36%	81%		1.24	6.9	6.9	294.00			21.13	17,659		1,269		14,746	11,930	1,256	17,659		1,269	14,746	11,930	1,256
11/20/2009	FALSE	TRUE		3.33	9.43	7.25	46%	35%	77%		1.30	7.0	7.1	220.00				13,304				14,899	12,293	1,256	13,304			14,899	12,293	1,256
11/21/2009	FALSE	TRUE		3.38	9.48	6.94	49%	36%	73%		1.37	7.0	7.2									14,899	12,293	1,285				14,899	12,293	1,285
11/22/2009	FALSE	TRUE		3.19	8.94	6.74	47%	36%	75%		1.33	7.0	7.1									14,899	12,293	1,285				14,899	12,293	1,285
11/23/2009	FALSE	TRUE		2.94	8.61	6.88	43%	34%	80%		1.25	7.0	7.1	216.00								14,582	11,953	1,285	12,394			14,582	11,953	1,285
11/24/2009	FALSE	TRUE		3.14	8.26	6.56	48%	38%	79%		1.26	7.0	7.0	235.00	203.00	0.86	19.19	12,855	11,105	1,050		14,449	11,812	1,238	12,855	11,105	1,050	14,449	11,812	1,238
11/25/2009	TRUE	TRUE		3.19	8.61	6.64	48%	37%	77%		1.30	6.9	7.0									14,449	11,812	1,238				14,449	11,812	1,238
11/26/2009	TRUE	TRUE		2.89	8.77	5.74	50%	33%	65%		1.53	6.9	6.7									14,347	11,812	1,238				14,347	11,812	1,238
11/27/2009	TRUE	TRUE		3.21	8.33	6.18	52%	39%	74%		1.35	6.8	6.6									14,491	11,812	1,238				14,491	11,812	1,238
11/28/2009	TRUE	TRUE		2.83	9.03	5.91	48%	31%	65%		1.53	6.8	6.4									14,491	11,812	1,238				14,491	11,812	1,238
11/29/2009	TRUE	TRUE		2.80	9.11	7.07	40%	31%	78%	MinAvg	1.29	6.8	6.4									14,491	11,812	1,256				14,491	11,812	1,256
11/30/2009	TRUE	TRUE		2.80	9.01	7.07	40%	31%	78%	MinAvg	1.27	6.8	6.3									14,176	11,610	1,256				14,176	11,610	1,256
12/1/2009	FALSE	FALSE		3.16	9.06	7.04	45%	35%	78%		1.29	6.8	6.3	228.00	205.00	0.90		13,387	12,036			14,104	11,681	1,256	13,387	12,036		14,104	11,681	1,256
12/2/2009	FALSE	FALSE		3.10	9.60	7.50	41%	32%	78%	MinAvg	1.28	6.8	6.3				21.93			1,372		14,104	11,681	1,279			1,372	14,104	11,681	1,279
12/3/2009	FALSE	FALSE		3.10	9.60	6.89	45%	32%	72%		1.39	6.8	6.4	228.00				13,100				14,080	11,681	1,279	13,100			14,080	11,681	1,279
12/4/2009	FALSE	FALSE		3.11	8.92	6.85	45%	35%	77%		1.30	6.8	6.6	242.00	219.00	0.90		13,825	12,511			14,114	12,027	1,279	13,825	12,511		14,114	12,027	1,279
12/5/2009	FALSE	FALSE		3.17	9.67	6.79	47%	33%	70%		1.42	6.8	6.7									14,114	12,027	1,279				14,114	12,027	1,279
12/6/2009	FALSE	FALSE		3.10	10.13	6.80	46%	31%	67%		1.49	6.8	6.9									14,114	12,027	1,240				14,114	12,027	1,240
12/7/2009	FALSE	FALSE		2.98	8.92	7.19	41%	33%	81%	MinAvg	1.24	6.7	6.9	220.00				13,196				14,040	12,049	1,240	13,196			14,040	12,049	1,240
12/8/2009	FALSE	FALSE		3.18	8.51	6.99	46%	37%	82%		1.22	6.8	6.9	205.00	195.00	0.95		11,944	11,361			13,866	11,935	1,240	11,944	11,361		13,866	11,935	1,240
12/9/2009	FALSE	FALSE		3.33	8.72	7.15	47%	38%	82%		1.22	6.8	6.9									13,866	11,935	1,240				13,866	11,935	1,240
12/10/2009	FALSE	FALSE		3.37	8.62	7.10	47%	39%	82%		1.21	6.8	6.9	254.00			22.23	15,036		1,316		14,095	11,935	1,255	15,036		1,316	14,095	11,935	1,255
12/11/2009	FALSE	FALSE		3.40	8.70	7.74	44%	39%	89%	AvgMax	1.12	6.8	6.9	241.00				15,553				14,054	12,114	1,252	15,553			14,054	12,114	1,252
12/12/2009	FALSE	FALSE				6.49				gMinMaxA	0.00	6.8	7.0									14,054	12,114	1,252				14,054	12,114	1,252
12/13/2009	FALSE	FALSE				7.57				gMinMaxA	0.00	6.8	7.0									14,054	12,114	1,252				14,054	12,114	1,252
12/14/2009	FALSE	FALSE		4.26	9.88	8.32	51%	43%	84%		1.19	6.9	7.4	160.00				11,102				13,827	12,114	1,252	11,102			13,827	12,114	1,252
12/15/2009	FALSE	FALSE		4.28	9.53	7.70	56%	45%	81%		1.24	6.9	7.5	261.00	181.00	0.69		16,763	11,625			14,037	12,032	1,252	16,763	11,625		14,037	12,032	1,252
12/16/2009	FALSE	FALSE		4.51	10.11	8.35	54%	45%	83%		1.21	7.0	7.7									14,037	12,032	1,252				14,037	12,032	1,252
12/17/2009	FALSE	FALSE		4.24	9.89	8.08	53%	43%	82%		1.22	7.0	7.9	227.00			17.59	15,289		1,185		13,958	11,728	1,238	15,289		1,185	13,958	11,728	1,238
12/18/2009	TRUE	TRUE		4.13	9.30	7.46	55%	44%	80%		1.25	7.0	8.0	193.00	190.00	0.98		12,000	11,813			13,827	11,742	1,238	12,000	11,813		13,827	11,742	1,238
12/19/2009	TRUE	TRUE		3.58	9.48	6.92	52%	38%	73%		1.37	7.0	7.8									13,827	11,742	1,238				13,827	11,742	1,238
12/20/2009	TRUE	TRUE		3.41	9.06	6.74	51%	38%	74%		1.34	7.0	7.7	260.00				14,615				13,624	11,742	1,231	14,615			13,624	11,742	1,231
12/21/2009	TRUE	TRUE		3.54	9.21	7.28	49%	38%	79%		1.26	7.0	7.6									13,647	11,742	1,231				13,647	11,742	1,231
12/22/2009	TRUE	TRUE		3.65	9.02	7.05	52%	40%	78%		1.28	7.0	7.4	238.00			18.62	13,986		1,094		13,670	11,742	1,203	13,986		1,094	13,670	11,742	1,203
12/23/2009	TRUE	TRUE		3.47	8.65	7.13	49%	40%	82%		1.21	7.0	7.4	244.00	193.00	0.79		14,509	11,477			13,722	11,704	1,203	14,509	11,477		13,722	11,704	1,203
12/24/2009	TRUE	TRUE		3.30	9.96	5.87	56%	33%	59%		1.70	7.0	7.1									13,811	11,704	1,203				13,811	11,704	1,203
12/25/2009	TRUE	TRUE		2.53	8.50	5.40	47%	30%	64%		1.57	6.9	6.7									13,879	11,804	1,242				13,879	11,804	1,242
12/26/2009	TRUE																													

Date	Butte Break?	CSU Break?	Precip?	Min Influent Flow, mgd	Max Influent Flow, mgd	Avg Influent Flow, mgd	Min % of Avg	Min % of Max	Avg % of Max	Flow Outlier Type	Diurnal Peak Factor (DPF)	30-d Avg of Avg Flow, mgd	7-d Avg of Avg Flow, mgd	Influent TSS Conc., mg/L	Influent BOD Conc., mg/L	BOD/TSS Ratio	Influent NH3-N Conc., mg/L	Avg Inf TSS Load, ppd	Avg Inf BOD Load, ppd	Avg Inf NH3 Load, ppd	Load Outlier Type	30-d Avg of TSS Load, ppd	30-d Avg of BOD Load, ppd	30-d Avg of NH3-N Load, ppd	non-SN TSS Load, ppd	non-SN BOD Load, ppd	non-SN NH3 Load, ppd	30-d Avg of non-SN TSS Load, ppd	30-d Avg of non-SN BOD Load, ppd	30-d Avg of non-SN NH3-N Load, ppd
1/8/2010	TRUE	TRUE	TRUE	3.61	7.79	6.35	57%	46%	81%		1.23	6.9	6.6	243.00	207.00	0.85		12,861	10,956			13,891	11,353	1,152	12,861	10,956		13,891	11,353	1,152
1/9/2010	TRUE	TRUE	TRUE	3.08	7.95	6.41	48%	39%	81%		1.24	6.9	6.6									13,891	11,353	1,152				13,891	11,353	1,152
1/10/2010	TRUE	TRUE	FALSE	3.10	8.70	6.57	47%	36%	76%		1.32	6.9	6.6									13,809	11,353	1,110				13,809	11,353	1,110
1/11/2010	TRUE	TRUE	TRUE	4.20	8.80	7.01	60%	48%	80%		1.26	6.9	6.6	189.00			20.44	11,050		1,195		13,487	11,353	1,127	11,050		1,195	13,487	11,353	1,127
1/12/2010	TRUE	TRUE	TRUE	4.19	8.66	7.82	54%	48%	90%	AvgMax	1.11	6.9	6.6	198.00	177.00	0.89		12,908	11,539			13,449	11,380	1,127	12,908	11,539		13,449	11,380	1,127
1/13/2010	TRUE	TRUE	TRUE	5.30	9.32	7.74	68%	57%	83%	MinMax	1.20	6.9	6.6									13,449	11,380	1,127				13,449	11,380	1,127
1/14/2010	TRUE	TRUE	FALSE	4.42	9.08	7.55	59%	49%	83%		1.20	6.8	6.8	167.00	173.00	1.04		10,510	10,888			13,409	11,318	1,127	10,510	10,888		13,409	11,318	1,127
1/15/2010	TRUE	TRUE	FALSE	3.98	8.66	7.33	54%	46%	85%		1.18	6.8	6.9	228.00				13,936				13,221	11,274	1,127	13,936			13,221	11,274	1,127
1/16/2010	TRUE	TRUE	TRUE	3.82	9.34	6.93	55%	41%	74%		1.35	6.8	7.0									13,221	11,274	1,127				13,221	11,274	1,127
1/17/2010	TRUE	TRUE	TRUE	4.05	11.05	8.35	49%	37%	76%		1.32	6.8	7.3									13,073	11,274	1,113				13,073	11,274	1,113
1/18/2010	TRUE	TRUE	TRUE	6.38	13.96	11.14	57%	46%	80%		1.25	6.9	8.0									13,155	11,184	1,113				13,155	11,184	1,113
1/19/2010	TRUE	TRUE	TRUE	7.18	13.65	11.93	60%	53%	87%	AvgMax	1.14	6.9	8.3	258.00				25,670			TSS	13,155	11,184	1,113	24,870			13,155	11,184	1,113
1/20/2010	TRUE	TRUE	TRUE	8.53	14.56	12.44	69%	59%	85%	MinMax	1.17	6.9	8.3	123.00				12,757				13,012	11,184	1,113	12,757			13,012	11,184	1,113
1/21/2010	TRUE	TRUE	TRUE	8.46	13.27	11.88	71%	64%	90%	gMinMaxA	1.12	6.9	8.3	114.00			10.71	11,297		1,061		12,890	11,184	1,103	11,297		1,061	12,890	11,184	1,103
1/22/2010	TRUE	TRUE	FALSE	7.70	13.30	10.82	71%	58%	81%	inAvgMinM	1.23	6.9	8.4	155.00	138.00	0.89		13,987	12,453			12,890	11,366	1,105	13,987	12,453		12,890	11,366	1,105
1/23/2010	TRUE	TRUE	TRUE	4.50	12.20	9.05	50%	37%	74%		1.35	7.0	8.9									12,765	11,347	1,105				12,765	11,347	1,105
1/24/2010	TRUE	TRUE	TRUE	5.47	12.00	9.22	59%	46%	77%		1.30	7.1	9.4									12,765	11,347	1,105				12,765	11,347	1,105
1/25/2010	TRUE	TRUE	TRUE	5.80	14.61	12.12	48%	40%	83%		1.21	7.4	10.4	190.00				19,197				13,225	11,347	1,105	19,197			13,225	11,347	1,105
1/26/2010	FALSE	FALSE	TRUE	8.73	13.69	11.45	76%	64%	84%	inAvgMinM	1.20	7.4	10.1	171.00	135.00	0.79		16,331	12,893			13,432	11,568	1,105	16,331	12,893		13,432	11,568	1,105
1/27/2010	FALSE	FALSE	FALSE	6.33	11.63	9.06	70%	54%	78%	MinAvg	1.28	7.5	10.1									13,432	11,568	1,105				13,432	11,568	1,105
1/28/2010	FALSE	FALSE	FALSE	5.98	11.70	9.88	61%	51%	84%		1.18	7.6	10.1				11.06			911		13,432	11,568	1,066			911	13,432	11,568	1,066
1/29/2010	FALSE	FALSE	FALSE	5.81	10.82	9.48	61%	54%	88%	AvgMax	1.14	7.6	10.1	223.00	176.00	0.79		17,622	13,908			13,694	12,005	1,066	17,622	13,908		13,694	12,005	1,066
1/30/2010	FALSE	FALSE	TRUE	5.81	11.70	9.38	62%	50%	80%		1.25	7.7	9.9									13,790	12,005	1,066				13,790	12,005	1,066
1/31/2010	FALSE	FALSE	FALSE	5.14	11.38	9.19	56%	45%	81%		1.24	7.8	10.0									13,830	12,005	1,074				13,830	12,005	1,074
2/1/2010	FALSE	FALSE	TRUE	5.22	10.71	9.06	58%	49%	85%		1.18	8.0	9.9	257.00				19,425				14,203	12,005	1,074	19,425			14,203	12,005	1,074
2/2/2010	FALSE	FALSE	TRUE	5.14	10.67	8.57	60%	48%	80%		1.25	8.1	9.2	165.00	178.00	1.08		11,786	12,715			14,052	12,094	1,074	11,786	12,715		14,052	12,094	1,074
2/3/2010	FALSE	FALSE	TRUE			7.43				gMinMaxA	0.00	8.1	9.2									14,052	12,094	1,074				14,052	12,094	1,074
2/4/2010	FALSE	FALSE	TRUE	4.53	11.07	9.19	49%	41%	83%		1.20	8.3	9.2	197.00			15.04	15,101		1,153		14,181	12,094	1,090	15,101		1,153	14,181	12,094	1,090
2/5/2010	FALSE	FALSE	TRUE	6.89	14.60	10.29	67%	47%	71%		1.42	8.4	9.3	225.00	187.00	0.83		19,317	16,054			14,579	12,676	1,090	19,317	16,054		14,579	12,676	1,090
2/6/2010	FALSE	FALSE	TRUE	7.08	13.53	11.04	64%	52%	82%		1.23	8.6	9.5									14,579	12,676	1,090				14,579	12,676	1,090
2/7/2010	FALSE	FALSE	TRUE	6.78	12.09	10.01	68%	56%	83%	MinMax	1.21	8.7	9.6									14,539	12,676	1,080				14,539	12,676	1,080
2/8/2010	FALSE	FALSE	TRUE	5.86	11.30	10.00	59%	52%	88%	AvgMax	1.13	8.9	9.6	159.00				13,261				14,566	12,921	1,080	13,261			14,566	12,921	1,080
2/9/2010	FALSE	FALSE	TRUE	4.87	13.98	9.30	52%	35%	67%		1.50	9.0	9.7	154.00	132.00	0.86		11,945	10,238			14,402	12,586	1,080	11,945	10,238		14,402	12,586	1,080
2/10/2010	FALSE	FALSE	FALSE	6.31	12.20	9.20	69%	52%	75%		1.33	9.1	9.8				8.56			657		14,402	12,586	995			657	14,402	12,586	995
2/11/2010	FALSE	FALSE	FALSE	4.68	12.04	9.10	51%	39%	76%		1.32	9.3	9.7	275.00	196.00	0.71		20,871	14,875		TSS	14,625	12,840	946	20,871	14,875		14,625	12,840	946
2/12/2010	FALSE	FALSE	TRUE	6.65	9.99	8.29	80%	67%	83%	inAvgMinM	1.20	9.3	9.8	209.00				14,457				14,729	13,003	946	14,457			14,729	13,003	946
2/13/2010	FALSE	FALSE	FALSE	6.09	9.18	9.74	63%	66%	106%	inMaxAvgM	0.94	9.3	9.7									14,729	13,003	946				14,729	13,003	946
2/14/2010	FALSE	FALSE	FALSE	5.39	9.15	7.55	71%	59%	83%	inAvgMinM	1.21	9.4	9.2									15,030	13,305	946				15,030	13,305	946
2/15/2010	FALSE	FALSE	FALSE	4.64	10.07	6.83	68%	46%	68%		1.47	9.3	8.6									15,114	13,305	946				15,114	13,305	946
2/16/2010	FALSE	FALSE	FALSE	5.18	9.86	8.24	63%	53%	84%		1.20	9.4	8.5	193.00				13,270				14,982	13,305	946	13,270			14,982	13,305	946
2/17/2010	FALSE	FALSE	FALSE	4.86	9.48	7.01	69%	51%	74%		1.35	9.3	8.1									14,982	13,305	946				14,982	13,305	946
2/18/2010	FALSE	FALSE	FALSE	4.82	11.28	7.72	62%	43%	68%		1.46	9.1	7.8	308.00			14.33	19,841		923		15,306	13,305	941	19,841		923	15,306	13,305	941
2/19/2010	FALSE	FALSE	FALSE	2.71	8.45	7.70	35%	32%	91%	inAvgAvgM	1.10	9.1	7.5	253.00	213.00	0.84		16,243	13,675			15,365	13,351	941	16,243	13,675		15,365	13,351	941
2/20/2010	FALSE	FALSE	TRUE	3.99	10.61	7.36	54%	38%	69%		1.44	9.0	7.4									15,539	13,351	941				15,539	13,351	941
2/21/2010	FALSE	FALSE	FALSE	3.67	9.77	7.65	48%	38%	78%		1.28	9.0	7.5									15,842	13,351	911				15,842	13,351	911
2/22/2010	FALSE	FALSE	FALSE	3.79	9.29	7.82	48%	41%	84%		1.19	8.9	7.5	194.00				12,649				15,746	13,480	911	12,649			15,746	13,480	911
2/23/2010	FALSE	FALSE	TRUE	3.66	9.13	8.62	42%	40%	94%	AvgMax	1.06	8.9	7.6	199.00	184.00	0.92		14,313	13,234			15,650	13,449	911	14,313	13,234		15,650	13,449	911
2/24/2010	FALSE	FALSE	TRUE	7.03	12.00	9.00	78%	59%	75%	inAvgMinM	1.33	8.9	7.5									15,650	13,449	911				15,650	13,449	911
2/25/2010	FALSE	FALSE	FALSE	6.53	11.81	8.26	79%	55%	70%	inAvgMinM	1.43	8.7	7.6	178.00			12.74	12,268		878		15,188	13,449	904	12,268		878	15,188	13,449	904
2/26/2010	FALSE	FALSE	TRUE	5.																										

Date	Butte Break?	CSU Break?	Precip?	Min Influent Flow, mgd	Max Influent Flow, mgd	Avg Influent Flow, mgd	Min % of Avg	Min % of Max	Avg % of Max	Flow Outlier Type	Diurnal Peak Factor (DPF)	30-d Avg of Avg Flow, mgd	7-d Avg of Avg Flow, mgd	Influent TSS Conc., mg/L	Influent BOD Conc., mg/L	BOD/TSS Ratio	Influent NH3-N Conc., mg/L	Avg Inf TSS Load, ppd	Avg Inf BOD Load, ppd	Avg Inf NH3 Load, ppd	Load Outlier Type	30-d Avg of TSS Load, ppd	30-d Avg of BOD Load, ppd	30-d Avg of NH3-N Load, ppd	non-SN TSS Load, ppd	non-SN BOD Load, ppd	non-SN NH3 Load, ppd	30-d Avg of non-SN TSS Load, ppd	30-d Avg of non-SN BOD Load, ppd	30-d Avg of non-SN NH3-N Load, ppd
3/12/2010	TRUE	TRUE	TRUE	2.85	8.86	7.60	38%	32%	86%	inAvgAvgM	1.17	7.8	7.7	205.00	186.00	0.91		12,994	11,789			13,523	11,877	867	12,994	11,789		13,507	11,867	867
3/13/2010	TRUE	TRUE	FALSE	2.41	8.37	6.98	35%	29%	83%	MinAvg	1.20	7.7	7.6									13,523	11,877	919				13,507	11,867	919
3/14/2010	TRUE	TRUE	FALSE			6.72				igMinMaxA	0.00	7.6	7.3									13,523	11,378	919				13,507	11,366	919
3/15/2010	TRUE	TRUE	FALSE			6.78				igMinMaxA	0.00	7.6	7.3	214.00				12,101				13,376	11,378	919	12,101			13,360	11,366	919
3/16/2010	TRUE	TRUE	FALSE			6.65				igMinMaxA	0.00	7.6	7.3	181.00	154.00	0.85		10,038	8,541			13,179	10,972	919	10,038	8,541		13,164	10,963	919
3/17/2010	TRUE	TRUE	FALSE			7.22				igMinMaxA	0.00	7.6	#DIV/0!									13,179	10,972	919				13,164	10,963	919
3/18/2010	TRUE	TRUE	FALSE			6.83				igMinMaxA	0.00	7.7	#DIV/0!	109.00				6,209				12,792	10,972	919	6,209			12,778	10,963	919
3/19/2010	TRUE	TRUE	FALSE	2.67	7.97	6.07	44%	34%	76%		1.31	7.4	6.1	210.00			15.78	10,635		799		12,646	10,972	895	10,635		799	12,632	10,963	895
3/20/2010	TRUE	TRUE	FALSE	3.19	9.17	6.70	48%	35%	73%		1.37	7.4	6.4									12,646	10,972	895				12,632	10,963	895
3/21/2010	TRUE	TRUE	FALSE	3.15	8.90	6.82	46%	35%	77%		1.31	7.3	6.5									12,222	10,972	888				12,207	10,963	888
3/22/2010	TRUE	TRUE	FALSE	3.31	8.94	7.46	44%	37%	83%		1.20	7.3	6.8	265.00				16,483				12,236	10,522	888	16,483			12,222	10,511	888
3/23/2010	FALSE	FALSE	FALSE	3.37	9.00	6.79	50%	37%	75%		1.32	7.3	6.8	242.00	229.00	0.95		13,710	12,974			12,318	10,872	888	13,710	12,974		12,304	10,862	888
3/24/2010	FALSE	FALSE	TRUE			7.59				igMinMaxA	0.00	7.2	6.8									12,318	10,872	888				12,304	10,862	888
3/25/2010	FALSE	FALSE	TRUE			7.53				igMinMaxA	0.00	7.1	6.8	247.00			20.33	15,512		1,277		12,477	10,872	966	15,512		1,277	12,463	10,862	966
3/26/2010	FALSE	FALSE	FALSE	3.46	8.99	6.52	53%	38%	73%		1.38	7.1	6.7	212.00				11,524				12,322	10,478	966	11,524			12,308	10,467	966
3/27/2010	FALSE	FALSE	FALSE	3.05	9.38	6.95	44%	33%	74%		1.35	7.1	6.9									12,322	10,478	966				12,308	10,467	966
3/28/2010	FALSE	FALSE	FALSE	3.12	10.07	7.12	44%	31%	71%		1.41	7.1	6.9									12,326	10,478	988				12,311	10,467	988
3/29/2010	FALSE	FALSE	FALSE	3.28	9.41	7.16	46%	35%	76%		1.31	7.1	7.0									12,363	10,362	988				12,363	10,362	988
3/30/2010	FALSE	FALSE	FALSE	3.35	9.35	7.23	46%	36%	77%		1.29	7.1	7.0	356.00	239.00	0.67		21,451	14,401		TSS	12,363	11,035	988	21,451	14,401		12,363	11,035	988
3/31/2010	FALSE	FALSE	FALSE	3.32	9.38	7.10	47%	35%	76%		1.32	7.1	7.0									12,363	11,035	988				12,363	11,035	988
4/1/2010	FALSE	FALSE	FALSE	3.65	9.22	6.96	52%	40%	75%		1.33	7.1	7.0	221.00			21.12	12,821		1,225		12,280	11,035	1,035	12,821		1,225	12,280	11,035	1,035
4/2/2010	FALSE	FALSE	TRUE	3.44	10.37	7.17	48%	33%	69%		1.45	7.1	7.0	185.00	203.00	1.10		11,061	12,137			12,194	11,465	1,035	11,061	12,137		12,194	11,465	1,035
4/3/2010	FALSE	FALSE	FALSE	3.32	9.15	6.86	48%	36%	75%		1.33	7.1	7.1									12,194	11,465	1,067				12,194	11,465	1,067
4/4/2010	FALSE	FALSE	FALSE	5.00	11.50	7.23	69%	43%	63%		1.59	7.1	7.1									12,212	11,465	1,067				12,212	11,465	1,067
4/5/2010	FALSE	FALSE	FALSE	3.84	9.68	7.95	48%	40%	82%		1.22	7.1	7.2	237.00				15,712				12,423	11,465	1,067	15,712			12,423	11,465	1,067
4/6/2010	FALSE	FALSE	FALSE	3.68	9.37	7.71	48%	39%	82%		1.22	7.1	7.3	224.00	211.00	0.94		14,398	13,562			12,547	11,765	1,067	14,398	13,562		12,547	11,765	1,067
4/7/2010	FALSE	FALSE	FALSE	3.59	9.32	7.26	49%	39%	78%		1.28	7.1	7.3									12,547	11,765	1,067				12,547	11,765	1,067
4/8/2010	FALSE	FALSE	FALSE	3.65	8.97	7.55	48%	41%	84%		1.19	7.1	7.3	212.00			21.53	13,342		1,355		12,595	11,765	1,124	13,342		1,355	12,595	11,765	1,124
4/9/2010	FALSE	FALSE	FALSE	3.60	9.00	7.42	49%	40%	82%		1.21	7.1	7.4	203.00	203.00	1.00		12,562	12,562			12,718	12,281	1,124	12,562	12,562		12,718	12,281	1,124
4/10/2010	FALSE	FALSE	FALSE	3.70	9.20	7.10	52%	40%	77%		1.30	7.1	7.4									12,718	12,281	1,124				12,718	12,281	1,124
4/11/2010	FALSE	FALSE	TRUE	3.39	10.35	8.47	40%	33%	82%	MinAvg	1.22	7.1	7.5									12,607	12,281	1,164				12,607	12,281	1,164
4/12/2010	FALSE	FALSE	TRUE	5.60	11.83	10.00	56%	47%	85%		1.18	7.2	7.9	239.00				19,933				13,069	12,363	1,164	19,933			13,069	12,363	1,164
4/13/2010	FALSE	FALSE	TRUE	5.96	11.67	9.65	62%	51%	83%		1.21	7.3	8.1	218.00	159.00	0.73		17,543	12,795			13,349	12,425	1,164	17,543	12,795		13,349	12,425	1,164
4/14/2010	FALSE	FALSE	TRUE	5.04	11.50	9.17	55%	44%	80%		1.25	7.4	8.3									13,349	12,425	1,164				13,349	12,425	1,164
4/15/2010	FALSE	FALSE	FALSE	4.80	10.11	8.37	57%	47%	83%		1.21	7.5	8.5	206.00			14.37	14,383		1,003		13,492	12,425	1,132	14,383		1,003	13,492	12,425	1,132
4/16/2010	FALSE	FALSE	FALSE	4.44	9.87	7.92	56%	45%	80%		1.25	7.5	8.5	243.00	176.00	0.72		16,059	11,631			13,868	12,866	1,132	16,059	11,631		13,868	12,866	1,132
4/17/2010	FALSE	FALSE	FALSE	3.82	10.14	7.61	50%	38%	75%		1.33	7.5	8.5									13,868	12,866	1,132				13,868	12,866	1,132
4/18/2010	FALSE	FALSE	FALSE	3.90	10.10	8.30	47%	39%	82%		1.22	7.5	8.7									14,378	12,866	1,132				14,378	12,866	1,132
4/19/2010	FALSE	FALSE	FALSE	4.30	10.00	7.16	60%	43%	72%		1.40	7.5	8.5	190.00			17.91	11,346		1,069		14,426	12,866	1,186	11,346		1,069	14,426	12,866	1,186
4/20/2010	FALSE	FALSE	TRUE	4.40	10.20	9.40	47%	43%	92%	AvgMax	1.09	7.6	8.3	201.00				15,758				14,509	12,866	1,186	15,758			14,509	12,866	1,186
4/21/2010	FALSE	FALSE	TRUE	4.20	10.60	8.98	47%	40%	85%		1.18	7.7	8.2	220.00	162.00	0.74		16,477	12,133			14,625	12,774	1,186	16,477	12,133		14,625	12,774	1,186
4/22/2010	FALSE	FALSE	FALSE	4.80	10.10	8.82	54%	48%	87%	AvgMax	1.15	7.7	8.1									14,509	12,774	1,186				14,509	12,774	1,186
4/23/2010	FALSE	FALSE	FALSE	4.45	9.89	7.79	57%	45%	79%		1.27	7.7	8.0									14,562	12,746	1,186				14,562	12,746	1,186
4/24/2010	FALSE	FALSE	FALSE	3.90	9.98	7.50	52%	39%	75%		1.33	7.7	7.9									14,562	12,746	1,186				14,562	12,746	1,186
4/25/2010	FALSE	FALSE	FALSE	3.49	9.55	7.29	48%	37%	76%		1.31	7.7	7.8									14,494	12,746	1,163				14,494	12,746	1,163
4/26/2010	FALSE	FALSE	TRUE	3.72	9.34	7.72	48%	40%	83%		1.21	7.7	7.7	319.00				20,549			TSS	14,723	12,746	1,163	20,549			14,723	12,746	1,163
4/27/2010	FALSE	FALSE	TRUE	4.12	9.39	7.74	53%	44%	82%		1.21	7.7	7.8	221.00	166.00	0.75		14,262	10,713			14,690	12,492	1,163	14,262	10,713		14,690	12,492	1,163
4/28/2010	FALSE	FALSE	TRUE	4.06	9.65	7.97	51%	42%	83%		1.21	7.8	7.9									14,690	12,492	1,163				14,690	12,492	1,163
4/29/2010	FALSE	FALSE	TRUE			7.36				igMinMaxA	0.00	7.8	7.7				34.58			2,121	NH3	14,690	12,492	1,163			2,121	14,690	12,492	1,163
4/30/2010	FALSE	FALSE	FALSE	4.64	8.92	7.33	63%	52%	82%		1.22	7.8	7.6	181.00				11,059				14,448	12,219	1,163	11,059			14,448	12,219	1,163
5/1/2010	FALSE	FALSE	FALSE																											

Date	Butte Break?	CSU Break?	Precip?	Min Influent Flow, mgd	Max Influent Flow, mgd	Avg Influent Flow, mgd	Min % of Avg	Min % of Max	Avg % of Max	Flow Outlier Type	Diurnal Peak Factor (DPF)	30-d Avg of Avg Flow, mgd	7-d Avg of Avg Flow, mgd	Influent TSS Conc., mg/L	Influent BOD Conc., mg/L	BOD/TSS Ratio	Influent NH3-N Conc., mg/L	Avg Inf TSS Load, ppd	Avg Inf BOD Load, ppd	Avg Inf NH3 Load, ppd	Load Outlier Type	30-d Avg of TSS Load, ppd	30-d Avg of BOD Load, ppd	30-d Avg of NH3-N Load, ppd	non-SN TSS Load, ppd	non-SN BOD Load, ppd	non-SN NH3 Load, ppd	30-d Avg of non-SN TSS Load, ppd	30-d Avg of non-SN BOD Load, ppd	30-d Avg of non-SN NH3-N Load, ppd
5/14/2010	FALSE	FALSE	FALSE							igMinMaxA		7.6	6.3	184.00								13,054	11,284	1,056				13,054	11,284	1,056
5/15/2010	FALSE	FALSE	FALSE							igMinMaxA		7.5	6.3									13,054	11,284	1,056				13,054	11,284	1,056
5/16/2010	FALSE	FALSE	FALSE							igMinMaxA		7.4										12,921	11,284	1,083				12,921	11,284	1,083
5/17/2010	FALSE	FALSE	TRUE							igMinMaxA		7.4		108.00			22.90					12,573	11,168	1,083				12,573	11,168	1,083
5/18/2010	FALSE	FALSE	TRUE							igMinMaxA		7.4		221.00	190.00	0.86						12,573	11,168	1,083				12,573	11,168	1,083
5/19/2010	FALSE	FALSE	TRUE							igMinMaxA		7.3										12,573	11,168	1,083				12,573	11,168	1,083
5/20/2010	FALSE	FALSE	FALSE							igMinMaxA		7.3		190.00								12,726	11,168	1,096				12,726	11,168	1,096
5/21/2010	FALSE	FALSE	FALSE							igMinMaxA		7.3		218.00								12,293	11,168	1,096				12,293	11,168	1,096
5/22/2010	FALSE	FALSE	FALSE							igMinMaxA		7.2										11,595	10,685	1,096				11,595	10,685	1,096
5/23/2010	FALSE	TRUE	FALSE							igMinMaxA		7.2										11,595	10,685	1,096				11,595	10,685	1,096
5/24/2010	FALSE	TRUE	FALSE							igMinMaxA		7.1		195.00								11,595	10,685	1,096				11,595	10,685	1,096
5/25/2010	FALSE	TRUE	TRUE							igMinMaxA		7.1		182.00	203.00	1.12						11,595	10,685	1,096				11,595	10,685	1,096
5/26/2010	FALSE	TRUE	FALSE							igMinMaxA		7.1										11,595	10,685	1,096				11,595	10,685	1,096
5/27/2010	FALSE	TRUE	TRUE							igMinMaxA		7.0		220.00			20.92					11,595	10,685	1,096				11,595	10,685	1,096
5/28/2010	TRUE	TRUE	TRUE			6.45				igMinMaxA	0.00	6.8	#DIV/0!	270.00	261.00	0.97		14,524	14,040			11,639	12,349	1,096	14,524	14,040		11,639	12,349	1,096
5/29/2010	TRUE	TRUE	FALSE			6.16				igMinMaxA	0.00	6.6	#DIV/0!									11,639	12,349	1,096				11,639	12,349	1,096
5/30/2010	TRUE	TRUE	FALSE			5.85				igMinMaxA	0.00	6.6	#DIV/0!									11,639	12,349	1,096				11,639	12,349	1,096
5/31/2010	TRUE	TRUE	FALSE			6.21				igMinMaxA	0.00	6.4	#DIV/0!									11,755	12,349	1,096				11,755	12,349	1,096
6/1/2010	TRUE	TRUE	FALSE			6.15				igMinMaxA	0.00	6.4	#DIV/0!	184.00	183.00	0.99		9,438	9,386			11,369	11,361	1,096	9,438	9,386		11,369	11,361	1,096
6/2/2010	TRUE	TRUE	FALSE			6.33				igMinMaxA	0.00	6.3	#DIV/0!									11,369	11,361	1,096				11,369	11,361	1,096
6/3/2010	TRUE	TRUE	FALSE			6.27				igMinMaxA	0.00	6.3	#DIV/0!	188.00			20.00	9,831		1,046		11,480	11,361	1,071	9,831		1,046	11,480	11,361	1,071
6/4/2010	TRUE	TRUE	TRUE			6.17				igMinMaxA	0.00	6.3	#DIV/0!	205.00	212.00	1.03		10,549	10,909			11,347	11,248	1,071	10,549	10,909		11,347	11,248	1,071
6/5/2010	TRUE	TRUE	FALSE			5.72				igMinMaxA	0.00	6.3	#DIV/0!									11,504	11,248	1,071				11,504	11,248	1,071
6/6/2010	TRUE	TRUE	FALSE			5.98				igMinMaxA	0.00	6.3	#DIV/0!									11,424	11,248	1,046				11,424	11,248	1,046
6/7/2010	TRUE	TRUE	FALSE			6.32				igMinMaxA	0.00	6.3	#DIV/0!	163.00			20.42	8,592		1,076		10,587	11,445	1,061	8,592		1,076	10,587	11,445	1,061
6/8/2010	TRUE	TRUE	FALSE			6.29				igMinMaxA	0.00	#DIV/0!	#DIV/0!	188.00				9,862				10,466	11,445	1,061	9,862			10,466	11,445	1,061
6/9/2010	TRUE	TRUE	FALSE			6.35				igMinMaxA	0.00	#DIV/0!	#DIV/0!									10,466	11,445	1,061				10,466	11,445	1,061
6/10/2010	TRUE	TRUE	FALSE			6.24				igMinMaxA	0.00	#DIV/0!	#DIV/0!	233.00								10,703	11,445	1,061	12,126			10,703	11,445	1,061
6/11/2010	TRUE	TRUE	FALSE			6.13				igMinMaxA	0.00	#DIV/0!	#DIV/0!	229.00								10,829	11,445	1,061	11,707			10,829	11,445	1,061
6/12/2010	TRUE	TRUE	FALSE			5.88				igMinMaxA	0.00	#DIV/0!	#DIV/0!									10,829	11,445	1,061				10,829	11,445	1,061
6/13/2010	TRUE	TRUE	FALSE	3.41	7.95	5.88	58%	43%	74%		1.35	5.9	5.9									10,829	11,445	1,061				10,829	11,445	1,061
6/14/2010	TRUE	TRUE	FALSE	3.45	7.93	6.15	56%	44%	78%		1.29	6.0	6.0	180.00				9,232				10,651	11,445	1,061	9,232			10,651	11,445	1,061
6/15/2010	TRUE	TRUE	FALSE	3.46	7.98	6.22	56%	43%	78%		1.28	6.1	6.1	215.00	183.00	0.85		11,153	9,493			10,701	10,957	1,061	11,153	9,493		10,701	10,957	1,061
6/16/2010	TRUE	TRUE	FALSE	3.51	8.03	6.27	56%	44%	78%		1.28	6.1	6.1									10,701	10,957	1,061				10,701	10,957	1,061
6/17/2010	TRUE	TRUE	FALSE	3.48	8.80	6.19	56%	40%	70%		1.42	6.1	6.1				20.51			1,059		10,701	10,957	1,060			1,059	10,701	10,957	1,060
6/18/2010	TRUE	TRUE	FALSE	3.48	9.11	5.42	64%	38%	59%		1.68	6.0	6.0	190.00	161.00	0.85		8,589	7,278			10,509	10,221	1,060	8,589	7,278		10,509	10,221	1,060
6/19/2010	TRUE	TRUE	FALSE							igMinMaxA		6.0	6.0									10,509	10,221	1,060				10,509	10,221	1,060
6/20/2010	TRUE	TRUE	FALSE							igMinMaxA		6.0	6.0									10,509	10,221	1,060				10,509	10,221	1,060
6/21/2010	TRUE	TRUE	FALSE							igMinMaxA		6.0	6.1	186.00								10,509	10,221	1,060				10,509	10,221	1,060
6/22/2010	TRUE	TRUE	FALSE							igMinMaxA		6.0	6.0	199.00			16.71					10,509	10,221	1,060				10,509	10,221	1,060
6/23/2010	TRUE	TRUE	FALSE			5.88				igMinMaxA	0.00	6.0	6.0									10,509	10,221	1,060				10,509	10,221	1,060
6/24/2010	TRUE	TRUE	FALSE			5.93				igMinMaxA	0.00	6.0	5.8									10,509	10,221	1,060				10,509	10,221	1,060
6/25/2010	TRUE	TRUE	FALSE	3.37	9.06	5.90	57%	37%	65%		1.54	6.0	5.7	212.00	185.00	0.87		10,432	9,103			10,503	10,035	1,060	10,432	9,103		10,503	10,035	1,060
6/26/2010	TRUE	TRUE	FALSE			5.74				igMinMaxA	0.00	6.0	5.9									10,503	10,035	1,060				10,503	10,035	1,060
6/27/2010	TRUE	TRUE	FALSE	3.35	5.93	5.86	57%	56%	99%	inMaxAvgM	1.01	6.0	5.9									10,503	10,035	1,060				10,503	10,035	1,060
6/28/2010	TRUE	TRUE	FALSE	3.35	6.20	6.24	54%	54%	101%	AvgMax	0.99	6.0	5.9	204.00				10,616				10,177	9,234	1,060	10,616			10,177	9,234	1,060
6/29/2010	TRUE	TRUE	FALSE	3.46	6.13	6.20	56%	56%	101%	inMaxAvgM	0.99	6.0	5.9	86.00	104.00	1.21		4,447	5,378		TSS	10,177	8,591	1,060	4,447	5,378		10,177	8,591	1,060
6/30/2010	TRUE	TRUE	FALSE	3.40	6.26	6.19	55%	54%	99%	AvgMax	1.01	6.0	5.9									10,177	8,591	1,060				10,177	8,591	1,060
7/1/2010	TRUE	TRUE	FALSE	3.36	6.32	6.12	55%	53%	97%	AvgMax	1.03	6.0	5.9	172.00			20.12	8,779		1,027		10,070	8,591	1,052	8,779		1,027	10,070	8,591	1,052
7/2/2010	TRUE	TRUE	FALSE	3.39	9.40	6.02	56%	36%	64%		1.56	6.0	6.0	261.00	166.00	0.64		13,104	8,334			10,352	8,416	1,052	13,104	8,334		10,352	8,416	1,052
7/3/2010	TRUE	TRUE	FALSE	3.31	8.85	5.54	60%	37%	63%		1.60	6.0	5.8									10,352	8,416	1,052				10,352	8,416	1,052
7/4/2010	TRUE	TRUE	FALSE	3.16	8.08	5.20	61%	39%	64%		1.55	5.9	5.6									10,395	8,416	1,054				10,395	8,416	1,054
7/5/2010	TRUE	TRUE	FALSE	3.39	9.02	5.89	58%	38%	65%		1.53	5.9	5.7									10,381	7,917	1,054				10,381	7,917	1,054
7/6/2010	TRUE	TRUE	FALSE	3.35	8.99	6.06	55%	37%	67%		1.48	5.9	5.7	249.00	178.00	0.71		12,585	8,996			10,565	8,097	1,054	12,585	8,996		10,565	8,097	

Date	Butte Break?	CSU Break?	Precip?	Min Influent Flow, mgd	Max Influent Flow, mgd	Avg Influent Flow, mgd	Min % of Avg	Min % of Max	Avg % of Max	Flow Outlier Type	Diurnal Peak Factor (DPF)	30-d Avg of Avg Flow, mgd	7-d Avg of Avg Flow, mgd	Influent TSS Conc., mg/L	Influent BOD Conc., mg/L	BOD/TSS Ratio	Influent NH3-N Conc., mg/L	Avg Inf TSS Load, ppd	Avg Inf BOD Load, ppd	Avg Inf NH3 Load, ppd	Load Outlier Type	30-d Avg of TSS Load, ppd	30-d Avg of BOD Load, ppd	30-d Avg of NH3-N Load, ppd	non-SN TSS Load, ppd	non-SN BOD Load, ppd	non-SN NH3 Load, ppd	30-d Avg of non-SN TSS Load, ppd	30-d Avg of non-SN BOD Load, ppd	30-d Avg of non-SN NH3-N Load, ppd
7/16/2010	TRUE	TRUE	FALSE	3.39	9.01	5.78	59%	38%	64%		1.56	5.9	5.9	273.00	184.00	0.67		13,160	8,870			11,050	7,968	1,081	13,160	8,870		11,050	7,968	1,081
7/17/2010	TRUE	TRUE	FALSE	3.50	8.30	5.62	62%	42%	68%		1.48	5.9	5.9									11,050	7,968	1,081				11,050	7,968	1,081
7/18/2010	TRUE	TRUE	FALSE	3.10	8.50	5.60	55%	36%	66%		1.52	5.8	5.9									11,050	7,968	1,088				11,050	7,968	1,088
7/19/2010	TRUE	TRUE	FALSE	3.41	7.83	6.03	57%	44%	77%		1.30	5.9	5.9	153.00				7,694				10,976	8,067	1,088	7,694			10,976	8,067	1,088
7/20/2010	TRUE	TRUE	FALSE	3.57	7.58	6.03	59%	47%	80%		1.26	5.9	5.9	199.00	199.00	1.00		10,008	10,008			10,901	8,310	1,088	10,008	10,008		10,901	8,310	1,088
7/21/2010	TRUE	TRUE	FALSE	3.50	8.55	6.10	57%	41%	71%		1.40	5.9	5.9									10,901	8,310	1,088				10,901	8,310	1,088
7/22/2010	TRUE	TRUE	FALSE	3.48	7.11	5.96	58%	49%	84%		1.19	5.9	5.9	210.00	325.00	1.55		10,438	16,155			10,868	9,181	1,088	10,438	16,155		10,868	9,181	1,088
7/23/2010	TRUE	TRUE	FALSE	3.50	7.40	5.92	59%	47%	80%		1.25	5.9	5.9	219.00			20.71	10,813		1,023		10,865	9,181	1,072	10,785		1,023	10,863	9,181	1,072
7/24/2010	TRUE	TRUE	FALSE	3.60	7.80	5.75	63%	46%	74%		1.36	5.9	5.9									10,865	9,181	1,072				10,863	9,181	1,072
7/25/2010	TRUE	TRUE	FALSE	3.35	7.59	5.63	60%	44%	74%		1.35	5.9	5.9									10,865	9,181	1,072				10,863	9,181	1,072
7/26/2010	TRUE	TRUE	FALSE	3.39	8.09	6.07	56%	42%	75%		1.33	5.9	5.9	197.00				9,973				10,834	9,191	1,072	9,973			10,832	9,191	1,072
7/27/2010	TRUE	TRUE	FALSE	3.45	8.12	6.06	57%	42%	75%		1.34	5.9	5.9	201.00			21.90	10,159		1,107		10,792	9,191	1,079	10,159		1,107	10,790	9,191	1,079
7/28/2010	TRUE	TRUE	FALSE	3.41	8.51	6.02	57%	40%	71%		1.41	5.9	5.9	234.00				11,748				10,848	9,191	1,079	11,748			10,847	9,191	1,079
7/29/2010	TRUE	TRUE	FALSE	3.47	7.74	6.03	58%	45%	78%		1.28	5.9	5.9	233.00				11,718				10,913	9,191	1,079	11,718			10,911	9,191	1,079
7/30/2010	TRUE	TRUE	FALSE	3.45	6.32	6.01	57%	55%	95%	AvgMax	1.05	5.9	5.9	207.00	259.00	1.25		10,376	12,982			10,883	10,142	1,079	10,376	12,982		10,882	10,142	1,079
7/31/2010	TRUE	TRUE	FALSE	3.45	6.21	5.73	60%	56%	92%	inMaxAvgM	1.08	5.9	5.9									10,883	10,142	1,079				10,882	10,142	1,079
8/1/2010	TRUE	TRUE	FALSE	3.30	8.39	5.71	58%	39%	68%		1.47	5.9	5.9									11,007	10,142	1,092				11,005	10,142	1,092
8/2/2010	TRUE	TRUE	FALSE	3.38	8.79	6.03	56%	38%	69%		1.46	5.9	6.0	188.00				9,455				10,792	10,400	1,092	9,455			10,791	10,400	1,092
8/3/2010	TRUE	TRUE	FALSE	3.51	8.09	6.07	58%	43%	75%		1.33	5.9	6.0	235.00	228.00	0.97		11,897	11,542			10,853	10,543	1,092	11,897	11,542		10,852	10,543	1,092
8/4/2010	TRUE	TRUE	FALSE	3.43	8.65	6.07	57%	40%	70%		1.43	5.9	6.0									10,853	10,543	1,092				10,852	10,543	1,092
8/5/2010	TRUE	TRUE	FALSE	3.40	8.64	6.04	56%	39%	70%		1.43	5.9	6.0	248.00	280.00	1.13		12,493	14,105			10,940	10,938	1,092	12,493	14,105		10,938	10,938	1,092
8/6/2010	TRUE	TRUE	FALSE	3.42	7.74	6.02	57%	44%	78%		1.29	5.9	6.0				21.08			1,058		10,848	11,181	1,085			1,058	10,847	11,181	1,085
8/7/2010	TRUE	TRUE	FALSE	4.09	8.04	5.82	70%	51%	72%	MinAvg	1.38	5.9	6.0									10,848	11,181	1,085				10,847	11,181	1,085
8/8/2010	TRUE	TRUE	FALSE	3.38	9.52	5.86	58%	36%	62%		1.62	5.9	6.0	218.00				10,654				10,659	11,181	1,078	10,654			10,657	11,181	1,078
8/9/2010	TRUE	TRUE	FALSE	3.30	8.70	6.21	53%	38%	71%		1.40	5.9	6.0	147.00				7,613				10,400	11,342	1,078	7,613			10,399	11,342	1,078
8/10/2010	TRUE	TRUE	FALSE	3.43	6.65	6.27	55%	52%	94%	AvgMax	1.06	5.9	6.0	128.00	181.00	1.41		6,693	9,465			10,205	11,107	1,078	6,693	9,465		10,204	11,107	1,078
8/11/2010	TRUE	TRUE	FALSE	3.33	6.65	6.30	53%	50%	95%	AvgMax	1.06	6.0	6.0									10,205	11,107	1,078				10,204	11,107	1,078
8/12/2010	TRUE	TRUE	FALSE	3.33	6.67	6.32	53%	50%	95%	AvgMax	1.06	6.0	6.0	136.00			20.15	7,168		1,062		10,072	11,107	1,075	7,168		1,062	10,070	11,107	1,075
8/13/2010	TRUE	TRUE	FALSE	3.40	8.20	6.03	56%	41%	74%		1.36	5.9	6.0	692.00	403.00	0.58		34,801	20,267		TSS	10,274	12,924	1,075	34,801	20,267		10,272	12,924	1,075
8/14/2010	TRUE	TRUE	FALSE	3.30	8.60	5.93	56%	38%	69%		1.45	5.9	6.0									10,274	12,924	1,075				10,272	12,924	1,075
8/15/2010	TRUE	TRUE	FALSE	3.26	8.59	6.09	54%	38%	71%		1.41	5.9	6.0									10,121	12,924	1,062				10,120	12,924	1,062
8/16/2010	TRUE	TRUE	FALSE	3.45	7.28	6.34	54%	47%	87%	AvgMax	1.15	6.0	6.1	168.00				8,883				9,870	13,503	1,062	8,883			9,868	13,503	1,062
8/17/2010	TRUE	TRUE	FALSE	3.33	8.62	6.34	53%	39%	74%		1.36	6.0	6.1	404.00	200.00	0.50		21,362	10,575		TSS	9,870	13,137	1,062	21,362	10,575		9,868	13,137	1,062
8/18/2010	TRUE	TRUE	FALSE	3.46	6.77	6.38	54%	51%	94%	AvgMax	1.06	6.0	6.1									9,870	13,137	1,062				9,868	13,137	1,062
8/19/2010	TRUE	TRUE	FALSE	3.41	8.18	6.40	53%	42%	78%		1.28	6.0	6.2	188.00			20.22	10,035		1,079		10,007	13,137	1,066	10,035		1,079	10,006	13,137	1,066
8/20/2010	TRUE	TRUE	FALSE	3.42	9.28	6.42	53%	37%	69%		1.45	6.0	6.2	223.00	124.00	0.56		11,940	6,639			10,121	12,716	1,066	11,940	6,639		10,119	12,716	1,066
8/21/2010	TRUE	TRUE	FALSE	3.41	10.19	6.31	54%	33%	62%		1.61	6.0	6.2									10,121	12,716	1,066				10,119	12,716	1,066
8/22/2010	TRUE	TRUE	FALSE	3.41	9.02	6.35	54%	38%	70%		1.42	6.1	6.3									10,101	12,225	1,066				10,099	12,225	1,066
8/23/2010	TRUE	TRUE	FALSE	3.35	6.94	6.45	52%	48%	93%	AvgMax	1.08	6.1	6.4	154.00				8,284				9,943	12,225	1,077	8,284			9,943	12,225	1,077
8/24/2010	FALSE	FALSE	FALSE	3.43	9.72	6.45	53%	35%	66%		1.51	6.1	6.4	171.00				9,199				9,899	12,225	1,077	9,199			9,899	12,225	1,077
8/25/2010	FALSE	FALSE	FALSE	3.32	9.84	6.56	51%	34%	67%		1.50	6.1	6.4									9,899	12,225	1,077				9,899	12,225	1,077
8/26/2010	FALSE	FALSE	FALSE	3.32	9.79	6.53	51%	34%	67%		1.50	6.2	6.4	184.00			21.18	10,021		1,153		9,902	12,225	1,092	10,021		1,153	9,902	12,225	1,092
8/27/2010	FALSE	FALSE	FALSE	3.52	6.73	5.08	69%	52%	75%		1.32	6.1	6.2	259.00				10,973				9,950	12,225	1,088	10,973			9,950	12,225	1,088
8/28/2010	FALSE	FALSE	FALSE			4.48				rgMinMaxA	0.00	6.1	6.2									9,838	12,225	1,088				9,838	12,225	1,088
8/29/2010	FALSE	FALSE	FALSE	3.01	6.30	4.44	68%	48%	70%		1.42	6.0	5.9									9,712	12,225	1,088				9,712	12,225	1,088
8/30/2010	FALSE	FALSE	FALSE	3.26	9.85	6.57	50%	33%	67%		1.50	6.1	5.9	160.00				8,767				9,605	12,099	1,088	8,767			9,605	12,099	1,088
8/31/2010	FALSE	FALSE	FALSE	3.36	8.06	6.53	51%	42%	81%		1.23	6.1	6.0	182.00				9,912				9,624	12,099	1,088	9,844			9,620	12,099	1,088
9/1/2010	FALSE	FALSE	FALSE	3.26	7.68	6.50	50%	42%	85%		1.18	6.1	6.0	190.00				10,300				9,664	12,099	1,088	10,300			9,660	12,099	1,088
9/2/2010	FALSE	FALSE	FALSE	3.37	6.39	6.68	50%	53%	105%	AvgMax	0.96	6.1	5.9	202.00			20.19	11,254		1,125		9,770	12,099	1,096	11,254		1,125	9,766	12,099	1,096
9/3/2010	FALSE	FALSE	FALSE	3.42	9.82	6.53	52%	35%	66%		1.50</																			

Date	Butte Break?	CSU Break?	Precip?	Min Influent Flow, mgd	Max Influent Flow, mgd	Avg Influent Flow, mgd	Min % of Avg	Min % of Max	Avg % of Max	Flow Outlier Type	Diurnal Peak Factor (DPF)	30-d Avg of Avg Flow, mgd	7-d Avg of Avg Flow, mgd	Influent TSS Conc., mg/L	Influent BOD Conc., mg/L	BOD/TSS Ratio	Influent NH3-N Conc., mg/L	Avg Inf TSS Load, ppd	Avg Inf BOD Load, ppd	Avg Inf NH3 Load, ppd	Load Outlier Type	30-d Avg of TSS Load, ppd	30-d Avg of BOD Load, ppd	30-d Avg of NH3-N Load, ppd	non-SN TSS Load, ppd	non-SN BOD Load, ppd	non-SN NH3 Load, ppd	30-d Avg of non-SN TSS Load, ppd	30-d Avg of non-SN BOD Load, ppd	30-d Avg of non-SN NH3-N Load, ppd
9/17/2010	FALSE	FALSE	FALSE	2.23	10.24	6.57	34%	22%	64%	inAvgMinM	1.56	6.4	6.6	224.00	256.00	1.14		12,274	14,027			11,323	10,591	1,154	12,274	14,027		11,319	10,591	1,154
9/18/2010	FALSE	FALSE	FALSE	2.15	10.03	6.32	34%	21%	63%	inAvgMinM	1.59	6.4	6.5									11,323	10,591	1,154				11,319	10,591	1,154
9/19/2010	FALSE	FALSE	TRUE	3.37	9.80	6.44	52%	34%	66%		1.52	6.4	6.5									11,403	10,591	1,173				11,399	10,591	1,173
9/20/2010	FALSE	FALSE	TRUE	3.31	9.72	6.66	50%	34%	69%		1.46	6.4	6.6	144.00				7,998				11,157	12,567	1,173	7,998			11,153	12,567	1,173
9/21/2010	FALSE	FALSE	FALSE	3.38	9.45	6.65	51%	36%	70%		1.42	6.4	6.6	215.00	185.00	0.86		11,924	10,260			11,202	11,798	1,173	11,924	10,260		11,198	11,798	1,173
9/22/2010	FALSE	FALSE	FALSE	3.36	9.38	6.62	51%	36%	71%		1.42	6.4	6.6									11,202	11,798	1,173				11,198	11,798	1,173
9/23/2010	FALSE	FALSE	FALSE	3.33	9.41	6.54	51%	35%	70%		1.44	6.4	6.6	214.00			20.22	11,672		1,103		11,401	11,798	1,159	11,672		1,103	11,397	11,798	1,159
9/24/2010	FALSE	FALSE	FALSE	3.40	9.20	6.50	52%	37%	71%		1.42	6.4	6.6	162.00	229.00	1.41		8,782	12,414			11,377	11,952	1,159	8,782	12,414		11,373	11,952	1,159
9/25/2010	FALSE	FALSE	FALSE	3.40	9.30	6.22	55%	37%	67%		1.50	6.4	6.5									11,377	11,952	1,159				11,373	11,952	1,159
9/26/2010	FALSE	FALSE	FALSE	3.31	8.79	6.21	53%	38%	71%		1.42	6.4	6.5									11,462	11,952	1,160				11,457	11,952	1,160
9/27/2010	FALSE	FALSE	FALSE	3.40	9.20	6.54	52%	37%	71%		1.41	6.4	6.5	192.00				10,472				11,430	11,952	1,160	10,339			11,418	11,952	1,160
9/28/2010	FALSE	FALSE	FALSE	3.38	9.57	6.54	52%	35%	68%		1.46	6.4	6.5	236.00	194.00	0.82		12,872	10,581			11,515	11,678	1,160	12,872	10,581		11,503	11,678	1,160
9/29/2010	FALSE	FALSE	FALSE	3.41	9.52	6.53	52%	36%	69%		1.46	6.5	6.5									11,515	11,678	1,160				11,503	11,678	1,160
9/30/2010	FALSE	FALSE	FALSE	3.35	9.73	6.69	50%	34%	69%		1.45	6.5	6.5				23.91			1,334		11,687	11,678	1,195			1,334	11,674	11,678	1,195
10/1/2010	FALSE	FALSE	FALSE	3.41	9.74	6.44	53%	35%	66%		1.51	6.5	6.5	263.00				14,126				11,950	11,678	1,195	14,126			11,942	11,678	1,195
10/2/2010	FALSE	FALSE	FALSE	3.31	9.77	6.24	53%	34%	64%		1.57	6.5	6.4									12,060	11,678	1,195				12,051	11,678	1,195
10/3/2010	FALSE	FALSE	FALSE	3.30	9.80	6.36	52%	34%	65%		1.54	6.5	6.4									12,118	11,678	1,213				12,108	11,678	1,213
10/4/2010	FALSE	FALSE	FALSE	3.30	9.40	6.78	49%	35%	72%		1.39	6.5	6.5	181.00								11,989	11,678	1,213	10,235			11,980	11,678	1,213
10/5/2010	FALSE	FALSE	FALSE	3.40	9.40	7.71	44%	36%	82%		1.22	6.6	6.7	225.00				14,468				12,155	11,678	1,213	14,468			12,146	11,678	1,213
10/6/2010	FALSE	FALSE	TRUE	3.30	9.30	6.81	48%	35%	73%		1.37	6.6	6.7									12,155	11,678	1,213				12,146	11,678	1,213
10/7/2010	FALSE	FALSE	FALSE	3.40	9.40	6.72	51%	36%	71%		1.40	6.6	6.7	212.00			17.69	11,881		991		12,137	11,678	1,168	11,881		991	12,129	11,678	1,168
10/8/2010	FALSE	FALSE	FALSE	3.30	9.30	6.65	50%	35%	72%		1.40	6.6	6.7	216.00	211.00	0.98		11,980	11,702			12,128	11,682	1,168	11,980	11,702		12,120	11,682	1,168
10/9/2010	FALSE	FALSE	FALSE	3.39	9.48	6.40	53%	36%	68%		1.48	6.6	6.7									11,871	11,682	1,168				11,862	11,682	1,168
10/10/2010	FALSE	FALSE	FALSE	3.48	9.37	5.94	59%	37%	63%		1.58	6.6	6.7									11,731	11,682	1,169				11,722	11,682	1,169
10/11/2010	FALSE	FALSE	FALSE	3.41	9.36	6.70	51%	36%	72%		1.40	6.6	6.7	191.00			25.65	10,673		1,433		11,627	11,797	1,222	10,673		1,433	11,618	11,797	1,222
10/12/2010	FALSE	FALSE	FALSE	3.44	9.28	6.69	51%	37%	72%		1.39	6.6	6.7	198.00	232.00	1.17		11,047	12,944			11,591	11,988	1,222	11,047	12,944		11,582	11,988	1,222
10/13/2010	FALSE	FALSE	FALSE	3.43	9.29	6.70	51%	37%	72%		1.39	6.6	6.6									11,591	11,988	1,222				11,582	11,988	1,222
10/14/2010	FALSE	FALSE	FALSE	3.48	9.40	6.74	52%	37%	72%		1.39	6.6	6.6	230.00				12,929				11,756	11,988	1,222	12,929			11,748	11,988	1,222
10/15/2010	FALSE	FALSE	FALSE	3.41	9.40	6.66	51%	36%	71%		1.41	6.6	6.6	256.00				14,219				11,901	11,988	1,222	14,219			11,893	11,988	1,222
10/16/2010	FALSE	FALSE	FALSE	3.34	9.97	6.43	52%	34%	64%		1.55	6.6	6.5									11,722	11,988	1,222				11,714	11,988	1,222
10/17/2010	FALSE	FALSE	TRUE	3.39	10.56	6.66	51%	32%	63%		1.59	6.6	6.6									11,722	11,988	1,215				11,714	11,988	1,215
10/18/2010	FALSE	FALSE	FALSE	3.40	9.86	6.85	50%	34%	69%		1.44	6.6	6.7	219.00				12,511				11,737	11,580	1,215	12,511			11,729	11,580	1,215
10/19/2010	FALSE	FALSE	FALSE	3.35	10.37	6.76	50%	32%	65%		1.53	6.6	6.7	246.00	230.00	0.93		13,869	12,967			11,862	11,812	1,215	13,869	12,967		11,854	11,812	1,215
10/20/2010	FALSE	FALSE	FALSE	3.37	9.83	6.74	50%	34%	69%		1.46	6.6	6.7									11,862	11,812	1,215				11,854	11,812	1,215
10/21/2010	FALSE	FALSE	FALSE	3.39	9.98	7.30	46%	34%	73%		1.37	6.6	6.8	261.00			23.63	15,890		1,439		12,327	11,812	1,260	15,890		1,439	12,319	11,812	1,260
10/22/2010	FALSE	FALSE	TRUE	3.41	9.97	6.64	51%	34%	67%		1.50	6.6	6.8	245.00	225.00	0.92		13,568	12,460			12,423	12,178	1,260	13,568	12,460		12,415	12,178	1,260
10/23/2010	FALSE	FALSE	TRUE	3.50	11.07	6.91	51%	32%	62%		1.60	6.6	6.8									12,423	12,178	1,260				12,415	12,178	1,260
10/24/2010	FALSE	FALSE	TRUE	3.51	12.87	8.39	42%	27%	65%	MinAvg	1.53	6.6	6.8									12,470	12,178	1,299				12,462	12,178	1,299
10/25/2010	FALSE	FALSE	FALSE	3.66	11.32	7.71	47%	32%	68%		1.47	6.7	7.0									12,716	12,131	1,299				12,707	12,131	1,299
10/26/2010	FALSE	FALSE	FALSE	3.54	10.45	7.26	49%	34%	69%		1.44	6.7	7.0	199.00	201.00	1.01		12,049	12,170			12,674	12,138	1,299	12,049	12,170		12,666	12,138	1,299
10/27/2010	FALSE	FALSE	TRUE	3.44	10.69	7.41	46%	32%	69%		1.44	6.8	7.1									12,674	12,138	1,299				12,666	12,138	1,299
10/28/2010	FALSE	FALSE	FALSE	3.44	10.23	7.01	49%	34%	69%		1.46	6.8	7.2	242.00			26.57	14,148		1,553		12,904	12,138	1,350	14,148		1,553	12,904	12,138	1,350
10/29/2010	FALSE	FALSE	TRUE	3.58	10.23	7.21	50%	35%	70%		1.42	6.8	7.2	177.00				10,643				12,765	12,449	1,350	10,643			12,765	12,449	1,350
10/30/2010	FALSE	FALSE	TRUE	3.64	10.33	7.22	50%	35%	70%		1.43	6.8	7.2									12,765	12,449	1,350				12,765	12,449	1,350
10/31/2010	FALSE	FALSE	FALSE	3.43	10.97	6.84	50%	31%	62%		1.60	6.8	7.2									12,765	12,449	1,354				12,765	12,449	1,354
11/1/2010	FALSE	FALSE	FALSE	3.40	9.99	6.90	49%	34%	69%		1.45	6.8	7.2	138.00				7,941				12,378	12,449	1,354	7,941			12,378	12,449	1,354
11/2/2010	FALSE	FALSE	FALSE	3.38	9.95	6.85	49%	34%	69%		1.45	6.9	7.1	238.00	200.00	0.84		13,597	11,426			12,450	12,278	1,354	13,597	11,426		12,450	12,278	1,354
11/3/2010	FALSE	FALSE	FALSE	3.44	9.81	6.80	51%	35%	69%		1.44	6.9	7.0									12,450	12,278	1,354				12,450	12,278	1,354
11/4/2010	FALSE	FALSE	FALSE	3.42	10.08	6.77	51%	34%	67%		1.49	6.9	7.0	224.00			25.23	12,647		1,425		12,592	12,278	1,368	12,647		1,425	12,592	12,278	1,368
11/5/2010	FALSE	FALSE	FALSE	3.40	9.80	6.67	51%	35																						

Date	Butte Break?	CSU Break?	Precip?	Min Influent Flow, mgd	Max Influent Flow, mgd	Avg Influent Flow, mgd	Min % of Avg	Min % of Max	Avg % of Max	Flow Outlier Type	Diurnal Peak Factor (DPF)	30-d Avg of Avg Flow, mgd	7-d Avg of Avg Flow, mgd	Influent TSS Conc., mg/L	Influent BOD Conc., mg/L	BOD/TSS Ratio	Influent NH3-N Conc., mg/L	Avg Inf TSS Load, ppd	Avg Inf BOD Load, ppd	Avg Inf NH3 Load, ppd	Load Outlier Type	30-d Avg of TSS Load, ppd	30-d Avg of BOD Load, ppd	30-d Avg of NH3-N Load, ppd	non-SN TSS Load, ppd	non-SN BOD Load, ppd	non-SN NH3 Load, ppd	30-d Avg of non-SN TSS Load, ppd	30-d Avg of non-SN BOD Load, ppd	30-d Avg of non-SN NH3-N Load, ppd
11/19/2010	FALSE	TRUE	TRUE	3.42	10.12	6.52	52%	34%	64%		1.55	6.9	6.5	212.00				11,528				12,495	11,719	1,418	11,528			12,416	11,719	1,418
11/20/2010	FALSE	TRUE	TRUE	3.33	11.03	7.22	46%	30%	65%		1.53	7.0	6.6									12,495	11,719	1,418			12,416	11,719	1,418	
11/21/2010	FALSE	TRUE	FALSE	3.65	10.92	7.00	52%	33%	64%		1.56	6.9	6.7									12,269	11,719	1,411			12,184	11,719	1,411	
11/22/2010	FALSE	TRUE	FALSE	3.67	10.06	6.74	54%	36%	67%		1.49	6.9	6.7	197.00			19.16	11,074		1,077		12,102	11,571	1,327	11,074		1,077	12,018	11,571	1,327
11/23/2010	FALSE	TRUE	FALSE	3.39	9.77	6.57	52%	35%	67%		1.49	6.9	6.7	198.00				10,849				12,024	11,571	1,327	10,849			11,945	11,571	1,327
11/24/2010	TRUE	TRUE	FALSE	3.45	9.79	6.46	53%	35%	66%		1.52	6.9	6.7	200.00	211.00	1.06		10,775	11,368			11,951	11,537	1,327	10,775	11,368	11,876	11,537	1,327	
11/25/2010	TRUE	TRUE	FALSE	3.34	9.95	5.68	59%	34%	57%	AvgMax	1.75	6.9	6.7									11,951	11,537	1,327			11,876	11,537	1,327	
11/26/2010	TRUE	TRUE	FALSE	3.34	9.13	5.87	57%	37%	64%		1.56	6.8	6.6									11,944	11,411	1,327			11,865	11,411	1,327	
11/27/2010	TRUE	TRUE	TRUE	3.53	10.60	6.65	53%	33%	63%		1.59	6.8	6.6									11,944	11,411	1,327			11,865	11,411	1,327	
11/28/2010	TRUE	TRUE	TRUE	3.43	10.50	6.75	51%	33%	64%		1.56	6.8	6.6									11,798	11,411	1,252			11,713	11,411	1,252	
11/29/2010	TRUE	TRUE	FALSE	3.44	9.83	6.85	50%	35%	70%		1.44	6.8	6.6	160.00	143.00	0.89		9,141	8,169			11,697	10,871	1,252	9,141	8,169	11,613	10,871	1,252	
11/30/2010	FALSE	FALSE	FALSE	3.53	10.24	6.89	51%	34%	67%		1.49	6.8	6.6	240.00	195.00	0.81		13,791	11,205			11,828	10,918	1,252	13,791	11,205	11,749	10,918	1,252	
12/1/2010	FALSE	FALSE	FALSE	3.39	9.90	6.75	50%	34%	68%		1.47	6.8	6.6									11,828	10,918	1,252			11,749	10,918	1,252	
12/2/2010	FALSE	FALSE	TRUE	3.42	9.80	6.89	50%	35%	70%		1.42	6.8	6.7	267.00			26.30	15,343		1,511		12,291	10,918	1,317	15,343		1,511	12,212	10,918	1,317
12/3/2010	FALSE	FALSE	TRUE	3.47	10.61	7.35	47%	33%	69%		1.44	6.8	6.8	264.00	200.00	0.76		16,183	12,260			12,452	11,038	1,317	16,183	12,260	12,373	11,038	1,317	
12/4/2010	FALSE	FALSE	TRUE	3.60	10.98	7.17	50%	33%	65%		1.53	6.8	6.9									12,452	11,038	1,317			12,373	11,038	1,317	
12/5/2010	FALSE	FALSE	TRUE	3.75	12.64	8.84	42%	30%	70%		1.43	6.9	7.2									12,439	11,038	1,281			12,355	11,038	1,281	
12/6/2010	FALSE	FALSE	TRUE	2.76	13.13	9.34	30%	21%	71%	inAvgMinM	1.41	6.9	7.2									12,390	10,949	1,281			12,300	10,949	1,281	
12/7/2010	FALSE	FALSE	FALSE	4.12	11.76	7.90	52%	35%	67%		1.49	6.9	7.4	191.00	170.00	0.89	21.53	12,584	11,201	1,419		12,403	10,985	1,315	12,584	11,201	1,419	12,319	10,985	1,315
12/8/2010	FALSE	FALSE	TRUE	4.04	11.60	8.27	49%	35%	71%		1.40	6.9	7.6									12,403	10,985	1,315			12,319	10,985	1,315	
12/9/2010	FALSE	FALSE	TRUE	3.97	11.84	8.10	49%	34%	68%		1.46	6.9	7.8	198.00				13,376				12,434	10,985	1,336	13,376		12,349	10,985	1,336	
12/10/2010	FALSE	FALSE	FALSE	3.79	11.13	7.73	49%	34%	69%		1.44	7.0	7.9	164.00	196.00	1.20		10,573	12,636			12,288	11,276	1,336	10,573	12,636	12,204	11,276	1,336	
12/11/2010	FALSE	FALSE	FALSE	3.70	11.49	7.34	50%	32%	64%		1.57	7.0	7.9									12,288	11,276	1,336			12,204	11,276	1,336	
12/12/2010	FALSE	FALSE	FALSE	3.55	11.13	7.19	49%	32%	65%		1.55	7.0	7.9									12,288	11,276	1,336			12,204	11,276	1,336	
12/13/2010	FALSE	FALSE	TRUE	3.59	10.34	7.19	50%	35%	70%		1.44	7.0	7.7	139.00				8,335				12,026	11,276	1,336	8,335		11,941	11,276	1,336	
12/14/2010	FALSE	FALSE	TRUE	3.71	10.68	7.54	49%	35%	71%		1.42	7.0	7.7	186.00	206.00	1.11		11,696	12,954			12,005	11,485	1,336	11,696	12,954	11,926	11,485	1,336	
12/15/2010	FALSE	FALSE	FALSE	3.58	10.68	7.40	48%	34%	69%		1.44	7.1	7.6									12,005	11,485	1,336			11,926	11,485	1,336	
12/16/2010	FALSE	FALSE	FALSE	3.54	10.34	7.23	49%	34%	70%		1.43	7.1	7.5				24.16			1,457		12,080	11,485	1,366		1,457	11,996	11,485	1,366	
12/17/2010	TRUE	TRUE	TRUE	3.51	10.50	7.49	47%	33%	71%		1.40	7.1	7.4	211.00				13,180				12,149	11,485	1,366	13,180		12,070	11,485	1,366	
12/18/2010	TRUE	TRUE	TRUE	3.92	12.33	7.92	49%	32%	64%		1.56	7.2	7.4									12,087	11,399	1,366			12,003	11,399	1,366	
12/19/2010	TRUE	TRUE	TRUE	4.05	13.04	8.33	49%	31%	64%		1.57	7.2	7.5									12,031	11,399	1,366			12,031	11,399	1,366	
12/20/2010	TRUE	TRUE	TRUE	6.39	10.70	8.30	77%	60%	78%	inAvgMinM	1.29	7.3	7.6	150.00				10,383				11,949	11,399	1,366	10,383		11,949	11,399	1,366	
12/21/2010	TRUE	TRUE	TRUE	6.30	11.65	8.95	70%	54%	77%	MinAvg	1.30	7.3	7.7	151.00			9.85	11,271		735		11,904	11,399	1,240	11,271		735	11,904	11,399	1,240
12/22/2010	TRUE	TRUE	TRUE	6.39	14.34	9.90	65%	45%	69%		1.45	7.4	8.0	145.00	143.00	0.99		11,972	11,807			11,908	11,450	1,240	11,972	11,807	11,908	11,450	1,240	
12/23/2010	TRUE	TRUE	TRUE	5.87	13.90	8.49	69%	42%	61%		1.64	7.4	8.2									11,964	11,450	1,280			11,964	11,450	1,280	
12/24/2010	TRUE	TRUE	FALSE	3.96	8.59	7.62	52%	46%	89%	AvgMax	1.13	7.5	8.4									12,043	11,450	1,280			12,043	11,450	1,280	
12/25/2010	TRUE	TRUE	TRUE	3.75	8.74	8.33	45%	43%	95%	AvgMax	1.05	7.5	8.7									12,141	11,462	1,280			12,141	11,462	1,280	
12/26/2010	TRUE	TRUE	FALSE	4.40	12.50	8.80	50%	35%	70%		1.42	7.6	8.9									12,141	11,462	1,280			12,141	11,462	1,280	
12/27/2010	TRUE	TRUE	FALSE	4.90	8.80	8.46	58%	56%	96%	inMaxAvgM	1.04	7.6	9.1	139.00				9,807				11,974	11,462	1,280	9,807		11,944	11,462	1,280	
12/28/2010	TRUE	TRUE	TRUE	3.90	15.30	9.69	40%	25%	63%	MinAvg	1.58	7.7	9.1	152.00				12,284				11,995	11,462	1,280	12,284		11,966	11,462	1,280	
12/29/2010	TRUE	TRUE	FALSE	6.70	14.10	10.07	67%	48%	71%		1.40	7.8	9.3	154.00	143.00	0.93		12,934	12,010			12,053	11,530	1,280	12,934	12,010	12,027	11,530	1,280	
12/30/2010	TRUE	TRUE	FALSE	4.90	12.50	8.78	56%	39%	70%		1.42	7.9	9.0	150.00			10.68	10,984		782		12,168	12,010	1,181	10,984		782	12,142	12,010	1,181
12/31/2010	TRUE	TRUE	FALSE	4.91	12.58	7.82	63%	39%	62%		1.61	7.9	8.9									12,060	12,144	1,181			12,032	12,144	1,181	
1/1/2011	TRUE	TRUE	FALSE	4.41	12.15	7.98	55%	36%	66%		1.52	8.0	8.7									12,060	12,144	1,181			12,032	12,144	1,181	
1/2/2011	TRUE	TRUE	FALSE	4.40	13.00	8.87	50%	34%	68%		1.47	8.1	8.7									11,826	12,144	1,098			11,796	12,144	1,098	
1/3/2011	TRUE	TRUE	FALSE	4.49	11.68	8.47	53%	38%	73%		1.38	8.1	8.7	168.00				11,867				11,518	12,121	1,098	11,867		11,487	12,121	1,098	
1/4/2011	TRUE	TRUE	FALSE	4.45	10.91	8.04	55%	41%	74%		1.36	8.2	8.6	175.00			17.18	11,734		1,152		11,532	12,121	1,109	11,734		1,152	11,504	12,121	1,109
1/5/2011	TRUE	TRUE	FALSE	3.65	10.98	7.64	48%	33%	70%		1.44	8.1	8.5	185.00				11,788				11,548	12,121	1,109	11,788		11,522	12,121	1,109	
1/6/2011	TRUE	TRUE	TRUE	3.92	10.86	7.56	52%	36%	70%		1.44	8.1	8.1	174.00	200.00	1.15		10,971	12,610			11,514	12,203	1,109	10,971	12,610	11,489	12,203	1,109	
1/7/2011	TRUE	TRUE	TRUE	3.80	10.70	7.30	52%	36%	68%		1.47	8.1	8.0	162.00				9,863				11,354	12,403	1,032	9,863		11,3			

Date	Butte Break?	CSU Break?	Precip?	Min Influent Flow, mgd	Max Influent Flow, mgd	Avg Influent Flow, mgd	Min % of Avg	Min % of Max	Avg % of Max	Flow Outlier Type	Diurnal Peak Factor (DPF)	30-d Avg of Avg Flow, mgd	7-d Avg of Avg Flow, mgd	Influent TSS Conc., mg/L	Influent BOD Conc., mg/L	BOD/TSS Ratio	Influent NH3-N Conc., mg/L	Avg Inf TSS Load, ppd	Avg Inf BOD Load, ppd	Avg Inf NH3 Load, ppd	Load Outlier Type	30-d Avg of TSS Load, ppd	30-d Avg of BOD Load, ppd	30-d Avg of NH3-N Load, ppd	non-SN TSS Load, ppd	non-SN BOD Load, ppd	non-SN NH3 Load, ppd	30-d Avg of non-SN TSS Load, ppd	30-d Avg of non-SN BOD Load, ppd	30-d Avg of non-SN NH3-N Load, ppd
1/21/2011	TRUE	TRUE	FALSE	3.56	10.23	7.01	51%	35%	69%		1.46	7.7	7.1	210.00	257.00	1.22		12,277	15,025			11,848	14,159	970	12,277	15,025		11,823	14,159	970
1/22/2011	TRUE	TRUE	FALSE	3.56	10.76	6.94	51%	33%	64%		1.55	7.6	7.0									11,840	14,630	970				11,814	14,630	970
1/23/2011	TRUE	TRUE	FALSE	3.62	10.97	7.05	51%	33%	64%		1.56	7.6	7.0									11,840	14,630	970				11,814	14,630	970
1/24/2011	TRUE	TRUE	FALSE	3.44	10.77	7.10	48%	32%	66%		1.52	7.6	7.0	206.00				12,198				11,861	14,630	970	12,198			11,836	14,630	970
1/25/2011	FALSE	FALSE	FALSE	3.58	10.95	7.01	51%	33%	64%		1.56	7.5	7.0	185.00	228.00	1.23		10,816	13,330			11,803	14,413	970	10,816	13,330		11,780	14,413	970
1/26/2011	FALSE	FALSE	FALSE	3.57	10.71	7.05	51%	33%	66%		1.52	7.5	7.0									11,803	14,413	970				11,780	14,413	970
1/27/2011	FALSE	FALSE	TRUE	3.46	10.50	6.94	50%	33%	66%		1.51	7.5	7.0				24.15			1,398		11,921	14,413	1,056			1,398	11,921	14,413	1,056
1/28/2011	FALSE	FALSE	TRUE	3.50	10.55	6.97	50%	33%	66%		1.51	7.5	7.0	238.00	283.00	1.19		13,835	16,451			12,012	14,704	1,056	13,835	16,451		12,012	14,704	1,056
1/29/2011	FALSE	FALSE	TRUE	3.50	10.73	6.97	50%	33%	65%		1.54	7.4	7.0									11,954	15,153	1,056				11,954	15,153	1,056
1/30/2011	FALSE	FALSE	TRUE	3.50	10.60	7.06	50%	33%	67%		1.50	7.3	7.0									12,019	15,153	1,124				12,019	15,153	1,124
1/31/2011	FALSE	FALSE	FALSE	3.60	11.20	7.11	51%	32%	63%		1.58	7.3	7.0	176.00				10,436				11,920	15,153	1,124	10,436			11,920	15,153	1,124
2/1/2011	FALSE	FALSE	FALSE	3.60	11.00	7.03	51%	33%	64%		1.56	7.2	7.0	200.00	286.00	1.43		11,726	16,768			11,909	15,384	1,124	11,726	16,768		11,909	15,384	1,124
2/2/2011	FALSE	FALSE	FALSE	3.50	7.50	6.96	50%	47%	93%	AvgMax	1.08	7.2	7.0									11,909	15,384	1,124				11,909	15,384	1,124
2/3/2011	FALSE	FALSE	FALSE	3.70	10.60	7.12	52%	35%	67%		1.49	7.1	7.0	255.00			17.30	15,142		1,027		12,101	15,384	1,105	15,142		1,027	12,101	15,384	1,105
2/4/2011	FALSE	FALSE	FALSE	3.60	11.85	6.75	53%	30%	57%	AvgMax	1.76	7.1	7.0	297.00	344.00	1.16		16,720	19,365			12,394	15,882	1,093	16,720	19,365		12,394	15,882	1,093
2/5/2011	FALSE	FALSE	FALSE	3.44	10.72	6.63	52%	32%	62%		1.62	7.1	7.0									12,432	15,882	1,093				12,432	15,882	1,093
2/6/2011	FALSE	FALSE	FALSE	3.34	7.56	6.49	51%	44%	86%	AvgMax	1.16	7.1	7.0									12,530	16,349	1,093				12,530	16,349	1,093
2/7/2011	FALSE	FALSE	FALSE	3.34	6.63	6.63	50%	50%	100%	AvgMax	1.00	7.0	7.0	227.00				12,552				12,709	16,349	1,093	12,552			12,709	16,349	1,093
2/8/2011	FALSE	FALSE	FALSE	3.38	6.92	6.67	51%	49%	96%	AvgMax	1.04	7.0	6.9	200.00				11,126				12,610	16,349	1,093	11,126			12,610	16,349	1,093
2/9/2011	FALSE	FALSE	FALSE	3.33	6.67	6.54	51%	50%	98%	AvgMax	1.02	7.0	6.9	220.00	276.00	1.25		12,000	15,054			12,574	16,187	1,093	12,000	15,054		12,574	16,187	1,093
2/10/2011	FALSE	FALSE	FALSE	3.35	6.44	6.37	53%	52%	99%	AvgMax	1.01	7.0	6.9				21.73			1,154		12,531	16,187	1,105			1,154	12,531	16,187	1,105
2/11/2011	FALSE	FALSE	FALSE	3.46	9.88	6.42	54%	35%	65%		1.54	7.0	6.5	209.00	255.00	1.22		11,190	13,653			12,452	15,906	1,105	11,190	13,653		12,452	15,906	1,105
2/12/2011	FALSE	FALSE	FALSE	3.55	9.39	6.38	56%	38%	68%		1.47	7.0	6.5									12,454	15,906	1,105				12,454	15,906	1,105
2/13/2011	FALSE	FALSE	FALSE	3.31	9.72	6.41	52%	34%	66%		1.52	6.9	6.4									12,401	15,771	1,105				12,401	15,771	1,105
2/14/2011	FALSE	FALSE	TRUE	3.52	9.58	6.97	51%	37%	73%		1.37	6.9	6.5	222.00				12,905				12,445	15,771	1,156	12,905			12,445	15,771	1,156
2/15/2011	FALSE	FALSE	TRUE	3.49	11.06	7.52	46%	32%	68%		1.47	7.0	6.7	217.00	285.00	1.31		13,610	17,874			12,518	16,004	1,156	13,610	17,874		12,518	16,004	1,156
2/16/2011	FALSE	FALSE	TRUE	3.88	11.71	8.41	46%	33%	72%		1.39	7.0	7.0									12,518	16,004	1,156				12,518	16,004	1,156
2/17/2011	FALSE	FALSE	TRUE	4.24	13.82	10.04	42%	31%	73%		1.38	7.1	7.5	209.00			16.75	17,500		1,403		12,811	16,004	1,206	17,500		1,403	12,811	16,004	1,206
2/18/2011	FALSE	FALSE	TRUE	5.21	9.76	9.50	55%	53%	97%	AvgMax	1.03	7.1	7.5	234.00	237.00	1.01		18,540	18,778			13,175	16,255	1,206	18,540	18,778		13,175	16,255	1,206
2/19/2011	FALSE	FALSE	TRUE	4.71	11.53	9.59	49%	41%	83%		1.20	7.2	7.9									13,175	16,255	1,206				13,175	16,255	1,206
2/20/2011	FALSE	FALSE	FALSE	4.43	9.76	8.46	52%	45%	87%	AvgMax	1.15	7.3	8.2									13,286	16,255	1,246				13,286	16,255	1,246
2/21/2011	FALSE	FALSE	FALSE	5.34	12.56	8.55	62%	43%	68%		1.47	7.3	8.5									13,353	16,409	1,246				13,353	16,409	1,246
2/22/2011	FALSE	FALSE	FALSE	4.65	10.23	8.05	58%	45%	79%		1.27	7.4	8.7	181.00	224.00	1.24		12,152	15,039			13,278	16,257	1,246	12,152	15,039		13,278	16,257	1,246
2/23/2011	FALSE	FALSE	FALSE	4.47	10.24	7.82	57%	44%	76%		1.31	7.4	8.7									13,278	16,257	1,246				13,278	16,257	1,246
2/24/2011	FALSE	FALSE	TRUE	4.47	9.86	7.76	58%	45%	79%		1.27	7.4	8.6	190.00			17.07	12,296		1,105		13,284	16,257	1,217	12,296		1,105	13,284	16,257	1,217
2/25/2011	FALSE	FALSE	TRUE	3.95	13.42	9.38	42%	29%	70%	MinAvg	1.43	7.5	8.4	114.00	154.00	1.35		8,918	12,047			13,165	16,114	1,217	8,918	12,047		13,165	16,114	1,217
2/26/2011	FALSE	FALSE	FALSE	4.19	12.26	8.45	50%	34%	69%		1.45	7.5	8.4									13,165	16,114	1,217				13,165	16,114	1,217
2/27/2011	FALSE	FALSE	FALSE	5.36	11.36	8.09	66%	47%	71%		1.40	7.6	8.1									13,165	16,114	1,172				13,165	16,114	1,172
2/28/2011	FALSE	FALSE	FALSE	3.82	8.49	7.88	48%	45%	93%	AvgMax	1.08	7.6	8.1	171.00				11,238				13,003	16,072	1,172	11,238			13,003	16,072	1,172
3/1/2011	FALSE	FALSE	TRUE	3.56	11.26	7.83	45%	32%	70%		1.44	7.7	8.0	174.00	249.00	1.43		11,363	16,260			12,907	16,093	1,172	11,363	16,260		12,907	16,093	1,172
3/2/2011	FALSE	FALSE	TRUE	3.80	12.05	8.70	44%	32%	72%		1.39	7.7	8.1									12,907	16,093	1,172				12,907	16,093	1,172
3/3/2011	FALSE	FALSE	FALSE	4.16	11.49	8.44	49%	36%	73%		1.36	7.8	8.2	210.00				14,782				13,162	16,093	1,172	14,782			13,162	16,093	1,172
3/4/2011	FALSE	FALSE	FALSE	4.12	10.84	8.17	50%	38%	75%		1.33	7.9	8.3	180.00	259.00	1.44	22.79	12,265	17,648	1,553		13,194	16,191	1,248	12,265	17,648	1,553	13,194	16,191	1,248
3/5/2011	FALSE	FALSE	TRUE	4.04	11.57	7.85	51%	35%	68%		1.47	7.9	8.2									13,194	16,191	1,248				13,194	16,191	1,248
3/6/2011	FALSE	FALSE	TRUE	4.30	12.83	8.87	48%	34%	69%		1.45	8.0	8.3									13,072	16,191	1,304				13,072	16,191	1,304
3/7/2011	FALSE	FALSE	FALSE	4.74	12.40	8.87	53%	38%	72%		1.40	8.0	8.4	114.00				8,433				12,554	15,794	1,304	8,433			12,554	15,794	1,304
3/8/2011	FALSE	FALSE	FALSE	4.25	11.65	8.21	52%	36%	70%		1.42	8.1	8.4	177.00	254.00	1.44		12,119	17,392			12,529	15,972	1,304	12,119	17,392		12,529	15,972	1,304
3/9/2011	FALSE	FALSE	FALSE	3.99	11.46	7.92	50%	35%	69%		1.45	8.1	8.4									12,529	15,972	1,304				12,529	15,972	1,304
3/10/2011	FALSE	FALSE	TRUE	3.87	11.68	8.00	48%	33%	68%		1.46	8.1	8.3	233.00			16.69	15,546		1,114		12,705	15,972	1,266	15,546		1,114	12,705		

Date	Butte Break?	CSU Break?	Precip?	Min Influent Flow, mgd	Max Influent Flow, mgd	Avg Influent Flow, mgd	Min % of Avg	Min % of Max	Avg % of Max	Flow Outlier Type	Diurnal Peak Factor (DPF)	30-d Avg of Avg Flow, mgd	7-d Avg of Avg Flow, mgd	Influent TSS Conc., mg/L	Influent BOD Conc., mg/L	BOD/TSS Ratio	Influent NH3-N Conc., mg/L	Avg Inf TSS Load, ppd	Avg Inf BOD Load, ppd	Avg Inf NH3 Load, ppd	Load Outlier Type	30-d Avg of TSS Load, ppd	30-d Avg of BOD Load, ppd	30-d Avg of NH3-N Load, ppd	non-SN TSS Load, ppd	non-SN BOD Load, ppd	non-SN NH3 Load, ppd	30-d Avg of non-SN TSS Load, ppd	30-d Avg of non-SN BOD Load, ppd	30-d Avg of non-SN NH3-N Load, ppd
3/25/2011	FALSE	FALSE	TRUE	6.71	13.16	10.36	65%	51%	79%		1.27	8.2	9.8	152.00	177.00	1.16		13,133	15,293			12,508	16,228	1,142	13,133	15,293		12,508	16,228	1,142
3/26/2011	FALSE	FALSE	TRUE	6.70	15.37	11.51	58%	44%	75%		1.34	8.4	10.6									12,508	16,228	1,142				12,508	16,228	1,142
3/27/2011	FALSE	FALSE	TRUE	5.57	14.27	10.27	54%	39%	72%		1.39	8.5	10.7									12,519	16,228	1,151				12,519	16,228	1,151
3/28/2011	FALSE	FALSE	FALSE	5.61	14.10	9.67	58%	40%	69%		1.46	8.6	10.5	161.00				12,984				12,745	16,825	1,151	12,984			12,745	16,825	1,151
3/29/2011	FALSE	FALSE	FALSE	4.98	12.31	9.13	55%	40%	74%		1.35	8.6	10.2	167.00				12,716				12,744	16,825	1,151	12,716			12,744	16,825	1,151
3/30/2011	FALSE	FALSE	FALSE	4.74	12.13	8.98	53%	39%	74%		1.35	8.6	10.0									12,744	16,825	1,151				12,744	16,825	1,151
3/31/2011	FALSE	FALSE	FALSE	4.60	11.40	8.78	52%	40%	77%		1.30	8.6	9.8	182.00			12.85	13,327		941		12,854	16,825	1,109	13,327		941	12,854	16,825	1,109
4/1/2011	FALSE	FALSE	FALSE	4.66	8.91	8.43	55%	52%	95%	AvgMax	1.06	8.7	9.8	186.00	229.00	1.23		13,077	16,100			12,944	16,803	1,109	13,077	16,100		12,944	16,803	1,109
4/2/2011	FALSE	FALSE	FALSE	4.34	9.40	8.07	54%	46%	86%	AvgMax	1.16	8.7	9.7									12,944	16,803	1,109				12,944	16,803	1,109
4/3/2011	FALSE	FALSE	FALSE	4.17	9.52	7.93	53%	44%	83%		1.20	8.6	9.1									12,842	16,803	1,109				12,842	16,803	1,109
4/4/2011	FALSE	FALSE	FALSE	4.10	10.32	7.86	52%	40%	76%		1.31	8.6	8.7	174.00				11,406				12,794	16,662	998	11,406			12,794	16,662	998
4/5/2011	FALSE	FALSE	FALSE	4.47	9.99	7.72	58%	45%	77%		1.29	8.6	8.4	168.00	190.00	1.13	14.63	10,817	12,233	942		12,690	16,029	987	10,817	12,233	942	12,690	16,029	987
4/6/2011	FALSE	FALSE	FALSE	4.44	9.93	7.69	58%	45%	77%		1.29	8.6	8.2									12,690	16,029	987				12,690	16,029	987
4/7/2011	FALSE	FALSE	FALSE	4.33	9.83	7.62	57%	44%	78%		1.29	8.5	7.9									12,927	16,029	987				12,927	16,029	987
4/8/2011	FALSE	FALSE	FALSE	3.21	10.53	7.48	43%	30%	71%		1.41	8.5	7.7	189.00	198.00	1.05		11,790	12,352			12,908	15,309	987	11,790	12,352		12,908	15,309	987
4/9/2011	FALSE	FALSE	FALSE	3.59	11.04	7.26	49%	33%	66%		1.52	8.5	7.7									12,908	15,309	987				12,908	15,309	987
4/10/2011	FALSE	FALSE	FALSE	4.00	9.50	7.19	56%	42%	76%		1.32	8.4	7.6									12,753	15,309	955				12,753	15,309	955
4/11/2011	FALSE	FALSE	FALSE	4.10	9.26	7.26	56%	44%	78%		1.28	8.4	7.5	154.00				9,324				12,542	14,778	955	9,324			12,542	14,778	955
4/12/2011	FALSE	FALSE	FALSE	4.20	9.26	7.26	58%	45%	78%		1.28	8.4	7.4	206.00	210.00	1.02		12,473	12,715			12,538	14,484	955	12,473	12,715		12,538	14,484	955
4/13/2011	FALSE	FALSE	TRUE	4.30	9.12	7.20	60%	47%	79%		1.27	8.4	7.4									12,538	14,484	955				12,538	14,484	955
4/14/2011	FALSE	FALSE	FALSE	4.45	8.75	7.16	62%	51%	82%		1.22	8.4	7.3				20.61			1,231		12,703	14,484	1,011		1,231		12,703	14,484	1,011
4/15/2011	FALSE	FALSE	FALSE	3.80	9.40	7.00	54%	40%	74%		1.34	8.3	7.2	220.00	204.00	0.93		12,844	11,910			12,568	14,162	1,011	12,844	11,910		12,568	14,162	1,011
4/16/2011	FALSE	FALSE	FALSE	3.80	9.60	6.76	56%	40%	70%		1.42	8.3	7.1									12,408	14,162	1,011				12,408	14,162	1,011
4/17/2011	FALSE	FALSE	TRUE	3.88	8.93	6.92	56%	43%	77%		1.29	8.2	7.1									12,325	14,162	1,039				12,325	14,162	1,039
4/18/2011	FALSE	FALSE	TRUE	3.88	9.57	7.19	54%	41%	75%		1.33	8.2	7.1	226.00				13,552				12,229	13,697	1,039	13,552			12,229	13,697	1,039
4/19/2011	FALSE	FALSE	FALSE	3.79	9.07	6.99	54%	42%	77%		1.30	8.0	7.1	213.00	219.00	1.03		12,417	12,767			12,240	13,581	1,039	12,417	12,767		12,240	13,581	1,039
4/20/2011	FALSE	FALSE	FALSE	3.90	9.10	7.04	55%	43%	77%		1.29	8.0	7.0									12,240	13,581	1,039				12,240	13,581	1,039
4/21/2011	FALSE	FALSE	TRUE	3.90	9.20	6.92	56%	42%	75%		1.33	8.0	7.0				22.32			1,288		12,120	13,581	1,089		1,288		12,120	13,581	1,089
4/22/2011	FALSE	FALSE	FALSE	4.15	8.66	6.91	60%	48%	80%		1.25	7.9	7.0	238.00	259.00	1.09		13,716	14,926			12,195	13,537	1,089	13,716	14,926		12,195	13,537	1,089
4/23/2011	FALSE	FALSE	FALSE	3.99	9.29	6.61	60%	43%	71%		1.41	7.9	6.9									12,195	13,537	1,089				12,195	13,537	1,089
4/24/2011	FALSE	FALSE	FALSE		8.80	6.02			68%	inAvgMinM	1.46	7.9	6.9									12,398	13,537	1,100				12,398	13,537	1,100
4/25/2011	FALSE	FALSE	FALSE	3.80	8.80	7.15	53%	43%	81%		1.23	7.8	7.0	245.00				14,610				12,504	13,286	1,100	14,610			12,504	13,286	1,100
4/26/2011	FALSE	FALSE	FALSE	3.80	9.00	6.81	56%	42%	76%		1.32	7.6	6.9	270.00	233.00	0.86		15,335	13,233			12,693	13,280	1,100	15,335	13,233		12,693	13,280	1,100
4/27/2011	FALSE	FALSE	FALSE	3.90	9.50	6.77	58%	41%	71%		1.40	7.5	6.9									12,693	13,280	1,100				12,693	13,280	1,100
4/28/2011	FALSE	FALSE	FALSE	3.90	9.50	6.72	58%	41%	71%		1.41	7.4	6.8	313.00			33.84	17,542		1,897		12,996	13,280	1,260	17,542		1,897	12,996	13,280	1,260
4/29/2011	FALSE	FALSE	FALSE	3.67	13.92	6.79	54%	26%	49%	AvgMax	2.05	7.3	6.8	300.00	313.00	1.04		16,989	17,725			13,281	13,773	1,260	16,989	17,725		13,281	13,773	1,260
4/30/2011	FALSE	FALSE	FALSE	3.40	9.99	6.52	52%	34%	65%		1.53	7.2	6.8									13,281	13,773	1,260				13,281	13,773	1,260
5/1/2011	FALSE	FALSE	FALSE	3.66	11.41	6.50	56%	32%	57%	AvgMax	1.76	7.2	6.8									13,278	13,773	1,339				13,278	13,773	1,339
5/2/2011	FALSE	FALSE	FALSE	3.52	9.98	6.70	53%	35%	67%		1.49	7.1	6.8	225.00				12,573				13,242	13,483	1,339	12,573			13,242	13,483	1,339
5/3/2011	FALSE	FALSE	FALSE	3.52	10.06	6.61	53%	35%	66%		1.52	7.1	6.7	226.00	225.00	1.00		12,459	12,404			13,190	13,363	1,339	12,459	12,404		13,190	13,363	1,339
5/4/2011	FALSE	FALSE	FALSE	3.53	9.85	6.66	53%	36%	68%		1.48	7.1	6.7									13,190	13,363	1,339				13,190	13,363	1,339
5/5/2011	FALSE	FALSE	FALSE	3.57	9.97	6.59	54%	36%	66%		1.51	7.0	6.6	237.00			22.45	13,026		1,234		13,298	13,363	1,318	13,026		1,234	13,298	13,363	1,318
5/6/2011	FALSE	FALSE	FALSE	3.90	9.60	6.61	59%	41%	69%		1.45	7.0	6.6	231.00	221.00	0.96		12,734	12,183			13,426	13,357	1,412	12,734	12,183		13,426	13,357	1,412
5/7/2011	FALSE	FALSE	TRUE	3.80	8.80	6.45	59%	43%	73%		1.36	6.9	6.6									13,426	13,357	1,412				13,426	13,357	1,412
5/8/2011	FALSE	FALSE	TRUE	3.41	10.37	6.49	53%	33%	63%		1.60	6.9	6.6									13,426	13,357	1,412				13,426	13,357	1,412
5/9/2011	FALSE	FALSE	TRUE	3.41	10.72	6.91	49%	32%	64%		1.55	6.9	6.6	275.00				15,848				13,696	13,483	1,412	15,848			13,696	13,483	1,412
5/10/2011	FALSE	FALSE	FALSE	3.45	11.01	6.72	51%	31%	61%		1.64	6.9	6.6	257.00	266.00	1.04		14,404	14,908			13,740	13,641	1,412	14,404	14,908		13,740	13,641	1,412
5/11/2011	FALSE	FALSE	FALSE	3.57	9.72	6.71	53%	37%	69%		1.45	6.8	6.6				26.64			1,491		13,740	13,641	1,428		1,491		13,740	13,641	1,428
5/12/2011	FALSE	FALSE	FALSE	3.61	9.82	6.68	54%	37%	68%		1.47	6.8	6.6	270.00				15,042				14,098	13,641	1,428	15,042			14,098	13,641	1,428
5/13/2011	FALSE	FALSE	FALSE	3.66	10.55	6.61	55%	35%	63%	</																				

Date	Butte Break?	CSU Break?	Precip?	Min Influent Flow, mgd	Max Influent Flow, mgd	Avg Influent Flow, mgd	Min % of Avg	Min % of Max	Avg % of Max	Flow Outlier Type	Diurnal Peak Factor (DPF)	30-d Avg of Avg Flow, mgd	7-d Avg of Avg Flow, mgd	Influent TSS Conc., mg/L	Influent BOD Conc., mg/L	BOD/TSS Ratio	Influent NH3-N Conc., mg/L	Avg Inf TSS Load, ppd	Avg Inf BOD Load, ppd	Avg Inf NH3 Load, ppd	Load Outlier Type	30-d Avg of TSS Load, ppd	30-d Avg of BOD Load, ppd	30-d Avg of NH3-N Load, ppd	non-SN TSS Load, ppd	non-SN BOD Load, ppd	non-SN NH3 Load, ppd	30-d Avg of non-SN TSS Load, ppd	30-d Avg of non-SN BOD Load, ppd	30-d Avg of non-SN NH3-N Load, ppd
5/27/2011	TRUE	TRUE	FALSE	4.12	8.84	7.03	59%	47%	80%		1.26	6.9	7.1	195.00				11,433				13,965	13,940	1,359	10,564			13,917	13,940	1,359
5/28/2011	TRUE	TRUE	TRUE	3.97	9.17	6.77	59%	43%	74%		1.35	6.9	7.1									13,965	13,940	1,359			13,917	13,940	1,359	
5/29/2011	TRUE	TRUE	FALSE	3.91	8.89	6.44	61%	44%	72%		1.38	6.8	7.0									13,755	13,940	1,225			13,704	13,940	1,225	
5/30/2011	TRUE	TRUE	FALSE	3.73	9.54	6.56	57%	39%	69%		1.45	6.8	7.0									13,553	13,400	1,225			13,498	13,400	1,225	
5/31/2011	TRUE	TRUE	TRUE	3.61	8.59	6.69	54%	42%	78%		1.28	6.8	7.0	222.00				12,386				13,484	13,400	1,225	12,386		13,433	13,400	1,225	
6/1/2011	TRUE	TRUE	TRUE	3.71	8.45	6.65	56%	44%	79%		1.27	6.8	6.9	197.00	190.00	0.96		10,926	10,538			13,342	13,042	1,225	10,926	10,538	13,294	13,042	1,225	
6/2/2011	TRUE	TRUE	FALSE	3.70	8.40	6.47	57%	44%	77%		1.30	6.8	6.7	249.00				13,436				13,390	13,042	1,225	13,436		13,342	13,042	1,225	
6/3/2011	TRUE	TRUE	FALSE	3.88	7.39	6.34	61%	53%	86%	AvgMax	1.17	6.8	6.7	280.00			18.21	14,805		963		13,520	13,133	1,172	14,805		963	13,472	13,133	1,172
6/4/2011	TRUE	TRUE	TRUE	3.63	8.50	6.37	57%	43%	75%		1.33	6.8	6.6									13,520	13,133	1,172			13,472	13,133	1,172	
6/5/2011	TRUE	TRUE	TRUE	3.70	8.60	6.36	58%	43%	74%		1.35	6.8	6.5									13,549	13,133	1,157			13,498	13,133	1,157	
6/6/2011	TRUE	TRUE	FALSE	3.80	8.40	6.61	57%	45%	79%		1.27	6.8	6.5	189.00				10,419				13,413	13,292	1,157	10,419		13,362	13,292	1,157	
6/7/2011	TRUE	TRUE	TRUE	3.70	8.50	6.59	56%	44%	78%		1.29	6.8	6.5	282.00	203.00	0.72		15,499	11,157			13,529	12,987	1,157	15,499	11,157	13,481	12,987	1,157	
6/8/2011	TRUE	TRUE	FALSE	4.00	8.10	6.51	61%	49%	80%		1.24	6.8	6.5	249.00				13,519				13,528	12,987	1,157	13,519		13,483	12,987	1,157	
6/9/2011	TRUE	TRUE	FALSE	3.90	8.00	6.38	61%	49%	80%		1.25	6.8	6.5	245.00			19.10	13,036		1,016		13,380	12,987	1,129	13,036		1,016	13,335	12,987	1,129
6/10/2011	TRUE	TRUE	FALSE	3.86	8.21	6.26	62%	47%	76%		1.31	6.8	6.4	204.00	243.00	1.19		10,651	12,687			13,183	12,669	1,129	10,651	12,687	13,137	12,669	1,129	
6/11/2011	TRUE	TRUE	FALSE	3.76	8.34	6.08	62%	45%	73%		1.37	6.8	6.4					13,183				13,183	12,669	1,038			13,137	12,669	1,038	
6/12/2011	TRUE	TRUE	FALSE	3.75	8.42	6.09	62%	45%	72%		1.38	6.7	6.4									13,080	12,669	1,038			13,031	12,669	1,038	
6/13/2011	TRUE	TRUE	FALSE	3.75	8.05	6.34	59%	47%	79%		1.27	6.7	6.4	235.00				12,426				12,738	11,979	1,038	12,426		12,690	11,979	1,038	
6/14/2011	TRUE	TRUE	FALSE	3.92	7.90	6.28	62%	50%	79%		1.26	6.7	6.3	234.00	218.00	0.93		12,256	11,418			12,712	11,899	1,038	12,256	11,418	12,667	11,899	1,038	
6/15/2011	TRUE	TRUE	FALSE	3.74	8.25	6.22	60%	45%	75%		1.33	6.7	6.3									12,712	11,899	1,038			12,667	11,899	1,038	
6/16/2011	TRUE	TRUE	FALSE	3.76	7.86	6.22	60%	48%	79%		1.26	6.7	6.2	272.00			21.93	14,110		1,138		12,697	11,899	1,058	14,110		1,138	12,651	11,899	1,058
6/17/2011	TRUE	TRUE	FALSE	3.90	7.86	6.15	63%	50%	78%		1.28	6.6	6.2	239.00	218.00	0.91		12,259	11,181			12,591	11,595	1,058	12,259	11,181	12,545	11,595	1,058	
6/18/2011	TRUE	TRUE	FALSE	3.83	7.68	5.88	65%	50%	77%		1.31	6.6	6.2									12,591	11,595	1,047			12,545	11,595	1,047	
6/19/2011	TRUE	TRUE	FALSE	3.62	7.88	5.89	61%	46%	75%		1.34	6.5	6.1									12,558	11,595	1,047			12,510	11,595	1,047	
6/20/2011	TRUE	TRUE	FALSE	3.79	7.99	6.20	61%	47%	78%		1.29	6.5	6.1	291.00			21.83	15,047		1,129		12,691	11,216	1,063	15,047		1,129	12,643	11,216	1,063
6/21/2011	TRUE	TRUE	FALSE	3.57	7.64	6.00	60%	47%	79%		1.27	6.5	6.1	242.00	230.00	0.95		12,110	11,509			12,660	11,258	1,063	12,110	11,509	12,614	11,258	1,063	
6/22/2011	TRUE	TRUE	FALSE	3.56	7.71	6.01	59%	46%	78%		1.28	6.5	6.1									12,660	11,258	1,063			12,614	11,258	1,063	
6/23/2011	TRUE	TRUE	FALSE	3.62	7.34	5.99	60%	49%	82%		1.23	6.4	6.0	252.00				12,589				12,781	11,258	1,061	12,589		12,736	11,258	1,061	
6/24/2011	TRUE	TRUE	FALSE	3.46	7.83	5.90	59%	44%	75%		1.33	6.4	6.0	244.00				12,006				12,625	11,258	1,061	11,066		12,530	11,258	1,061	
6/25/2011	TRUE	TRUE	FALSE	3.51	7.85	5.71	61%	45%	73%		1.37	6.3	5.9									12,625	11,258	1,061			12,530	11,258	1,061	
6/26/2011	TRUE	TRUE	FALSE	3.54	7.33	5.68	62%	48%	77%		1.29	6.3	5.9									12,717	11,415	1,061			12,617	11,415	1,061	
6/27/2011	TRUE	TRUE	FALSE	3.55	7.40	6.01	59%	48%	81%		1.23	6.2	5.9	238.00				11,929				12,745	11,415	1,061	11,929		12,693	11,415	1,061	
6/28/2011	TRUE	TRUE	TRUE	3.50	9.36	6.94	50%	37%	74%		1.35	6.2	6.0	308.00	216.00	0.70		17,827	12,502			13,012	11,570	1,061	17,827	12,502	12,963	11,570	1,061	
6/29/2011	TRUE	TRUE	FALSE	3.97	7.56	6.79	58%	53%	90%	AvgMax	1.11	6.2	6.0									13,012	11,570	1,061			12,963	11,570	1,061	
6/30/2011	TRUE	TRUE	FALSE	3.96	7.53	6.39	62%	53%	85%		1.18	6.2	6.1	268.00	224.00	0.84		14,282	11,938			13,076	11,616	1,061	14,282	11,938	13,029	11,616	1,061	
7/1/2011	TRUE	TRUE	FALSE	3.67	7.90	6.07	60%	46%	77%		1.30	6.2	6.1	217.00			18.68	10,985		946		13,006	11,616	1,038	10,985		946	12,959	11,616	1,038
7/2/2011	TRUE	TRUE	FALSE	3.55	7.83	5.73	62%	45%	73%		1.37	6.2	6.1									13,115	11,770	1,038			13,066	11,770	1,038	
7/3/2011	TRUE	TRUE	FALSE	3.53	7.54	5.50	64%	47%	73%		1.37	6.2	6.0									13,098	11,770	1,038			13,045	11,770	1,038	
7/4/2011	TRUE	TRUE	FALSE	3.70	6.40	5.52	67%	58%	86%	inMaxAvgM	1.16	6.2	6.1									12,997	11,770	1,057			12,942	11,770	1,057	
7/5/2011	TRUE	TRUE	FALSE	3.51	7.64	6.06	58%	46%	79%		1.26	6.1	6.1	243.00	163.00	0.67		12,281	8,238			12,957	11,329	1,057	12,281	8,238	12,905	11,329	1,057	
7/6/2011	TRUE	TRUE	FALSE	3.70	7.40	6.15	60%	50%	83%		1.20	6.1	6.0									12,957	11,329	1,057			12,905	11,329	1,057	
7/7/2011	TRUE	TRUE	FALSE	3.63	7.89	6.05	60%	46%	77%		1.30	6.1	6.0	250.00			17.36	12,614		876		13,079	11,329	1,021	12,614		876	13,027	11,329	1,021
7/8/2011	TRUE	TRUE	FALSE	3.70	7.60	5.92	63%	49%	78%		1.28	6.1	5.9	214.00	191.00	0.89		10,566	9,430			12,805	11,113	1,021	10,566	9,430	12,753	11,113	1,021	
7/9/2011	TRUE	TRUE	FALSE	3.60	7.60	5.76	63%	47%	76%		1.32	6.1	5.9									12,763	11,113	1,021			12,708	11,113	1,021	
7/10/2011	TRUE	TRUE	FALSE	3.45	7.91	5.83	59%	44%	74%		1.36	6.0	5.9									12,746	11,113	1,022			12,687	11,113	1,022	
7/11/2011	TRUE	TRUE	FALSE	3.47	8.73	6.12	57%	40%	70%		1.43	6.0	6.0									12,886	10,888	1,022			12,823	10,888	1,022	
7/12/2011	TRUE	TRUE	FALSE	3.35	8.77	6.14	55%	38%	70%		1.43	6.0	6.0	311.00	208.00	0.67		15,926	10,651			13,076	10,858	1,022	15,926	10,651	13,017	10,858	1,022	
7/13/2011	TRUE	TRUE	FALSE	3.32	8.92	6.11	54%	37%	68%		1.46	6.0	6.0									13,076	10,858	1,022			13,017	10,858	1,022	
7/14/2011	TRUE	TRUE	FALSE	3.38	8.91	6.07	56%	38%	68%		1.47	6.0	6.0	245.00			20.15	12,403		1,020		13,074	10,858	1,022	12,403		1,020	13,016	10,858	1,022
7/15/2011	TRUE	TRUE	FALSE	3.83	7.48	5.97	64%	51%	80%		1.25	6.0	6.0	238.00	150.00	0.63		11,850	7,468			13,049	10,365	1,022	11,850	7,468	12,990</			

Date	Butte Break?	CSU Break?	Precip?	Min Influent Flow, mgd	Max Influent Flow, mgd	Avg Influent Flow, mgd	Min % of Avg	Min % of Max	Avg % of Max	Flow Outlier Type	Diurnal Peak Factor (DPF)	30-d Avg of Avg Flow, mgd	7-d Avg of Avg Flow, mgd	Influent TSS Conc., mg/L	Influent BOD Conc., mg/L	BOD/TSS Ratio	Influent NH3-N Conc., mg/L	Avg Inf TSS Load, ppd	Avg Inf BOD Load, ppd	Avg Inf NH3 Load, ppd	Load Outlier Type	30-d Avg of TSS Load, ppd	30-d Avg of BOD Load, ppd	30-d Avg of NH3-N Load, ppd	non-SN TSS Load, ppd	non-SN BOD Load, ppd	non-SN NH3 Load, ppd	30-d Avg of non-SN TSS Load, ppd	30-d Avg of non-SN BOD Load, ppd	30-d Avg of non-SN NH3-N Load, ppd
7/29/2011	TRUE	TRUE	FALSE	3.60	7.70	5.95	61%	47%	77%		1.29	6.0	5.9	272.00	204.00	0.75		13,497	10,123			12,511	9,712	954	13,497	10,123		12,511	9,712	954
7/30/2011	TRUE	TRUE	FALSE	3.70	7.70	5.76	64%	48%	75%		1.34	5.9	5.9									12,511	9,712	954				12,511	9,712	954
7/31/2011	TRUE	TRUE	FALSE	3.29	8.86	5.77	57%	37%	65%		1.54	5.9	5.9									12,393	9,433	954				12,393	9,433	954
8/1/2011	TRUE	TRUE	FALSE	3.36	9.04	6.02	56%	37%	67%		1.50	5.9	5.9									12,493	9,433	956				12,493	9,433	956
8/2/2011	TRUE	TRUE	FALSE	3.33	8.70	6.04	55%	38%	69%		1.44	5.9	5.9	244.00	189.00	0.77		12,291	9,521			12,480	9,443	956	12,291	9,521		12,480	9,443	956
8/3/2011	TRUE	TRUE	FALSE	3.37	8.61	6.01	56%	39%	70%		1.43	6.0	5.9									12,480	9,443	956				12,480	9,443	956
8/4/2011	TRUE	TRUE	FALSE	3.38	8.86	6.07	56%	38%	69%		1.46	6.0	6.0	202.00			20.17	10,226		1,021		12,339	9,443	969	10,226		1,021	12,339	9,443	969
8/5/2011	TRUE	TRUE	FALSE	3.61	7.58	5.98	60%	48%	79%		1.27	6.0	6.0	298.00				14,862				12,500	9,594	969	14,862			12,500	9,594	969
8/6/2011	TRUE	TRUE	FALSE	3.70	7.83	5.86	63%	47%	75%		1.34	5.9	5.9									12,500	9,594	969				12,500	9,594	969
8/7/2011	TRUE	TRUE	FALSE	3.70	7.60	5.81	64%	49%	76%		1.31	5.9	5.9									12,492	9,594	992				12,492	9,594	992
8/8/2011	TRUE	TRUE	FALSE	3.60	7.50	6.09	59%	48%	81%		1.23	5.9	6.0									12,630	9,617	992				12,630	9,617	992
8/9/2011	TRUE	TRUE	FALSE	3.60	8.90	6.23	58%	40%	70%		1.43	6.0	6.0	232.00				12,054				12,592	9,617	992	12,054			12,592	9,617	992
8/10/2011	TRUE	TRUE	FALSE	3.60	7.80	6.10	59%	46%	78%		1.28	6.0	6.0	300.00				15,262				12,759	9,617	992	15,262			12,759	9,617	992
8/11/2011	TRUE	TRUE	FALSE	3.40	7.70	6.11	56%	44%	79%		1.26	6.0	6.0	221.00			19.09	11,262		973		12,671	9,617	988	11,262		973	12,671	9,617	988
8/12/2011	TRUE	TRUE	FALSE	3.35	8.96	6.03	56%	37%	67%		1.49	6.0	6.0	303.00	206.00	0.68		15,238	10,360			12,630	9,575	988	15,238	10,360		12,630	9,575	988
8/13/2011	TRUE	TRUE	FALSE	3.39	9.30	5.95	57%	36%	64%		1.56	6.0	6.0									12,630	9,575	988				12,630	9,575	988
8/14/2011	TRUE	TRUE	FALSE	3.70	9.20	6.12	60%	40%	67%		1.50	6.0	6.1									12,644	9,575	981				12,644	9,575	981
8/15/2011	TRUE	TRUE	FALSE	3.30	9.20	6.29	52%	36%	68%		1.46	6.0	6.1									12,697	9,926	981				12,697	9,926	981
8/16/2011	TRUE	TRUE	FALSE	3.40	9.22	6.49	52%	37%	70%		1.42	6.0	6.2	309.00				16,725				12,949	9,926	981	16,725			12,949	9,926	981
8/17/2011	TRUE	TRUE	FALSE	5.30	7.95	6.53	81%	67%	82%	inAvgMinM	1.22	6.0	6.2	199.00				10,838				12,825	9,926	981	10,838			12,825	9,926	981
8/18/2011	TRUE	TRUE	FALSE	4.01	7.88	6.64	60%	51%	84%		1.19	6.0	6.2	200.00			18.79	11,076		1,041		12,745	9,926	993	11,076		1,041	12,745	9,926	993
8/19/2011	TRUE	TRUE	FALSE	3.80	8.40	6.68	57%	45%	80%		1.26	6.0	6.3	184.00	170.00	0.92		10,251	9,471			12,530	9,635	993	10,251	9,471		12,530	9,635	993
8/20/2011	TRUE	TRUE	FALSE	3.70	8.60	6.51	57%	43%	76%		1.32	6.1	6.4									12,530	9,635	993				12,530	9,635	993
8/21/2011	TRUE	TRUE	FALSE	3.38	10.58	6.68	51%	32%	63%		1.58	6.1	6.5									12,590	9,635	985				12,590	9,635	985
8/22/2011	TRUE	TRUE	FALSE	3.40	10.50	6.78	50%	32%	65%		1.55	6.1	6.6	210.00				11,874				12,547	9,346	985	11,874			12,547	9,346	985
8/23/2011	FALSE	FALSE	FALSE	3.42	10.35	6.68	51%	33%	65%		1.55	6.1	6.6	247.00	180.00	0.73		13,761	10,028			12,618	9,460	985	13,761	10,028		12,618	9,460	985
8/24/2011	FALSE	FALSE	FALSE	3.36	10.55	6.74	50%	32%	64%		1.57	6.2	6.7									12,618	9,460	985				12,618	9,460	985
8/25/2011	FALSE	FALSE	FALSE	3.46	10.31	6.72	51%	34%	65%		1.53	6.2	6.7	262.00			18.16	14,684		1,018		12,861	9,460	992	14,684		1,018	12,861	9,460	992
8/26/2011	FALSE	FALSE	FALSE	3.94	9.03	6.76	58%	44%	75%		1.34	6.2	6.7	232.00	203.00	0.88		13,080	11,445			12,891	10,158	992	13,080	11,445		12,891	10,158	992
8/27/2011	FALSE	FALSE	FALSE	4.00	8.57	6.58	61%	47%	77%		1.30	6.2	6.7									12,936	10,158	992				12,936	10,158	992
8/28/2011	FALSE	FALSE	FALSE	3.80	8.60	6.60	58%	44%	77%		1.30	6.3	6.7									12,936	10,158	1,013				12,936	10,158	1,013
8/29/2011	FALSE	FALSE	FALSE	3.80	8.50	6.69	57%	45%	79%		1.27	6.3	6.7	236.00				13,168				12,916	10,165	1,013	13,168			12,916	10,165	1,013
8/30/2011	FALSE	FALSE	FALSE	3.70	8.90	6.72	55%	42%	76%		1.32	6.3	6.7	241.00	169.00	0.70		13,507	9,472			12,950	10,049	1,013	13,507	9,472		12,950	10,049	1,013
8/31/2011	FALSE	FALSE	FALSE	3.80	8.90	6.74	56%	43%	76%		1.32	6.4	6.7									12,950	10,049	1,013				12,950	10,049	1,013
9/1/2011	FALSE	FALSE	FALSE	3.80	8.90	6.76	56%	43%	76%		1.32	6.4	6.7	213.00			20.60	12,009		1,161		12,898	10,049	1,043	12,009		1,161	12,898	10,049	1,043
9/2/2011	FALSE	FALSE	FALSE	3.40	9.60	6.65	51%	35%	69%		1.44	6.4	6.7	234.00	193.00	0.82		12,978	10,704			12,936	10,247	1,043	12,978	10,704		12,936	10,247	1,043
9/3/2011	FALSE	FALSE	FALSE	3.40	9.85	6.40	53%	35%	65%		1.54	6.4	6.6									12,936	10,247	1,043				12,936	10,247	1,043
9/4/2011	FALSE	FALSE	FALSE	3.40	9.43	6.29	54%	36%	67%		1.50	6.4	6.6									13,096	10,247	1,048				13,096	10,247	1,048
9/5/2011	FALSE	FALSE	FALSE	3.62	9.01	6.65	54%	40%	74%		1.35	6.4	6.6									12,985	10,247	1,048				12,985	10,247	1,048
9/6/2011	FALSE	FALSE	FALSE	3.62	9.04	6.72	54%	40%	74%		1.35	6.5	6.6	213.00	179.00	0.84		11,938	10,032			12,924	10,216	1,048	11,938	10,032		12,924	10,216	1,048
9/7/2011	FALSE	FALSE	FALSE	3.66	8.98	6.74	54%	41%	75%		1.33	6.5	6.6	188.00				10,568				12,793	10,216	1,048	10,568			12,793	10,216	1,048
9/8/2011	FALSE	FALSE	FALSE	3.67	8.91	6.72	55%	41%	75%		1.33	6.5	6.6									12,793	10,216	1,048				12,793	10,216	1,048
9/9/2011	FALSE	FALSE	FALSE	3.70	8.90	6.73	55%	42%	76%		1.32	6.5	6.6	219.00			21.03	12,292		1,180		12,806	10,216	1,075	12,292		1,180	12,806	10,216	1,075
9/10/2011	FALSE	FALSE	FALSE	3.73	8.62	6.46	58%	43%	75%		1.33	6.6	6.6									12,661	10,216	1,075				12,661	10,216	1,075
9/11/2011	FALSE	FALSE	FALSE	3.36	10.01	6.61	51%	34%	66%		1.51	6.6	6.6									12,749	10,216	1,100				12,749	10,216	1,100
9/12/2011	FALSE	FALSE	FALSE	3.40	9.68	7.03	48%	35%	73%		1.38	6.6	6.7	204.00				11,961				12,544	10,192	1,100	11,961			12,544	10,192	1,100
9/13/2011	FALSE	FALSE	FALSE	3.70	9.00	6.44	57%	41%	72%		1.40	6.6	6.7	238.00	180.00	0.76		12,783	9,668			12,558	10,117	1,100	12,783	9,668		12,558	10,117	1,100
9/14/2011	FALSE	FALSE	FALSE	3.70	9.30	6.82	54%	40%	73%		1.36	6.6	6.7									12,558	10,117	1,100				12,558	10,117	1,100
9/15/2011	FALSE	FALSE	FALSE	3.36	9.90	6.75	50%	34%	68%		1.47	6.7	6.7				19.75			1,112		12,558	10,117	1,102			1,112	12,558	10,117	1,102
9/16/2011	FALSE	FALSE	FALSE	3.75	8.93	6.79	55%	42%	76%		1.32	6.7	6.7	198.00	181.00	0.91		11,212	10,250			12,234	10,134	1,102	11,212	10,250		12,234	10,134	1,102
9/17/2011	FALSE	FALSE	FALSE	3.71	8.59																									

Date	Butte Break?	CSU Break?	Precip?	Min Influent Flow, mgd	Max Influent Flow, mgd	Avg Influent Flow, mgd	Min % of Avg	Min % of Max	Avg % of Max	Flow Outlier Type	Diurnal Peak Factor (DPF)	30-d Avg of Avg Flow, mgd	7-d Avg of Avg Flow, mgd	Influent TSS Conc., mg/L	Influent BOD Conc., mg/L	BOD/TSS Ratio	Influent NH3-N Conc., mg/L	Avg Inf TSS Load, ppd	Avg Inf BOD Load, ppd	Avg Inf NH3 Load, ppd	Load Outlier Type	30-d Avg of TSS Load, ppd	30-d Avg of BOD Load, ppd	30-d Avg of NH3-N Load, ppd	non-SN TSS Load, ppd	non-SN BOD Load, ppd	non-SN NH3 Load, ppd	30-d Avg of non-SN TSS Load, ppd	30-d Avg of non-SN BOD Load, ppd	30-d Avg of non-SN NH3-N Load, ppd
9/30/2011	FALSE	FALSE	FALSE	3.80	8.40	6.71	57%	45%	80%		1.25	6.7	6.7	183.00	184.00	1.01		10,241	10,297			11,951	10,001	1,166	10,241	10,297		11,951	10,001	1,166
10/1/2011	FALSE	FALSE	FALSE	3.50	8.30	6.48	54%	42%	78%		1.28	6.6	6.6									11,951	10,001	1,166				11,951	10,001	1,166
10/2/2011	FALSE	FALSE	FALSE	3.37	9.98	6.59	51%	34%	66%		1.51	6.6	6.7									11,947	10,001	1,167				11,947	10,001	1,167
10/3/2011	FALSE	FALSE	TRUE	3.35	9.77	6.82	49%	34%	70%		1.43	6.6	6.7	215.00				12,229				11,894	9,884	1,167	12,229			11,894	9,884	1,167
10/4/2011	FALSE	FALSE	TRUE	3.43	10.15	7.20	48%	34%	71%		1.41	6.7	6.8	218.00	177.00	0.81		13,090	10,628			11,974	9,990	1,167	13,090	10,628		11,974	9,990	1,167
10/5/2011	FALSE	FALSE	TRUE	3.69	11.67	7.92	47%	32%	68%		1.47	6.7	6.9									11,974	9,990	1,167				11,974	9,990	1,167
10/6/2011	FALSE	FALSE	TRUE	3.79	11.48	8.11	47%	33%	71%		1.42	6.8	7.1	223.00			12.44	15,083		841		12,168	9,990	1,102	15,083		841	12,168	9,990	1,102
10/7/2011	FALSE	FALSE	FALSE	4.14	10.03	7.42	56%	41%	74%		1.35	6.8	7.2	200.00	168.00	0.84		12,377	10,396			12,195	10,042	1,102	12,377	10,396		12,195	10,042	1,102
10/8/2011	FALSE	FALSE	FALSE	4.04	9.07	6.95	58%	45%	77%		1.31	6.8	7.2									12,304	10,042	1,102				12,304	10,042	1,102
10/9/2011	FALSE	FALSE	FALSE	3.60	9.40	6.96	52%	38%	74%		1.35	6.8	7.2									12,304	10,042	1,102				12,304	10,042	1,102
10/10/2011	FALSE	FALSE	TRUE	3.94	9.74	7.87	50%	40%	81%		1.24	6.8	7.4	189.00	180.00	0.95		12,405	11,814			12,311	10,264	1,082	12,405	11,814		12,311	10,264	1,082
10/11/2011	FALSE	FALSE	TRUE	3.80	9.50	7.65	50%	40%	81%		1.24	6.9	7.5	218.00			19.41	13,909		1,238		12,411	10,264	1,114	13,909		1,238	12,411	10,264	1,114
10/12/2011	FALSE	FALSE	FALSE	3.90	9.90	7.28	54%	39%	74%		1.36	6.9	7.5									12,411	10,264	1,114				12,411	10,264	1,114
10/13/2011	FALSE	FALSE	FALSE	4.58	8.77	7.14	64%	52%	81%		1.23	6.9	7.4	195.00				11,612				12,389	10,264	1,114	11,612			12,389	10,264	1,114
10/14/2011	FALSE	FALSE	FALSE	3.47	10.15	6.92	50%	34%	68%		1.47	6.9	7.3	217.00	207.00	0.95		12,524	11,947			12,373	10,548	1,114	12,524	11,947		12,373	10,548	1,114
10/15/2011	FALSE	FALSE	FALSE	3.43	10.00	6.70	51%	34%	67%		1.49	6.9	7.2									12,373	10,548	1,114				12,373	10,548	1,114
10/16/2011	FALSE	FALSE	FALSE	3.59	9.09	6.72	53%	39%	74%		1.35	6.9	7.2									12,373	10,548	1,114				12,373	10,548	1,114
10/17/2011	FALSE	FALSE	FALSE	3.64	9.22	6.88	53%	39%	75%		1.34	6.9	7.1	191.00				10,959				12,357	10,591	1,114	10,959			12,357	10,591	1,114
10/18/2011	FALSE	FALSE	FALSE	3.70	9.06	6.85	54%	41%	76%		1.32	6.9	7.0	204.00	178.00	0.87		11,654	10,169			12,316	10,538	1,114	11,654	10,169		12,316	10,538	1,114
10/19/2011	FALSE	FALSE	FALSE	3.70	9.04	6.76	55%	41%	75%		1.34	6.9	6.9									12,316	10,538	1,114				12,316	10,538	1,114
10/20/2011	FALSE	FALSE	FALSE	3.72	9.13	6.77	55%	41%	74%		1.35	6.9	6.8				22.16			1,251		12,412	10,538	1,141			1,251	12,412	10,538	1,141
10/21/2011	FALSE	FALSE	FALSE	3.60	8.30	6.74	53%	43%	81%		1.23	6.9	6.8	229.00				12,872				12,512	10,689	1,141	12,872			12,512	10,689	1,141
10/22/2011	FALSE	FALSE	FALSE	3.70	8.90	6.52	57%	42%	73%		1.37	6.9	6.7									12,512	10,689	1,141				12,512	10,689	1,141
10/23/2011	FALSE	FALSE	FALSE	3.33	9.71	6.61	50%	34%	68%		1.47	6.9	6.7									12,417	10,689	1,140				12,417	10,689	1,140
10/24/2011	FALSE	FALSE	FALSE	3.34	10.32	7.02	48%	32%	68%		1.47	7.0	6.8	269.00				15,749				12,625	10,689	1,140	15,749			12,625	10,689	1,140
10/25/2011	FALSE	FALSE	FALSE	3.41	10.03	6.80	50%	34%	68%		1.48	7.0	6.8	234.00	174.00	0.74		13,271	9,868			12,663	10,586	1,140	13,271	9,868		12,663	10,586	1,140
10/26/2011	FALSE	FALSE	FALSE	3.29	10.34	6.76	49%	32%	65%		1.53	7.0	6.7									12,663	10,586	1,140				12,663	10,586	1,140
10/27/2011	FALSE	FALSE	FALSE	3.33	9.82	6.75	49%	34%	69%		1.45	7.0	6.7	505.00			22.20	28,429		1,250	TSS	12,628	10,586	1,162	28,429		1,250	12,628	10,586	1,162
10/28/2011	FALSE	FALSE	FALSE	3.65	8.93	6.79	54%	41%	76%		1.32	7.0	6.7	235.00	224.00	0.95		13,308	12,685			12,763	10,976	1,162	13,308	12,685		12,763	10,976	1,162
10/29/2011	FALSE	FALSE	FALSE	3.67	9.38	6.71	55%	39%	72%		1.40	7.0	6.7									12,763	10,976	1,162				12,763	10,976	1,162
10/30/2011	FALSE	FALSE	FALSE	3.56	8.95	6.60	54%	40%	74%		1.36	7.0	6.8									12,752	10,976	1,145				12,752	10,976	1,145
10/31/2011	FALSE	FALSE	FALSE	3.72	8.41	6.54	57%	44%	78%		1.29	7.0	6.7	209.00				11,400				12,829	11,072	1,145	11,400			12,829	11,072	1,145
11/1/2011	FALSE	FALSE	FALSE	3.54	8.62	6.59	54%	41%	76%		1.31	7.0	6.7	271.00	238.00	0.88		14,894	13,081			12,958	11,324	1,145	14,894	13,081		12,958	11,324	1,145
11/2/2011	FALSE	FALSE	FALSE	3.79	8.84	6.77	56%	43%	77%		1.31	7.0	6.7									12,958	11,324	1,145				12,958	11,324	1,145
11/3/2011	FALSE	FALSE	TRUE	3.69	8.99	6.78	54%	41%	75%		1.33	7.0	6.7				20.52			1,160		13,007	11,324	1,148			1,160	13,007	11,324	1,148
11/4/2011	FALSE	FALSE	FALSE	3.37	9.79	6.68	50%	34%	68%		1.47	7.0	6.7	264.00	212.00	0.80		14,708	11,811			13,115	11,471	1,148	14,708	11,811		13,115	11,471	1,148
11/5/2011	FALSE	FALSE	TRUE	3.39	10.03	6.82	50%	34%	68%		1.47	6.9	6.7									13,115	11,471	1,148				13,115	11,471	1,148
11/6/2011	FALSE	FALSE	TRUE	3.81	9.27	6.82	56%	41%	74%		1.36	6.9	6.7									12,974	11,471	1,225				12,974	11,471	1,225
11/7/2011	FALSE	FALSE	FALSE	3.93	8.92	6.79	58%	44%	76%		1.31	6.9	6.7	308.00				17,442				13,336	11,625	1,225	17,442			13,336	11,625	1,225
11/8/2011	FALSE	FALSE	FALSE	3.29	10.21	6.71	49%	32%	66%		1.52	6.8	6.7	202.00				11,304				13,201	11,625	1,225	11,304			13,201	11,625	1,225
11/9/2011	FALSE	FALSE	FALSE	3.39	10.43	6.70	51%	33%	64%		1.56	6.8	6.8	186.00	180.00	0.97		10,393	10,058			13,025	11,429	1,225	10,393	10,058		13,025	11,429	1,225
11/10/2011	FALSE	FALSE	FALSE	3.32	9.63	6.62	50%	34%	69%		1.45	6.8	6.7	228.00			21.32	12,588		1,177		13,037	11,374	1,215	12,588		1,177	13,037	11,374	1,215
11/11/2011	FALSE	FALSE	FALSE	3.59	9.33	6.74	53%	38%	72%		1.38	6.8	6.7									12,979	11,374	1,210				12,979	11,374	1,210
11/12/2011	FALSE	FALSE	FALSE	3.61	8.94	6.43	56%	40%	72%		1.39	6.7	6.7									12,979	11,374	1,210				12,979	11,374	1,210
11/13/2011	FALSE	FALSE	FALSE	3.37	10.10	6.61	51%	33%	65%		1.53	6.7	6.7									13,076	11,374	1,210				13,076	11,374	1,210
11/14/2011	FALSE	FALSE	FALSE	3.39	9.80	6.68	51%	35%	68%		1.47	6.7	6.7	235.00				13,092				13,117	11,279	1,210	13,092			13,117	11,279	1,210
11/15/2011	FALSE	FALSE	FALSE	3.37	9.92	6.66	51%	34%	67%		1.49	6.7	6.6	218.00	188.00	0.86		12,109	10,442			13,050	11,159	1,210	12,109	10,442		13,050	11,159	1,210
11/16/2011	FALSE	FALSE	FALSE	3.36	9.89	6.72	50%	34%	68%		1.47	6.7	6.6									13,050	11,159	1,210				13,050	11,159	1,210
11/17/2011	FALSE	FALSE	FALSE	3.35	9.54	6.72	50%	35%	70%		1.42	6.7	6.6	210.00			20.85	11,769		1,169		13,104	11,159	1,201	11,769		1,169	13,104	11,159	1,201
11/18/2011	FALSE</																													

Date	Butte Break?	CSU Break?	Precip?	Min Influent Flow, mgd	Max Influent Flow, mgd	Avg Influent Flow, mgd	Min % of Avg	Min % of Max	Avg % of Max	Flow Outlier Type	Diurnal Peak Factor (DPF)	30-d Avg of Avg Flow, mgd	7-d Avg of Avg Flow, mgd	Influent TSS Conc., mg/L	Influent BOD Conc., mg/L	BOD/TSS Ratio	Influent NH3-N Conc., mg/L	Avg Inf TSS Load, ppd	Avg Inf BOD Load, ppd	Avg Inf NH3 Load, ppd	Load Outlier Type	30-d Avg of TSS Load, ppd	30-d Avg of BOD Load, ppd	30-d Avg of NH3-N Load, ppd	non-SN TSS Load, ppd	non-SN BOD Load, ppd	non-SN NH3 Load, ppd	30-d Avg of non-SN TSS Load, ppd	30-d Avg of non-SN BOD Load, ppd	30-d Avg of non-SN NH3-N Load, ppd
12/2/2011	FALSE	FALSE	FALSE	3.78	8.52	6.63	57%	44%	78%		1.29	6.6	6.5	231.00	209.00	0.90		12,773	11,556			12,287	11,223	1,192	12,773	11,556		12,287	11,223	1,192
12/3/2011	FALSE	FALSE	FALSE	3.67	9.10	6.60	56%	40%	73%		1.38	6.6	6.6									12,287	11,223	1,192				12,287	11,223	1,192
12/4/2011	FALSE	FALSE	FALSE	3.34	10.10	6.65	50%	33%	66%		1.52	6.6	6.7									12,287	11,223	1,199				12,287	11,223	1,199
12/5/2011	FALSE	FALSE	FALSE	3.31	9.29	6.71	49%	36%	72%		1.38	6.6	6.7	240.00				13,431				12,202	11,125	1,199	13,431			12,202	11,125	1,199
12/6/2011	FALSE	FALSE	FALSE	3.40	9.88	6.67	51%	34%	68%		1.48	6.6	6.7	209.00	189.00	0.90		11,626	10,514			12,166	11,038	1,199	11,626	10,514		12,166	11,038	1,199
12/7/2011	FALSE	FALSE	FALSE	3.33	9.41	6.73	49%	35%	72%		1.40	6.6	6.7									12,166	11,038	1,199				12,166	11,038	1,199
12/8/2011	FALSE	FALSE	FALSE	3.33	9.77	6.73	49%	34%	69%		1.45	6.6	6.7	202.00			24.19	11,338		1,358		11,784	11,038	1,231	11,338		1,358	11,784	11,038	1,231
12/9/2011	FALSE	FALSE	FALSE	4.03	8.39	7.41	54%	48%	88%	AvgMax	1.13	6.6	6.7									11,816	11,038	1,231				11,816	11,038	1,231
12/10/2011	FALSE	FALSE	FALSE	3.79	8.89	5.97	63%	43%	67%		1.49	6.6	6.6									11,918	11,201	1,231				11,918	11,201	1,231
12/11/2011	FALSE	FALSE	FALSE	3.52	9.38	6.67	53%	38%	71%		1.41	6.6	6.6									11,866	11,201	1,245				11,866	11,201	1,245
12/12/2011	FALSE	FALSE	FALSE	3.66	8.58	6.73	54%	43%	78%		1.27	6.6	6.6	202.00				11,338				11,829	11,201	1,245	11,338			11,829	11,201	1,245
12/13/2011	FALSE	FALSE	FALSE	3.68	8.61	6.76	54%	43%	79%		1.27	6.6	6.6	197.00	217.00	1.10		11,107	12,234			11,780	11,349	1,245	11,107	12,234		11,780	11,349	1,245
12/14/2011	FALSE	FALSE	FALSE	3.59	8.76	6.77	53%	41%	77%		1.29	6.6	6.6									11,780	11,349	1,245				11,780	11,349	1,245
12/15/2011	FALSE	FALSE	TRUE	3.68	8.58	6.68	55%	43%	78%		1.28	6.6	6.6				21.29			1,186		11,687	11,349	1,233			1,186	11,687	11,349	1,233
12/16/2011	TRUE	TRUE	FALSE	3.32	9.63	6.59	50%	34%	68%		1.46	6.6	6.6	230.00	245.00	1.07		12,641	13,465			11,725	11,781	1,233	12,417	13,364		11,709	11,766	1,233
12/17/2011	TRUE	TRUE	FALSE	3.33	9.89	6.39	52%	34%	65%		1.55	6.6	6.6									11,725	11,781	1,233				11,709	11,766	1,233
12/18/2011	TRUE	TRUE	FALSE	3.76	8.25	6.18	61%	46%	75%		1.33	6.6	6.6									11,721	11,781	1,249				11,704	11,766	1,249
12/19/2011	TRUE	TRUE	FALSE	3.74	8.14	6.33	59%	46%	78%		1.29	6.5	6.6	179.00				9,450				11,528	11,759	1,249	9,450			11,511	11,742	1,249
12/20/2011	TRUE	TRUE	FALSE	3.75	8.02	6.21	60%	47%	77%		1.29	6.5	6.5									11,528	11,759	1,249				11,511	11,742	1,249
12/21/2011	TRUE	TRUE	FALSE	3.35	8.48	5.98	56%	40%	71%		1.42	6.5	6.4	207.00			22.14	10,324		1,104		11,442	11,759	1,220	10,324		1,104	11,426	11,742	1,220
12/22/2011	TRUE	TRUE	FALSE	3.28	8.73	5.97	55%	38%	68%		1.46	6.5	6.3	233.00	239.00	1.03		11,601	11,900			11,605	11,779	1,268	11,601	11,900		11,589	11,765	1,268
12/23/2011	TRUE	TRUE	FALSE	3.60	8.45	6.16	58%	43%	73%		1.37	6.5	6.2									11,605	11,779	1,268				11,589	11,765	1,268
12/24/2011	TRUE	TRUE	FALSE	3.58	8.34	5.77	62%	43%	69%		1.45	6.5	6.1									11,571	11,944	1,268				11,553	11,928	1,268
12/25/2011	TRUE	TRUE	FALSE	3.40	6.60	5.19	66%	52%	79%		1.27	6.4	6.0									11,571	11,944	1,268				11,553	11,928	1,268
12/26/2011	TRUE	TRUE	FALSE	3.29	9.17	5.94	55%	36%	65%		1.54	6.4	5.9									11,571	11,944	1,268				11,553	11,928	1,268
12/27/2011	TRUE	TRUE	FALSE	3.35	8.99	6.08	55%	37%	68%		1.48	6.4	5.9	281.00	246.00	0.88		14,249	12,474			11,762	12,020	1,268	14,249	12,474		11,746	12,006	1,268
12/28/2011	TRUE	TRUE	FALSE	3.35	9.02	6.08	55%	37%	67%		1.48	6.4	5.9									11,762	12,020	1,268				11,746	12,006	1,268
12/29/2011	TRUE	TRUE	FALSE	3.40	10.29	6.14	55%	33%	60%		1.68	6.4	5.9	224.00			19.28	11,471		987		11,805	12,020	1,212	11,471		987	11,789	12,006	1,212
12/30/2011	TRUE	TRUE	FALSE	3.95	8.10	6.15	64%	49%	76%		1.32	6.4	5.9	270.00				13,849				11,861	12,024	1,212	13,849			11,845	12,007	1,212
12/31/2011	TRUE	TRUE	FALSE	3.68	7.97	6.12	60%	46%	77%		1.30	6.3	5.9									11,861	12,024	1,212				11,845	12,007	1,212
1/1/2012	TRUE	TRUE	FALSE	3.87	7.83	5.83	66%	49%	74%		1.34	6.3	5.9									11,938	12,024	1,159				11,921	12,007	1,159
1/2/2012	TRUE	TRUE	FALSE	3.90	7.70	6.26	62%	51%	81%		1.23	6.3	6.1									11,869	12,117	1,159				11,850	12,097	1,159
1/3/2012	TRUE	TRUE	FALSE	3.60	8.00	6.19	58%	45%	77%		1.29	6.3	6.1	236.00				12,183				11,893	12,117	1,159	12,183			11,876	12,097	1,159
1/4/2012	TRUE	TRUE	FALSE	3.60	8.00	6.25	58%	45%	78%		1.28	6.3	6.1									11,893	12,117	1,159				11,876	12,097	1,159
1/5/2012	TRUE	TRUE	FALSE	3.60	8.00	6.23	58%	45%	78%		1.28	6.3	6.1	261.00			21.03	13,561		1,093		11,903	12,117	1,146	13,561		1,093	11,886	12,097	1,146
1/6/2012	TRUE	TRUE	FALSE	3.33	8.83	6.15	54%	38%	70%		1.44	6.2	6.1	235.00	213.00	0.91		12,053	10,925			11,936	12,200	1,146	12,053	10,925		11,918	12,179	1,146
1/7/2012	TRUE	TRUE	FALSE	3.29	9.72	6.19	53%	34%	64%		1.57	6.2	6.2									11,936	12,200	1,146				11,918	12,179	1,146
1/8/2012	TRUE	TRUE	FALSE	3.41	8.36	6.20	55%	41%	74%		1.35	6.2	6.2									11,985	12,200	1,093				11,967	12,179	1,093
1/9/2012	TRUE	TRUE	FALSE	3.18	8.73	6.18	51%	36%	71%		1.41	6.2	6.2	227.00				11,700				11,963	12,200	1,093	11,700			11,946	12,179	1,093
1/10/2012	TRUE	TRUE	FALSE	3.38	11.17	6.14	55%	30%	55%	AvgMax	1.82	6.2	6.2	260.00	271.00	1.04		13,314	13,877			12,060	12,479	1,093	13,314	13,877		12,044	12,462	1,093
1/11/2012	TRUE	TRUE	FALSE	3.31	12.67	5.99	55%	26%	47%	AvgMax	2.12	6.2	6.2									12,060	12,479	1,093				12,044	12,462	1,093
1/12/2012	TRUE	TRUE	FALSE	3.31	8.71	5.96	56%	38%	68%		1.46	6.2	6.2				21.62			1,075		12,116	12,479	1,089			1,075	12,098	12,462	1,089
1/13/2012	TRUE	TRUE	FALSE	3.41	7.36	5.83	58%	46%	79%		1.26	6.1	6.1	276.00				13,420				12,293	12,528	1,089	13,420			12,276	12,508	1,089
1/14/2012	TRUE	TRUE	FALSE	3.38	8.21	5.84	58%	41%	71%		1.41	6.1	6.0									12,293	12,528	1,089				12,276	12,508	1,089
1/15/2012	TRUE	TRUE	FALSE	3.45	8.02	5.74	60%	43%	72%		1.40	6.1	6.0									12,293	12,528	1,065				12,276	12,508	1,065
1/16/2012	TRUE	TRUE	FALSE	3.44	8.57	6.21	55%	40%	72%		1.38	6.1	6.0									12,264	12,294	1,065				12,264	12,294	1,065
1/17/2012	TRUE	TRUE	FALSE	3.21	9.01	6.14	52%	36%	68%		1.47	6.1	6.0				23.37			1,197		12,264	12,294	1,091			1,197	12,264	12,294	1,091
1/18/2012	TRUE	TRUE	FALSE	3.32	8.97	6.18	54%	37%	69%		1.45	6.1	6.0									12,264	12,294	1,091				12,264	12,294	1,091
1/19/2012	TRUE	TRUE	TRUE	3.27	9.38	6.62	49%	35%	71%		1.42	6.1	6.1	261.00				14,410				12,678	12,294	1,091	14,293			12,668	12,294	1,091
1/20/2012	TRUE	TRUE	TRUE	3.94	12.60	9.19	43%	31%	73%		1.37	6.2	6.5	246.00	227.00	0.92		18,855	17,398			13,153	13,315	1,091	18,855	17,398		13,144	13,315	1,0

Date	Butte Break?	CSU Break?	Precip?	Min Influent Flow, mgd	Max Influent Flow, mgd	Avg Influent Flow, mgd	Min % of Avg	Min % of Max	Avg % of Max	Flow Outlier Type	Diurnal Peak Factor (DPF)	30-d Avg of Avg Flow, mgd	7-d Avg of Avg Flow, mgd	Influent TSS Conc., mg/L	Influent BOD Conc., mg/L	BOD/TSS Ratio	Influent NH3-N Conc., mg/L	Avg Inf TSS Load, ppd	Avg Inf BOD Load, ppd	Avg Inf NH3 Load, ppd	Load Outlier Type	30-d Avg of TSS Load, ppd	30-d Avg of BOD Load, ppd	30-d Avg of NH3-N Load, ppd	non-SN TSS Load, ppd	non-SN BOD Load, ppd	non-SN NH3 Load, ppd	30-d Avg of non-SN TSS Load, ppd	30-d Avg of non-SN BOD Load, ppd	30-d Avg of non-SN NH3-N Load, ppd
2/3/2012	FALSE	FALSE	FALSE	3.31	9.98	6.73	49%	33%	67%		1.48	7.0	7.0	225.00				12,629				13,228	12,054	1,214	12,629			13,219	12,054	1,214
2/4/2012	FALSE	FALSE	FALSE	3.21	10.37	6.56	49%	31%	63%		1.58	7.0	6.9									13,228	12,054	1,214			13,219	12,054	1,214	
2/5/2012	FALSE	FALSE	FALSE	3.27	10.44	6.43	51%	31%	62%		1.62	7.0	6.8									13,200	12,054	1,244			13,190	12,054	1,244	
2/6/2012	FALSE	FALSE	FALSE	3.27	9.91	6.64	49%	33%	67%		1.49	7.0	6.7	251.00				13,900				13,354	12,280	1,244	13,900		13,344	12,280	1,244	
2/7/2012	FALSE	FALSE	TRUE	3.46	10.15	6.81	51%	34%	67%		1.49	7.1	6.7	221.00	210.00	0.95		12,552	11,927			13,292	12,221	1,244	12,552	11,927	13,283	12,221	1,244	
2/8/2012	FALSE	FALSE	FALSE	3.44	9.77	6.69	51%	35%	68%		1.46	7.1	6.7									13,292	12,221	1,244			13,283	12,221	1,244	
2/9/2012	FALSE	FALSE	FALSE	3.35	9.80	6.63	51%	34%	68%		1.48	7.1	6.7	227.00			19.42	12,552		1,074		13,358	12,221	1,210	12,552		1,074	13,349	12,221	1,210
2/10/2012	FALSE	FALSE	TRUE	4.12	7.79	6.60	62%	53%	85%		1.18	7.1	6.6	306.00	219.00	0.72		16,843	12,055			13,629	11,917	1,210	16,843	12,055	13,620	11,917	1,210	
2/11/2012	FALSE	FALSE	FALSE	4.58	8.29	6.46	71%	55%	78%	inAvgMinM	1.28	7.1	6.6									13,629	11,917	1,210			13,620	11,917	1,210	
2/12/2012	FALSE	FALSE	TRUE	3.69	9.29	6.78	54%	40%	73%		1.37	7.1	6.7									13,629	11,917	1,244			13,620	11,917	1,244	
2/13/2012	FALSE	FALSE	TRUE	4.19	9.21	7.36	57%	45%	80%		1.25	7.2	6.8	218.00				13,381				13,626	11,917	1,244	13,381		13,617	11,917	1,244	
2/14/2012	FALSE	FALSE	FALSE	4.20	8.90	7.07	59%	47%	79%		1.26	7.2	6.8	208.00	195.00	0.94		12,264	11,498			13,529	11,857	1,244	12,264	11,498	13,520	11,857	1,244	
2/15/2012	FALSE	FALSE	FALSE	3.94	9.08	7.03	56%	43%	77%		1.29	7.3	6.9									13,529	11,857	1,244			13,520	11,857	1,244	
2/16/2012	FALSE	FALSE	FALSE	3.76	8.93	6.76	56%	42%	76%		1.32	7.3	6.9	211.00			17.46	11,896		984		13,420	11,857	1,192	11,896		984	13,412	11,857	1,192
2/17/2012	FALSE	FALSE	FALSE	3.34	10.04	6.70	50%	33%	67%		1.50	7.3	6.9	209.00	217.00	1.04		11,679	12,126			13,311	11,891	1,191	11,679	12,126	13,304	11,891	1,191	
2/18/2012	FALSE	FALSE	FALSE	3.34	10.31	6.50	51%	32%	63%		1.59	7.3	6.9									13,311	11,891	1,191			13,304	11,891	1,191	
2/19/2012	FALSE	FALSE	FALSE	3.23	10.12	6.39	51%	32%	63%		1.58	7.3	6.8									13,238	11,891	1,191			13,238	11,891	1,191	
2/20/2012	FALSE	FALSE	FALSE	3.60	9.30	6.86	52%	39%	74%		1.36	7.2	6.8									12,837	11,104	1,191			12,837	11,104	1,191	
2/21/2012	FALSE	FALSE	FALSE	3.35	10.09	6.65	50%	33%	66%		1.52	7.2	6.7	246.00	207.00	0.84		13,643	11,480			12,890	11,151	1,191	13,643	11,480	12,890	11,151	1,191	
2/22/2012	FALSE	FALSE	FALSE	3.40	10.00	6.57	52%	34%	66%		1.52	7.1	6.7									12,890	11,151	1,191			12,890	11,151	1,191	
2/23/2012	FALSE	FALSE	FALSE	3.40	10.00	6.56	52%	34%	66%		1.52	6.9	6.6	243.00			19.75	13,295		1,081		12,580	11,151	1,169	13,295		1,081	12,580	11,151	1,169
2/24/2012	FALSE	FALSE	FALSE	3.62	8.42	6.41	56%	43%	76%		1.31	6.9	6.6									12,717	11,512	1,169			12,717	11,512	1,169	
2/25/2012	FALSE	FALSE	FALSE	3.49	9.00	6.33	55%	39%	70%		1.42	6.8	6.5									12,717	11,512	1,169			12,717	11,512	1,169	
2/26/2012	FALSE	FALSE	FALSE	3.44	9.19	6.36	54%	37%	69%		1.44	6.8	6.5									12,717	11,512	1,232			12,717	11,512	1,232	
2/27/2012	FALSE	FALSE	FALSE	3.39	8.54	6.51	52%	40%	76%		1.31	6.7	6.5									12,801	11,605	1,232			12,801	11,605	1,232	
2/28/2012	FALSE	FALSE	FALSE	3.62	8.53	6.61	55%	42%	77%		1.29	6.7	6.5	239.00	216.00	0.90		13,175	11,908			12,828	11,648	1,232	13,175	11,908	12,828	11,648	1,232	
2/29/2012	FALSE	FALSE	TRUE	3.66	8.54	6.71	55%	43%	79%		1.27	6.7	6.5									12,828	11,648	1,232			12,828	11,648	1,232	
3/1/2012	FALSE	FALSE	TRUE	3.32	8.78	6.65	50%	38%	76%		1.32	6.7	6.5	230.00			21.14	12,756		1,172		13,044	11,648	1,220	12,756		1,172	13,044	11,648	1,220
3/2/2012	FALSE	FALSE	FALSE	3.50	8.70	6.55	53%	40%	75%		1.33	6.7	6.5	252.00	200.00	0.79		13,766	10,925			13,167	11,703	1,220	13,766	10,925	13,167	11,703	1,220	
3/3/2012	FALSE	FALSE	FALSE	3.50	8.80	6.30	56%	40%	72%		1.40	6.7	6.5									13,167	11,703	1,220			13,167	11,703	1,220	
3/4/2012	FALSE	FALSE	FALSE	3.30	9.03	6.31	52%	37%	70%		1.43	6.6	6.5									13,167	11,703	1,078			13,167	11,703	1,078	
3/5/2012	FALSE	FALSE	FALSE	3.50	8.40	6.56	53%	42%	78%		1.28	6.6	6.5									13,208	11,703	1,078			13,208	11,703	1,078	
3/6/2012	FALSE	FALSE	FALSE	3.60	8.30	6.52	55%	43%	79%		1.27	6.6	6.5	268.00	196.00	0.73		14,573	10,658			13,305	11,572	1,078	14,573	10,658	13,305	11,572	1,078	
3/7/2012	FALSE	FALSE	FALSE	3.60	8.50	6.49	55%	42%	76%		1.31	6.6	6.5									13,305	11,572	1,078			13,305	11,572	1,078	
3/8/2012	FALSE	FALSE	FALSE	3.50	8.60	6.40	55%	41%	74%		1.34	6.6	6.5				21.44			1,144		13,260	11,572	1,091			1,144	13,260	11,572	1,091
3/9/2012	FALSE	FALSE	FALSE	3.43	8.53	6.40	54%	40%	75%		1.33	6.6	6.4									13,319	11,521	1,091			13,319	11,521	1,091	
3/10/2012	FALSE	FALSE	FALSE	3.38	8.66	6.08	56%	39%	70%		1.42	6.6	6.4									13,319	11,521	1,091			13,319	11,521	1,091	
3/11/2012	FALSE	FALSE	FALSE	3.60	8.50	6.38	56%	42%	75%		1.33	6.6	6.4									13,388	11,521	1,095			13,388	11,521	1,095	
3/12/2012	FALSE	FALSE	FALSE	3.60	7.67	6.46	56%	47%	84%		1.19	6.6	6.4	265.00				14,277				13,155	11,432	1,095	14,277		13,155	11,432	1,095	
3/13/2012	FALSE	FALSE	TRUE	3.59	9.35	7.28	49%	38%	78%		1.28	6.6	6.5	238.00				14,450				13,263	11,432	1,095	14,450		13,263	11,432	1,095	
3/14/2012	FALSE	FALSE	TRUE	4.82	11.07	8.89	54%	44%	80%		1.25	6.7	6.8	238.00	208.00	0.87		17,646	15,422			13,600	12,002	1,095	17,646	15,422	13,600	12,002	1,095	
3/15/2012	FALSE	FALSE	TRUE	4.85	10.50	8.59	56%	46%	82%		1.22	6.7	7.1				13.50			967		13,618	12,002	1,070			967	13,618	12,002	1,070
3/16/2012	FALSE	TRUE	TRUE	5.41	11.33	8.58	63%	48%	76%		1.32	6.8	7.3	191.00	180.00	0.94		13,667	12,880			13,735	12,200	1,070	13,667	12,880	13,735	12,200	1,070	
3/17/2012	FALSE	TRUE	FALSE	4.33	11.76	8.02	54%	37%	68%		1.47	6.8	7.5									13,735	12,200	1,070			13,735	12,200	1,070	
3/18/2012	FALSE	FALSE	TRUE	3.82	12.74	8.08	47%	30%	63%		1.58	6.8	7.8									13,903	12,200	1,091			13,903	12,200	1,091	
3/19/2012	FALSE	FALSE	FALSE	3.71	11.63	7.72	48%	32%	66%		1.51	6.9	8.0	203.00				13,070				14,029	12,212	1,091	13,070		14,029	12,212	1,091	
3/20/2012	FALSE	FALSE	FALSE	3.57	9.95	7.11	50%	36%	71%		1.40	6.9	8.0	163.00	152.00	0.93		9,665	9,013			13,665	11,755	1,091	9,665	9,013	13,665	11,755	1,091	
3/21/2012	FALSE	FALSE	FALSE	3.57	9.69	6.86	52%	37%	71%		1.41	6.9	8.0									13,665	11,755	1,091			13,665	11,755	1,091	
3/22/2012	FALSE	FALSE	TRUE	3.39	9.56	6.71	51%	35%	70%		1.42	6.9	7.7	221.00			17.95	12,367		1,005		13,566	11,755	1,074	12,367		1,005	13,566	11,755	1,074
3/23/2012	FALSE	FALSE	FALSE	4.17	8.21	6.66	63%	51%	81%		1.23	6.9	7.5	216.00	198.00	0.92		11,998	10,998			13,439	11,686	1,074	11,998	10,998	13,439	11,686	1,074	
3/24/2012	FALSE	FALSE	FALSE	4.07	8.21	6.61	62%																							

Date	Butte Break?	CSU Break?	Precip?	Min Influent Flow, mgd	Max Influent Flow, mgd	Avg Influent Flow, mgd	Min % of Avg	Min % of Max	Avg % of Max	Flow Outlier Type	Diurnal Peak Factor (DPF)	30-d Avg of Avg Flow, mgd	7-d Avg of Avg Flow, mgd	Influent TSS Conc., mg/L	Influent BOD Conc., mg/L	BOD/TSS Ratio	Influent NH3-N Conc., mg/L	Avg Inf TSS Load, ppd	Avg Inf BOD Load, ppd	Avg Inf NH3 Load, ppd	Load Outlier Type	30-d Avg of TSS Load, ppd	30-d Avg of BOD Load, ppd	30-d Avg of NH3-N Load, ppd	non-SN TSS Load, ppd	non-SN BOD Load, ppd	non-SN NH3 Load, ppd	30-d Avg of non-SN TSS Load, ppd	30-d Avg of non-SN BOD Load, ppd	30-d Avg of non-SN NH3-N Load, ppd
4/6/2012	FALSE	FALSE	FALSE	3.66	9.80	7.15	51%	37%	73%		1.37	7.6	7.9	209.00	212.00	1.01		12,463	12,642			13,124	12,467	1,023	12,463	12,642		13,105	12,454	1,023
4/7/2012	FALSE	FALSE	FALSE	3.42	9.65	6.74	51%	35%	70%		1.43	7.6	7.6									13,124	12,467	1,023				13,105	12,454	1,023
4/8/2012	FALSE	FALSE	FALSE	3.50	9.20	6.50	54%	38%	71%		1.42	7.6	7.4									13,124	12,467	992				13,105	12,454	992
4/9/2012	FALSE	FALSE	FALSE	3.51	9.72	6.97	50%	36%	72%		1.39	7.6	7.2	190.00				11,045				12,994	12,467	992	11,045			12,977	12,454	992
4/10/2012	FALSE	FALSE	TRUE	3.49	9.44	6.99	50%	37%	74%		1.35	7.6	7.1	216.00	214.00	0.99		12,592	12,475			12,970	12,468	992	12,592	12,475		12,954	12,456	992
4/11/2012	FALSE	FALSE	TRUE	3.80	9.48	7.13	53%	40%	75%		1.33	7.6	7.0									12,970	12,468	992				12,954	12,456	992
4/12/2012	FALSE	FALSE	TRUE	3.56	10.46	7.37	48%	34%	70%		1.42	7.7	7.0	221.00			19.54	13,584		1,201		12,929	12,468	1,034	13,584		1,201	12,913	12,456	1,034
4/13/2012	FALSE	FALSE	TRUE	4.14	10.25	8.24	50%	40%	80%		1.24	7.7	7.1	199.00	195.00	0.98		13,676	13,401			12,884	12,561	1,034	13,676	13,401		12,868	12,551	1,034
4/14/2012	FALSE	FALSE	FALSE	4.40	10.24	7.57	58%	43%	74%		1.35	7.7	7.2									12,586	12,243	1,034				12,569	12,232	1,034
4/15/2012	FALSE	FALSE	FALSE	3.59	10.39	7.39	49%	35%	71%		1.41	7.6	7.3									12,586	12,243	1,051				12,569	12,232	1,051
4/16/2012	FALSE	FALSE	FALSE	3.61	9.94	7.21	50%	36%	73%		1.38	7.6	7.4	121.00			14.66	7,276		882		12,187	12,163	1,017	7,276		882	12,170	12,151	1,017
4/17/2012	FALSE	FALSE	FALSE	3.65	9.81	7.18	51%	37%	73%		1.37	7.6	7.4	199.00	199.00	1.00		11,916	11,916			12,171	12,136	1,017	11,916	11,916		12,155	12,125	1,017
4/18/2012	FALSE	FALSE	FALSE	3.54	9.58	7.00	51%	37%	73%		1.37	7.5	7.4									12,171	12,136	1,017				12,155	12,125	1,017
4/19/2012	FALSE	FALSE	FALSE	3.70	9.60	7.24	51%	39%	75%		1.33	7.5	7.4	288.00				17,390				12,425	12,136	1,017	17,390			12,409	12,125	1,017
4/20/2012	FALSE	FALSE	FALSE	3.50	9.20	6.84	51%	38%	74%		1.35	7.5	7.3	227.00	199.00	0.88		12,949	11,352			12,618	12,396	1,017	12,949	11,352		12,602	12,384	1,017
4/21/2012	FALSE	FALSE	FALSE	3.42	9.47	6.57	52%	36%	69%		1.44	7.5	7.1									12,618	12,396	1,017				12,602	12,384	1,017
4/22/2012	FALSE	FALSE	FALSE	3.42	9.39	6.69	51%	36%	71%		1.40	7.5	7.0									12,634	12,396	1,020				12,617	12,384	1,020
4/23/2012	FALSE	FALSE	FALSE	3.39	9.22	6.81	50%	37%	74%		1.35	7.5	6.9	225.00								12,683	12,571	1,020	12,779			12,665	12,558	1,020
4/24/2012	FALSE	FALSE	FALSE	3.54	8.55	6.73	53%	41%	79%		1.27	7.5	6.9	273.00	193.00	0.71		15,323	10,833			12,838	12,378	1,020	15,323	10,833		12,822	12,366	1,020
4/25/2012	FALSE	FALSE	TRUE	3.59	9.21	6.94	52%	39%	75%		1.33	7.5	6.9									12,838	12,378	1,020				12,822	12,366	1,020
4/26/2012	FALSE	FALSE	TRUE	3.94	9.52	7.15	55%	41%	75%		1.33	7.5	6.9				31.82			1,897		12,871	12,378	1,195			1,897	12,853	12,366	1,195
4/27/2012	FALSE	FALSE	FALSE	3.55	10.01	7.01	51%	35%	70%		1.43	7.5	6.8	215.00	192.00	0.89		12,570	11,225			12,785	12,060	1,195	12,570	11,225		12,768	12,048	1,195
4/28/2012	FALSE	FALSE	FALSE	3.48	9.60	6.60	53%	36%	69%		1.45	7.3	6.8									12,785	12,060	1,195				12,768	12,048	1,195
4/29/2012	FALSE	FALSE	FALSE	3.44	9.02	6.53	53%	38%	72%		1.38	7.2	6.8									12,728	12,060	1,316				12,710	12,048	1,316
4/30/2012	FALSE	FALSE	FALSE	3.46	8.72	6.74	51%	40%	77%		1.29	7.2	6.8									12,781	12,086	1,316				12,781	12,086	1,316
5/1/2012	FALSE	FALSE	FALSE	3.55	8.83	6.76	53%	40%	77%		1.31	7.1	6.8	277.00	212.00	0.77		15,617	11,952			12,970	12,071	1,316	15,617	11,952		12,970	12,071	1,316
5/2/2012	FALSE	FALSE	FALSE	3.51	8.99	6.82	51%	39%	76%		1.32	7.1	6.8									12,970	12,071	1,316				12,970	12,071	1,316
5/3/2012	FALSE	FALSE	FALSE	3.61	8.79	6.81	53%	41%	77%		1.29	7.0	6.8	204.00			20.13	11,586		1,143		12,924	12,071	1,282	11,586		1,143	12,924	12,071	1,282
5/4/2012	FALSE	FALSE	FALSE	3.60	9.20	6.64	54%	39%	72%		1.39	7.0	6.7	286.00	199.00	0.70		15,838	11,020			13,107	11,868	1,282	15,838	11,020		13,107	11,868	1,282
5/5/2012	FALSE	FALSE	FALSE	3.40	9.60	6.66	51%	35%	69%		1.44	7.0	6.7									13,107	11,868	1,282				13,107	11,868	1,282
5/6/2012	FALSE	FALSE	FALSE	3.47	9.25	6.59	53%	38%	71%		1.40	7.0	6.7									13,107	11,868	1,281				13,107	11,868	1,281
5/7/2012	FALSE	FALSE	FALSE	3.51	8.83	6.75	52%	40%	76%		1.31	6.9	6.7	208.00				11,709				13,057	11,772	1,281	11,709			13,057	11,772	1,281
5/8/2012	FALSE	FALSE	FALSE	3.47	9.23	6.72	52%	38%	73%		1.37	6.9	6.7	232.00	202.00	0.87		13,002	11,321			13,053	11,722	1,281	13,002	11,321		13,053	11,722	1,281
5/9/2012	FALSE	FALSE	FALSE	3.55	9.03	6.64	53%	39%	74%		1.36	6.9	6.7									13,053	11,722	1,281				13,053	11,722	1,281
5/10/2012	FALSE	FALSE	FALSE	3.49	8.86	6.64	53%	39%	75%		1.33	6.9	6.7	122.00			22.32	6,756		1,236		12,785	11,722	1,272	6,756		1,236	12,785	11,722	1,272
5/11/2012	FALSE	FALSE	FALSE	3.56	8.59	6.60	54%	41%	77%		1.30	6.9	6.7	273.00	210.00	0.77		15,027	11,559			12,937	11,620	1,272	15,027	11,559		12,937	11,620	1,272
5/12/2012	FALSE	FALSE	FALSE	3.57	8.83	6.38	56%	40%	72%		1.38	6.9	6.6									12,937	11,620	1,272				12,937	11,620	1,272
5/13/2012	FALSE	FALSE	FALSE	3.50	9.10	6.52	54%	38%	72%		1.40	6.9	6.6									12,894	11,620	1,290				12,894	11,620	1,290
5/14/2012	FALSE	FALSE	FALSE	3.50	8.50	6.68	52%	41%	79%		1.27	6.8	6.6	212.00				11,811				12,770	11,397	1,290	11,811			12,770	11,397	1,290
5/15/2012	FALSE	FALSE	FALSE	3.56	8.91	6.72	53%	40%	75%		1.33	6.8	6.6	231.00	170.00	0.74		12,946	9,528			12,781	11,190	1,290	12,946	9,528		12,781	11,190	1,290
5/16/2012	FALSE	FALSE	FALSE	3.55	8.90	6.74	53%	40%	76%		1.32	6.8	6.6									12,781	11,190	1,290				12,781	11,190	1,290
5/17/2012	FALSE	FALSE	FALSE	3.63	8.69	6.74	54%	42%	78%		1.29	6.8	6.6	284.00			21.07	15,964		1,184		13,324	11,190	1,365	15,964		1,184	13,324	11,190	1,365
5/18/2012	FALSE	FALSE	FALSE	3.55	8.76	6.65	53%	41%	76%		1.32	6.7	6.6	241.00	185.00	0.77		13,366	10,260			13,415	11,006	1,365	13,366	10,260		13,415	11,006	1,365
5/19/2012	FALSE	FALSE	FALSE	3.56	8.81	6.45	55%	40%	73%		1.37	6.7	6.6									13,415	11,006	1,365				13,415	11,006	1,365
5/20/2012	FALSE	FALSE	FALSE	3.51	8.85	6.47	54%	40%	73%		1.37	6.7	6.6									13,150	11,006	1,365				13,150	11,006	1,365
5/21/2012	FALSE	FALSE	FALSE	3.58	8.18	6.53	55%	44%	80%		1.25	6.7	6.6	238.00				12,962				13,150	10,962	1,365	12,962			13,150	10,962	1,365
5/22/2012	FALSE	FALSE	FALSE			6.42				gMinMaxA	0.00	6.7	6.6	218.00			20.79	11,672		1,113		13,058	10,962	1,315	11,672		1,113	13,058	10,962	1,315
5/23/2012	FALSE	FALSE	FALSE	3.56	8.25	6.37	56%	43%	77%		1.30	6.7	6.6									13,058	10,962	1,315				13,058	10,962	1,315
5/24/2012	FALSE	FALSE	FALSE	3.54	8.42	6.44	55%	42%	76%		1.31	6.7	6.5	225.00				12,085				13,015	10,962	1,315	12,085			13,015	10,962	1,315
5/25/2012	TRUE	FALSE	FALSE	3.80	8.02	6.30	60%	47%	79%																					

Date	Butte Break?	CSU Break?	Precip?	Min Influent Flow, mgd	Max Influent Flow, mgd	Avg Influent Flow, mgd	Min % of Avg	Min % of Max	Avg % of Max	Flow Outlier Type	Diurnal Peak Factor (DPF)	30-d Avg of Avg Flow, mgd	7-d Avg of Avg Flow, mgd	Influent TSS Conc., mg/L	Influent BOD Conc., mg/L	BOD/TSS Ratio	Influent NH3-N Conc., mg/L	Avg Inf TSS Load, ppd	Avg Inf BOD Load, ppd	Avg Inf NH3 Load, ppd	Load Outlier Type	30-d Avg of TSS Load, ppd	30-d Avg of BOD Load, ppd	30-d Avg of NH3-N Load, ppd	non-SN TSS Load, ppd	non-SN BOD Load, ppd	non-SN NH3 Load, ppd	30-d Avg of non-SN TSS Load, ppd	30-d Avg of non-SN BOD Load, ppd	30-d Avg of non-SN NH3-N Load, ppd
6/8/2012	TRUE	TRUE	FALSE	3.60	7.88	5.98	60%	46%	76%		1.32	6.3	6.1	218.00	204.00	0.94		10,872	10,174			11,637	10,122	1,112	10,872	10,174		11,637	10,122	1,112
6/9/2012	TRUE	TRUE	FALSE	3.51	7.92	5.74	61%	44%	72%		1.38	6.3	6.0									11,637	10,122	1,112				11,637	10,122	1,112
6/10/2012	TRUE	TRUE	FALSE	3.57	7.63	5.76	62%	47%	75%		1.32	6.3	6.0									11,963	10,122	1,081				11,963	10,122	1,081
6/11/2012	TRUE	TRUE	FALSE	3.63	7.91	6.07	60%	46%	77%		1.30	6.2	6.0	243.00				12,302				11,781	9,917	1,081	12,302			11,781	9,917	1,081
6/12/2012	TRUE	TRUE	FALSE	3.63	7.71	6.05	60%	47%	78%		1.27	6.2	6.0	238.00	197.00	0.83		12,009	9,940			11,795	9,920	1,081	12,009	9,940		11,795	9,920	1,081
6/13/2012	TRUE	TRUE	FALSE	3.72	7.46	6.04	62%	50%	81%		1.24	6.2	6.0									11,795	9,920	1,081				11,795	9,920	1,081
6/14/2012	TRUE	TRUE	FALSE	3.76	7.46	6.10	62%	50%	82%		1.22	6.2	6.0				23.26			1,183		11,794	9,920	1,102			1,183	11,794	9,920	1,102
6/15/2012	TRUE	TRUE	FALSE	3.32	7.39	6.01	55%	45%	81%		1.23	6.2	6.0	261.00	199.00	0.76		13,082	9,975			11,803	9,976	1,102	13,082	9,975		11,803	9,976	1,102
6/16/2012	TRUE	TRUE	FALSE	3.92	7.42	5.74	68%	53%	77%		1.29	6.1	5.9									11,803	9,976	1,102				11,803	9,976	1,102
6/17/2012	TRUE	TRUE	FALSE	3.61	7.51	5.72	63%	48%	76%		1.31	6.1	5.9									11,506	9,976	1,081				11,506	9,976	1,081
6/18/2012	TRUE	TRUE	FALSE	3.70	7.13	6.06	61%	52%	85%		1.18	6.1	6.0									11,363	9,935	1,081				11,363	9,935	1,081
6/19/2012	TRUE	TRUE	FALSE	3.80	7.13	5.81	65%	53%	81%		1.23	6.1	5.9	202.00	160.00	0.79		9,788	7,753			11,251	9,662	1,081	9,788	7,753		11,251	9,662	1,081
6/20/2012	TRUE	TRUE	FALSE	3.44	7.38	5.83	59%	47%	79%		1.27	6.0	5.9				23.10			1,123		11,251	9,662	1,090			1,123	11,251	9,662	1,090
6/21/2012	TRUE	TRUE	FALSE	3.68	7.08	5.87	63%	52%	83%		1.21	6.0	5.9	250.00				12,239				11,199	9,662	1,090	12,239			11,199	9,662	1,090
6/22/2012	TRUE	TRUE	FALSE	3.43	7.84	5.91	58%	44%	75%		1.33	6.0	5.9	218.00	188.00	0.86		10,745	9,266			11,133	9,618	1,084	10,745	9,266		11,133	9,618	1,084
6/23/2012	TRUE	TRUE	FALSE	3.46	7.38	5.62	62%	47%	76%		1.31	6.0	5.8									11,133	9,618	1,084				11,133	9,618	1,084
6/24/2012	TRUE	TRUE	FALSE	3.50	7.30	5.64	62%	48%	77%		1.29	6.0	5.8									11,060	9,618	1,084				11,060	9,618	1,084
6/25/2012	TRUE	TRUE	FALSE	3.30	7.50	5.77	57%	44%	77%		1.30	5.9	5.8	241.00				11,597				10,885	9,389	1,084	11,597			10,885	9,389	1,084
6/26/2012	TRUE	TRUE	FALSE	3.22	7.26	5.76	56%	44%	79%		1.26	5.9	5.8	250.00	201.00	0.80		12,010	9,656			10,965	9,419	1,084	11,626	9,537		10,938	9,405	1,084
6/27/2012	TRUE	TRUE	FALSE	3.30	7.30	5.75	57%	45%	79%		1.27	5.9	5.8									10,965	9,419	1,084				10,938	9,405	1,084
6/28/2012	TRUE	TRUE	FALSE	3.20	7.50	5.76	56%	43%	77%		1.30	5.9	5.8	241.00			20.83	11,577		1,001		11,006	9,419	1,067	11,577		1,001	10,980	9,405	1,067
6/29/2012	TRUE	TRUE	FALSE	3.23	7.60	5.75	56%	43%	76%		1.32	5.9	5.7	250.00	201.00	0.80		11,989	9,639			11,342	9,430	1,067	11,989	9,639		11,316	9,417	1,067
6/30/2012	TRUE	TRUE	FALSE	3.27	7.32	5.51	59%	45%	75%		1.33	5.9	5.7									11,342	9,430	1,067				11,316	9,417	1,067
7/1/2012	TRUE	TRUE	FALSE	3.20	7.42	5.50	58%	43%	74%		1.35	5.9	5.7									11,357	9,430	1,072				11,330	9,417	1,072
7/2/2012	TRUE	TRUE	FALSE	3.34	7.46	5.78	58%	45%	77%		1.29	5.9	5.7	224.00				10,798				11,592	9,488	1,072	10,798			11,565	9,473	1,072
7/3/2012	TRUE	TRUE	FALSE	3.30	7.40	5.61	59%	45%	76%		1.32	5.9	5.7	239.00	207.00	0.87		11,182	9,685			11,565	9,510	1,072	11,182	9,685		11,539	9,497	1,072
7/4/2012	TRUE	TRUE	FALSE	3.27	7.72	5.30	62%	42%	69%		1.46	5.8	5.6									11,565	9,510	1,072				11,539	9,497	1,072
7/5/2012	TRUE	TRUE	FALSE	3.32	7.19	5.60	59%	46%	78%		1.28	5.8	5.6				18.15			848		11,535	9,510	1,027			848	11,508	9,497	1,027
7/6/2012	TRUE	TRUE	FALSE	3.30	7.40	5.61	59%	45%	76%		1.32	5.8	5.6	212.00	188.00	0.89		9,919	8,796			11,436	9,432	1,027	9,919	8,796		11,409	9,418	1,027
7/7/2012	TRUE	TRUE	FALSE	3.30	7.40	5.43	61%	45%	73%		1.36	5.8	5.5									11,436	9,432	1,027				11,409	9,418	1,027
7/8/2012	TRUE	TRUE	FALSE	3.26	7.44	5.52	59%	44%	74%		1.35	5.8	5.5									11,436	9,432	1,039				11,409	9,418	1,039
7/9/2012	TRUE	TRUE	FALSE	3.37	7.55	5.88	57%	45%	78%		1.28	5.8	5.6	220.00				10,789				11,430	9,339	1,039	10,789			11,403	9,324	1,039
7/10/2012	TRUE	TRUE	FALSE	3.40	7.34	5.83	58%	46%	79%		1.26	5.8	5.6	176.00	143.00	0.81		8,558	6,953			11,239	9,074	1,039	8,558	6,953		11,213	9,060	1,039
7/11/2012	TRUE	TRUE	FALSE	3.65	7.40	5.85	62%	49%	79%		1.26	5.8	5.6									11,239	9,074	1,039				11,213	9,060	1,039
7/12/2012	TRUE	TRUE	FALSE	3.43	7.43	5.85	59%	46%	79%		1.27	5.8	5.7				17.19			839		11,163	9,074	999			839	11,136	9,060	999
7/13/2012	TRUE	TRUE	FALSE	3.55	7.62	5.84	61%	47%	77%		1.30	5.8	5.7	212.00	112.00	0.53		10,326	5,455			11,043	8,575	999	10,326	5,455		11,015	8,562	999
7/14/2012	TRUE	TRUE	FALSE	3.39	7.58	5.67	60%	45%	75%		1.34	5.7	5.7									11,043	8,575	999				11,015	8,562	999
7/15/2012	TRUE	TRUE	FALSE	3.50	7.40	5.65	62%	47%	76%		1.31	5.7	5.8									11,043	8,575	953				11,015	8,562	953
7/16/2012	TRUE	TRUE	FALSE	3.39	7.65	5.95	57%	44%	78%		1.29	5.7	5.8	165.00			20.13	8,188		999		10,693	8,400	962	8,188		999	10,666	8,385	962
7/17/2012	TRUE	TRUE	FALSE	3.60	7.20	5.95	61%	50%	83%		1.21	5.7	5.8	237.00				11,761				10,764	8,400	962	11,761			10,739	8,385	962
7/18/2012	TRUE	TRUE	FALSE	3.50	7.30	5.90	59%	48%	81%		1.24	5.7	5.8									10,764	8,400	962				10,739	8,385	962
7/19/2012	TRUE	TRUE	FALSE	3.68	7.27	5.88	63%	51%	81%		1.24	5.7	5.8	253.00								10,867	8,400	962	12,407			10,843	8,385	962
7/20/2012	TRUE	TRUE	FALSE	2.79	7.47	5.81	48%	37%	78%		1.29	5.7	5.8	273.00				13,228				11,082	8,493	962	13,228			11,058	8,476	962
7/21/2012	TRUE	TRUE	FALSE	3.38	7.47	5.57	61%	45%	75%		1.34	5.7	5.8									11,082	8,493	921				11,058	8,476	921
7/22/2012	TRUE	TRUE	FALSE	3.37	7.01	5.51	61%	48%	79%		1.27	5.7	5.8									11,005	8,493	921				10,979	8,476	921
7/23/2012	TRUE	TRUE	FALSE	3.37	7.23	5.91	57%	47%	82%		1.22	5.7	5.8									11,023	8,364	921				10,996	8,344	921
7/24/2012	TRUE	TRUE	FALSE	3.66	7.50	5.88	62%	49%	78%		1.28	5.7	5.8	229.00								11,037	8,364	921	11,106			11,003	8,344	921
7/25/2012	TRUE	TRUE	FALSE	3.54	7.16	5.84	61%	49%	82%		1.23	5.7	5.8									11,037	8,364	921				11,003	8,344	921
7/26/2012	TRUE	TRUE	FALSE	3.43	7.33	5.90	58%	47%	80%		1.24	5.7	5.8	226.00			18.77	11,121		924		11,005	8,364	922	11,121		924	10,971	8,344	922
7/27/2012	TRUE	TRUE	FALSE	3.71	7.51	5.84	64%	49%	78%		1.29	5.7	5.8	253.00	182.00	0.72		12,323	8,864			11,026	8,232	922	12,323	8,864		11,018	8,232	922
7/28/2012	TRUE	TRUE	FALSE	3.51	7.11	5.51	64%	49%	77%		1.29	5.7</																		

Date	Butte Break?	CSU Break?	Precip?	Min Influent Flow, mgd	Max Influent Flow, mgd	Avg Influent Flow, mgd	Min % of Avg	Min % of Max	Avg % of Max	Flow Outlier Type	Diurnal Peak Factor (DPF)	30-d Avg of Avg Flow, mgd	7-d Avg of Avg Flow, mgd	Influent TSS Conc., mg/L	Influent BOD Conc., mg/L	BOD/TSS Ratio	Influent NH3-N Conc., mg/L	Avg Inf TSS Load, ppd	Avg Inf BOD Load, ppd	Avg Inf NH3 Load, ppd	Load Outlier Type	30-d Avg of TSS Load, ppd	30-d Avg of BOD Load, ppd	30-d Avg of NH3-N Load, ppd	non-SN TSS Load, ppd	non-SN BOD Load, ppd	non-SN NH3 Load, ppd	30-d Avg of non-SN TSS Load, ppd	30-d Avg of non-SN BOD Load, ppd	30-d Avg of non-SN NH3-N Load, ppd
8/10/2012	TRUE	TRUE	FALSE	3.41	7.55	5.85	58%	45%	77%		1.29	5.8	5.9	222.00	186.00	0.84		10,831	9,075			11,774	7,988	963	10,831	9,075		11,766	7,988	963
8/11/2012	TRUE	TRUE	FALSE	3.35	7.53	5.63	60%	44%	75%		1.34	5.8	5.9									11,774	7,988	963				11,766	7,988	963
8/12/2012	TRUE	TRUE	FALSE	3.36	7.80	5.77	58%	43%	74%		1.35	5.8	5.9									11,774	7,988	994				11,766	7,988	994
8/13/2012	TRUE	TRUE	TRUE	3.30	7.68	6.04	55%	43%	79%		1.27	5.8	5.9	221.00				11,133				11,825	8,621	994	11,133			11,817	8,621	994
8/14/2012	TRUE	TRUE	FALSE	3.37	7.74	6.07	56%	44%	78%		1.28	5.8	5.9	219.00	178.00	0.81		11,087	9,011			11,781	8,699	994	11,087	9,011		11,774	8,699	994
8/15/2012	TRUE	TRUE	FALSE	3.28	7.63	6.03	54%	43%	79%		1.27	5.8	5.9									11,781	8,699	994				11,774	8,699	994
8/16/2012	TRUE	TRUE	FALSE	3.48	7.81	6.14	57%	45%	79%		1.27	5.9	5.9				21.39			1,095		12,006	8,699	1,018		1,095		11,998	8,699	1,018
8/17/2012	TRUE	TRUE	FALSE	3.40	8.00	6.12	56%	43%	77%		1.31	5.9	6.0	224.00	171.00	0.76		11,433	8,728			11,985	8,704	1,018	11,433	8,728		11,978	8,704	1,018
8/18/2012	TRUE	TRUE	FALSE	3.40	8.20	5.98	57%	41%	73%		1.37	5.9	6.0									11,985	8,704	1,018				11,978	8,704	1,018
8/19/2012	TRUE	TRUE	FALSE	3.30	8.25	6.19	53%	40%	75%		1.33	5.9	6.0									11,957	8,704	1,018				11,949	8,704	1,018
8/20/2012	TRUE	TRUE	FALSE	3.32	8.25	6.29	53%	40%	76%		1.31	5.9	6.1	187.00				9,810				11,729	8,704	1,018	9,810			11,721	8,704	1,018
8/21/2012	FALSE	TRUE	FALSE	3.42	8.44	6.33	54%	41%	75%		1.33	5.9	6.1	179.00	190.00	1.06		9,450	10,031			11,587	8,893	1,018	9,450	10,031		11,579	8,893	1,018
8/22/2012	FALSE	TRUE	FALSE	3.35	8.67	6.41	52%	39%	74%		1.35	5.9	6.2									11,587	8,893	1,018				11,579	8,893	1,018
8/23/2012	FALSE	TRUE	FALSE	3.42	8.43	6.44	53%	41%	76%		1.31	6.0	6.2									11,587	8,893	1,018				11,579	8,893	1,018
8/24/2012	FALSE	TRUE	FALSE	3.47	8.21	6.34	55%	42%	77%		1.29	6.0	6.3	79.00	148.00	1.87	20.12	4,177	7,826	1,064	TSS	11,611	8,760	1,027	4,177	7,826	1,064	11,611	8,760	1,027
8/25/2012	FALSE	TRUE	FALSE	3.53	8.62	6.30	56%	41%	73%		1.37	6.0	6.3									11,611	8,760	1,027				11,611	8,760	1,027
8/26/2012	FALSE	TRUE	FALSE	3.62	8.71	6.42	56%	42%	74%		1.36	6.0	6.3									11,646	8,760	1,053				11,646	8,760	1,053
8/27/2012	FALSE	TRUE	FALSE	3.51	8.35	6.52	54%	42%	78%		1.28	6.0	6.4	234.00				12,724				11,674	8,745	1,053	12,724			11,674	8,745	1,053
8/28/2012	FALSE	FALSE	FALSE	3.29	9.89	6.46	51%	33%	65%		1.53	6.1	6.4	192.00	171.00	0.89		10,344	9,213			11,586	8,803	1,053	10,344	9,213		11,586	8,803	1,053
8/29/2012	FALSE	FALSE	FALSE	3.29	9.89	6.48	51%	33%	66%		1.53	6.1	6.4									11,586	8,803	1,053				11,586	8,803	1,053
8/30/2012	FALSE	FALSE	FALSE	3.53	8.73	6.52	54%	40%	75%		1.34	6.1	6.4									11,331	8,803	1,053				11,331	8,803	1,053
8/31/2012	FALSE	FALSE	FALSE	3.45	8.81	6.55	53%	39%	74%		1.35	6.1	6.4	247.00	185.00	0.75	18.50	13,493	10,106	1,011		11,535	9,024	1,044	13,493	10,106	1,011	11,535	9,024	1,044
9/1/2012	FALSE	FALSE	FALSE	3.40	8.86	6.24	54%	38%	70%		1.42	6.1	6.4									11,535	9,024	1,044				11,535	9,024	1,044
9/2/2012	FALSE	FALSE	FALSE	3.39	8.73	6.04	56%	39%	69%		1.45	6.1	6.4									11,477	9,024	1,071				11,477	9,024	1,071
9/3/2012	FALSE	FALSE	FALSE	3.46	9.26	6.54	53%	37%	71%		1.42	6.2	6.4									11,322	9,024	1,071				11,322	9,024	1,071
9/4/2012	FALSE	FALSE	FALSE	3.45	8.56	6.42	54%	40%	75%		1.33	6.2	6.4	196.00	176.00	0.90		10,494	9,424			11,259	9,068	1,071	10,494	9,424		11,259	9,068	1,071
9/5/2012	FALSE	FALSE	FALSE	3.47	8.37	6.52	53%	41%	78%		1.28	6.2	6.4									11,259	9,068	1,071				11,259	9,068	1,071
9/6/2012	FALSE	FALSE	FALSE	3.52	8.54	6.51	54%	41%	76%		1.31	6.2	6.4	228.00			20.44	12,379		1,110		11,354	9,068	1,079	12,379		1,110	11,354	9,068	1,079
9/7/2012	FALSE	FALSE	FALSE	3.35	9.75	6.45	52%	34%	66%		1.51	6.2	6.4	240.00	181.00	0.75		12,910	9,737			11,311	9,239	1,079	12,910	9,737		11,311	9,239	1,079
9/8/2012	FALSE	FALSE	FALSE	3.36	9.62	6.30	53%	35%	65%		1.53	6.3	6.4									11,311	9,239	1,079				11,311	9,239	1,079
9/9/2012	FALSE	FALSE	FALSE	3.40	9.12	6.36	53%	37%	70%		1.43	6.3	6.4									11,341	9,239	1,070				11,341	9,239	1,070
9/10/2012	FALSE	FALSE	FALSE	3.39	8.68	6.49	52%	39%	75%		1.34	6.3	6.4	191.00				10,338				11,300	9,259	1,070	10,338			11,300	9,259	1,070
9/11/2012	FALSE	FALSE	FALSE	3.36	8.64	6.46	52%	39%	75%		1.34	6.3	6.4	213.00	172.00	0.81		11,476	9,267			11,313	9,260	1,070	11,476	9,267		11,313	9,260	1,070
9/12/2012	FALSE	FALSE	FALSE	3.42	8.60	6.47	53%	40%	75%		1.33	6.3	6.4									11,313	9,260	1,070				11,313	9,260	1,070
9/13/2012	FALSE	FALSE	FALSE	3.38	8.66	6.45	52%	39%	74%		1.34	6.3	6.4				19.48			1,048		11,328	9,260	1,065		1,048		11,328	9,260	1,065
9/14/2012	FALSE	FALSE	FALSE	3.55	8.21	6.40	55%	43%	78%		1.28	6.4	6.4	212.00	172.00	0.81		11,316	9,181			11,347	9,279	1,065	11,316	9,181		11,347	9,279	1,065
9/15/2012	FALSE	FALSE	FALSE	3.49	8.63	6.18	56%	40%	72%		1.40	6.4	6.4									11,347	9,279	1,065				11,347	9,279	1,065
9/16/2012	FALSE	FALSE	FALSE	3.20	9.10	6.30	51%	35%	69%		1.44	6.4	6.4									11,347	9,279	1,058				11,347	9,279	1,058
9/17/2012	FALSE	FALSE	FALSE	3.40	8.50	6.44	53%	40%	76%		1.32	6.4	6.4	217.00				11,655				11,366	9,348	1,058	11,655			11,366	9,348	1,058
9/18/2012	FALSE	FALSE	FALSE	3.45	8.38	6.42	54%	41%	77%		1.31	6.4	6.4	259.00	172.00	0.66		13,868	9,209			11,558	9,332	1,058	13,868	9,209		11,558	9,332	1,058
9/19/2012	FALSE	FALSE	FALSE	3.40	8.50	6.38	53%	40%	75%		1.33	6.4	6.4									11,558	9,332	1,058				11,558	9,332	1,058
9/20/2012	FALSE	FALSE	FALSE	3.10	8.60	6.30	49%	36%	73%		1.37	6.4	6.4	230.00			25.81	12,085		1,356		11,733	9,332	1,118	12,085		1,356	11,733	9,332	1,118
9/21/2012	FALSE	FALSE	FALSE	3.14	8.21	6.26	50%	38%	76%		1.31	6.4	6.3	241.00	189.00	0.78		12,582	9,867			11,974	9,314	1,118	12,582	9,867		11,974	9,314	1,118
9/22/2012	FALSE	FALSE	FALSE	3.18	8.47	5.90	54%	38%	70%		1.44	6.4	6.3									11,974	9,314	1,118				11,974	9,314	1,118
9/23/2012	FALSE	FALSE	FALSE	3.05	8.70	6.09	50%	35%	70%		1.43	6.4	6.3									11,974	9,314	1,118				11,974	9,314	1,118
9/24/2012	FALSE	FALSE	FALSE	3.32	8.88	6.36	52%	37%	72%		1.40	6.4	6.3	213.00				11,298				11,926	9,500	1,131	11,298			11,926	9,500	1,131
9/25/2012	FALSE	FALSE	FALSE	3.21	8.44	6.26	51%	38%	74%		1.35	6.4	6.2	220.00	181.00	0.82		11,486	9,450			11,897	9,495	1,131	11,235	9,363		11,880	9,485	1,131
9/26/2012	FALSE	FALSE	FALSE	3.20	8.49	6.26	51%	38%	74%		1.36	6.4	6.2									11,897	9,495	1,131				11,880	9,485	1,131
9/27/2012	FALSE	FALSE	FALSE	3.14	8.30	6.21	51%	38%	75%		1.34	6.4	6.2	224.00			22.00	11,601		1,139		11,822	9,495	1,133	11,601		1,139	11,805	9,485	1,133
9/28/2012	FALSE	FALSE	FALSE	3.20	8.10	6.07	53%	40%	75%		1.33	6.3	6.2	239.00	191.00	0.80		12,099	9,669			11,939	9,545	1,133	12,099	9,66				

Date	Butte Break?	CSU Break?	Precip?	Min Influent Flow, mgd	Max Influent Flow, mgd	Avg Influent Flow, mgd	Min % of Avg	Min % of Max	Avg % of Max	Flow Outlier Type	Diurnal Peak Factor (DPF)	30-d Avg of Avg Flow, mgd	7-d Avg of Avg Flow, mgd	Influent TSS Conc., mg/L	Influent BOD Conc., mg/L	BOD/TSS Ratio	Influent NH3-N Conc., mg/L	Avg Inf TSS Load, ppd	Avg Inf BOD Load, ppd	Avg Inf NH3 Load, ppd	Load Outlier Type	30-d Avg of TSS Load, ppd	30-d Avg of BOD Load, ppd	30-d Avg of NH3-N Load, ppd	non-SN TSS Load, ppd	non-SN BOD Load, ppd	non-SN NH3 Load, ppd	30-d Avg of non-SN TSS Load, ppd	30-d Avg of non-SN BOD Load, ppd	30-d Avg of non-SN NH3-N Load, ppd
10/12/2012	FALSE	FALSE	FALSE	3.09	9.47	6.32	49%	33%	67%		1.50	6.3	6.3									11,726	9,578	1,169				11,709	9,567	1,169
10/13/2012	FALSE	FALSE	FALSE	3.11	9.53	6.01	52%	33%	63%		1.59	6.2	6.2									11,726	9,578	1,169				11,709	9,567	1,169
10/14/2012	FALSE	FALSE	FALSE	3.87	9.49	6.14	63%	41%	65%		1.55	6.2	6.3									11,726	9,578	1,199				11,709	9,567	1,199
10/15/2012	FALSE	FALSE	FALSE	3.11	9.57	6.31	49%	32%	66%		1.52	6.2	6.3	184.00	220.00	1.20		9,683	11,578			11,617	9,877	1,199	9,683	11,578		11,600	9,867	1,199
10/16/2012	FALSE	FALSE	FALSE	3.15	9.57	6.29	50%	33%	66%		1.52	6.2	6.3	276.00				14,479				11,796	9,877	1,199	14,479			11,780	9,867	1,199
10/17/2012	FALSE	FALSE	FALSE	3.17	12.04	6.18	51%	26%	51%	AvgMax	1.95	6.2	6.3									11,796	9,877	1,199				11,780	9,867	1,199
10/18/2012	FALSE	FALSE	FALSE	3.19	8.96	6.15	52%	36%	69%		1.46	6.2	6.2				23.69			1,215		11,805	9,877	1,202			1,215	11,788	9,867	1,202
10/19/2012	FALSE	FALSE	FALSE	3.27	8.77	6.00	55%	37%	68%		1.46	6.2	6.2	218.00	199.00	0.91		10,909	9,958			11,608	9,971	1,202	10,909	9,958		11,591	9,960	1,202
10/20/2012	FALSE	FALSE	FALSE	3.35	8.63	5.70	59%	39%	66%		1.51	6.2	6.1									11,608	9,971	1,202				11,591	9,960	1,202
10/21/2012	FALSE	FALSE	FALSE	3.09	11.11	6.41	48%	28%	58%	AvgMax	1.73	6.2	6.1									11,574	9,971	1,164				11,556	9,960	1,164
10/22/2012	FALSE	FALSE	TRUE	3.17	10.15	6.55	48%	31%	65%		1.55	6.2	6.2	232.00	210.00	0.91		12,673	11,472			11,580	10,171	1,164	12,673	11,472		11,563	10,161	1,164
10/23/2012	FALSE	FALSE	FALSE	3.29	9.73	6.56	50%	34%	67%		1.48	6.2	6.2	214.00								11,589	10,171	1,164	11,708			11,572	10,161	1,164
10/24/2012	FALSE	FALSE	TRUE	3.17	9.86	6.56	48%	32%	67%		1.50	6.2	6.3									11,589	10,171	1,164				11,572	10,161	1,164
10/25/2012	FALSE	FALSE	FALSE	3.09	9.37	6.38	48%	33%	68%		1.47	6.2	6.3				22.79			1,213		11,610	10,171	1,173			1,213	11,592	10,161	1,173
10/26/2012	FALSE	FALSE	FALSE	3.13	8.89	6.28	50%	35%	71%		1.42	6.2	6.3	206.00	185.00	0.90		10,789	9,689			11,560	10,201	1,173	10,789	9,689		11,560	10,201	1,173
10/27/2012	FALSE	FALSE	FALSE	3.16	9.56	6.15	51%	33%	64%		1.55	6.2	6.3									11,560	10,201	1,173				11,560	10,201	1,173
10/28/2012	FALSE	FALSE	FALSE	3.20	9.60	6.17	52%	33%	64%		1.56	6.2	6.4									11,557	10,201	1,182				11,557	10,201	1,182
10/29/2012	FALSE	FALSE	FALSE	3.20	9.50	6.20	52%	34%	65%		1.53	6.2	6.4									11,512	10,277	1,182				11,512	10,277	1,182
10/30/2012	FALSE	FALSE	FALSE	3.20	9.40	6.14	52%	34%	65%		1.53	6.2	6.3	288.00	202.00	0.70		14,748	10,344			11,761	10,286	1,182	14,748	10,344		11,761	10,286	1,182
10/31/2012	FALSE	FALSE	TRUE	3.20	9.30	6.49	49%	34%	70%		1.43	6.3	6.3									11,761	10,286	1,182				11,761	10,286	1,182
11/1/2012	FALSE	FALSE	FALSE	3.20	9.30	6.50	49%	34%	70%		1.43	6.3	6.3				23.32			1,264		11,545	10,286	1,198			1,264	11,545	10,286	1,198
11/2/2012	FALSE	FALSE	TRUE	3.22	9.37	6.42	50%	34%	69%		1.46	6.3	6.3	236.00				12,636				12,023	10,756	1,198	12,636			12,023	10,756	1,198
11/3/2012	FALSE	FALSE	FALSE	3.10	9.67	6.35	49%	32%	66%		1.52	6.3	6.3									12,023	10,756	1,198				12,023	10,756	1,198
11/4/2012	FALSE	FALSE	FALSE	3.18	9.50	6.15	52%	33%	65%		1.54	6.3	6.3									12,023	10,756	1,213				12,023	10,756	1,213
11/5/2012	FALSE	FALSE	FALSE	3.13	9.43	6.32	50%	33%	67%		1.49	6.3	6.3	197.00				10,384				11,852	10,762	1,213	10,384			11,852	10,762	1,213
11/6/2012	FALSE	FALSE	FALSE	3.21	8.63	6.12	52%	37%	71%		1.41	6.3	6.3	313.00	212.00	0.68		15,976	10,821			12,169	10,770	1,213	15,976	10,821		12,169	10,770	1,213
11/7/2012	FALSE	FALSE	FALSE	3.16	8.80	6.21	51%	36%	71%		1.42	6.3	6.3									12,169	10,770	1,213				12,169	10,770	1,213
11/8/2012	FALSE	FALSE	TRUE	3.14	9.57	6.21	51%	33%	65%		1.54	6.3	6.3	254.00	213.00	0.84		13,155	11,032			12,350	10,803	1,213	13,155	11,032		12,350	10,803	1,213
11/9/2012	FALSE	FALSE	FALSE	3.21	9.04	6.42	50%	36%	71%		1.41	6.3	6.3	243.00			24.19	13,011		1,295		12,498	10,803	1,230	13,011		1,295	12,498	10,803	1,230
11/10/2012	FALSE	FALSE	FALSE	3.14	9.20	5.97	53%	34%	65%		1.54	6.3	6.2									12,498	10,803	1,230				12,498	10,803	1,230
11/11/2012	FALSE	FALSE	FALSE	3.10	8.90	5.88	53%	35%	66%		1.51	6.2	6.2									12,513	10,699	1,247				12,513	10,699	1,247
11/12/2012	FALSE	FALSE	FALSE	3.10	8.90	6.31	49%	35%	71%		1.41	6.2	6.2									12,513	10,699	1,247				12,513	10,699	1,247
11/13/2012	FALSE	FALSE	FALSE	3.12	9.15	6.25	50%	34%	68%		1.46	6.2	6.2	222.00	199.00	0.90		11,572	10,373			12,440	10,658	1,247	11,572	10,373		12,440	10,658	1,247
11/14/2012	FALSE	FALSE	FALSE	3.10	9.27	6.21	50%	33%	67%		1.49	6.3	6.2									12,440	10,658	1,247				12,440	10,658	1,247
11/15/2012	FALSE	FALSE	FALSE	3.04	9.05	6.16	49%	34%	68%		1.47	6.2	6.2	227.00			22.52	11,662		1,157		12,592	10,527	1,229	11,662		1,157	12,592	10,527	1,229
11/16/2012	FALSE	TRUE	TRUE	3.12	9.06	6.21	50%	34%	69%		1.46	6.2	6.2									12,435	10,527	1,229				12,435	10,527	1,229
11/17/2012	FALSE	TRUE	TRUE	3.54	11.66	7.51	47%	30%	64%		1.55	6.3	6.3									12,435	10,527	1,229				12,435	10,527	1,229
11/18/2012	FALSE	TRUE	FALSE	3.41	9.99	6.56	52%	34%	66%		1.52	6.3	6.4									12,435	10,527	1,232				12,435	10,527	1,232
11/19/2012	FALSE	TRUE	FALSE	3.32	10.60	6.44	52%	31%	61%		1.65	6.3	6.5	180.00				9,668				12,332	10,622	1,232	9,668			12,332	10,622	1,232
11/20/2012	FALSE	TRUE	TRUE	3.45	8.66	6.64	52%	40%	77%		1.30	6.3	6.5	177.00			22.80	9,802		1,263		12,137	10,622	1,238	9,802		1,263	12,137	10,622	1,238
11/21/2012	TRUE	TRUE	FALSE	3.41	9.21	6.53	52%	37%	71%		1.41	6.4	6.5	243.00	189.00	0.78		13,234	10,293			12,216	10,575	1,238	13,234	10,293		12,216	10,575	1,238
11/22/2012	TRUE	TRUE	FALSE	3.53	9.47	6.00	59%	37%	63%		1.58	6.3	6.5									12,180	10,425	1,238				12,180	10,425	1,238
11/23/2012	TRUE	TRUE	FALSE	3.54	8.67	6.27	56%	41%	72%		1.38	6.3	6.5									12,220	10,425	1,238				12,220	10,425	1,238
11/24/2012	TRUE	TRUE	TRUE	3.45	9.37	6.35	54%	37%	68%		1.48	6.3	6.5									12,220	10,425	1,238				12,220	10,425	1,238
11/25/2012	TRUE	TRUE	FALSE	3.50	9.06	6.67	52%	39%	74%		1.36	6.3	6.4									12,220	10,425	1,245				12,220	10,425	1,245
11/26/2012	TRUE	TRUE	FALSE	3.47	9.54	6.67	52%	36%	70%		1.43	6.3	6.4	208.00				11,571				12,285	10,572	1,245	11,571			12,285	10,572	1,245
11/27/2012	FALSE	FALSE	FALSE	3.24	8.72	6.33	51%	37%	73%		1.38	6.3	6.4	210.00			22.71	11,086		1,199		12,193	10,572	1,236	11,086		1,199	12,193	10,572	1,236
11/28/2012	FALSE	FALSE	TRUE	3.44	9.73	7.09	49%	35%	73%		1.37	6.4	6.5	288.00				17,030				12,538	10,572	1,236	17,030			12,538	10,572	1,236
11/29/2012	FALSE	FALSE	TRUE	3.47	13.15	8.32	42%	26%	63%	MinAvg	1.58	6.4	6.5	314.00	225.00	0.72		21,788	15,612		TSS	12,538	11,412	1,236	21,430	15,511		12,538	11,396	1,236
11/30/2012	FALSE	FALSE	TRUE	5.70	13.80	10.94	52%	41%	79%		1.26	6.5	7.2	265.00				24,178			TSS	12,368	11,626	1,2						

Date	Butte Break?	CSU Break?	Precip?	Min Influent Flow, mgd	Max Influent Flow, mgd	Avg Influent Flow, mgd	Min % of Avg	Min % of Max	Avg % of Max	Flow Outlier Type	Diurnal Peak Factor (DPF)	30-d Avg of Avg Flow, mgd	7-d Avg of Avg Flow, mgd	Influent TSS Conc., mg/L	Influent BOD Conc., mg/L	BOD/TSS Ratio	Influent NH3-N Conc., mg/L	Avg Inf TSS Load, ppd	Avg Inf BOD Load, ppd	Avg Inf NH3 Load, ppd	Load Outlier Type	30-d Avg of TSS Load, ppd	30-d Avg of BOD Load, ppd	30-d Avg of NH3-N Load, ppd	non-SN TSS Load, ppd	non-SN BOD Load, ppd	non-SN NH3 Load, ppd	30-d Avg of non-SN TSS Load, ppd	30-d Avg of non-SN BOD Load, ppd	30-d Avg of non-SN NH3-N Load, ppd
12/14/2012	FALSE	FALSE	FALSE	3.47	9.02	6.76	51%	38%	75%		1.33	7.6	7.2	232.00	180.00	0.78		13,080	10,148			12,451	11,398	1,139	13,080	10,148		12,451	11,381	1,139
12/15/2012	FALSE	FALSE	TRUE	3.29	10.16	6.65	49%	32%	65%		1.53	7.6	7.1									12,451	11,398	1,139				12,451	11,381	1,139
12/16/2012	TRUE	FALSE	TRUE	3.40	10.33	7.00	49%	33%	68%		1.48	7.6	7.0									12,512	11,398	1,135				12,512	11,381	1,135
12/17/2012	TRUE	FALSE	TRUE	3.55	9.41	7.20	49%	38%	77%		1.31	7.6	7.0	117.00				7,026				12,120	11,398	1,135	7,026			12,120	11,381	1,135
12/18/2012	TRUE	FALSE	FALSE	3.49	10.16	7.08	49%	34%	70%		1.44	7.6	7.0	227.00	172.00	0.76		13,404	10,156			12,206	11,220	1,135	13,404	10,156		12,206	11,206	1,135
12/19/2012	TRUE	FALSE	FALSE	3.42	9.59	7.00	49%	36%	73%		1.37	7.6	6.9				19.45			1,135		12,206	11,220	1,135			1,135	12,206	11,206	1,135
12/20/2012	TRUE	FALSE	TRUE	3.54	9.30	7.14	50%	38%	77%		1.30	7.7	7.0	240.00			22.11	14,291		1,317		12,514	11,220	1,165	14,291		1,317	12,514	11,206	1,165
12/21/2012	TRUE	TRUE	TRUE	6.27	16.18	12.48	50%	39%	77%		1.30	7.9	7.7	154.00	117.00	0.76		16,029	12,178			12,929	11,340	1,146	16,029	12,178		12,929	11,327	1,146
12/22/2012	TRUE	TRUE	TRUE	6.17	14.33	10.41	59%	43%	73%		1.38	8.0	8.1									12,907	11,490	1,146				12,907	11,475	1,146
12/23/2012	TRUE	TRUE	TRUE	6.17	16.18	11.31	55%	38%	70%		1.43	8.2	8.7									12,907	11,490	1,146				12,907	11,475	1,146
12/24/2012	TRUE	TRUE	FALSE	5.67	12.58	9.26	61%	45%	74%		1.36	8.3	9.0									12,907	11,490	1,146				12,907	11,475	1,146
12/25/2012	TRUE	TRUE	TRUE	5.17	11.16	8.72	59%	46%	78%		1.28	8.3	9.2									12,907	11,490	1,146				12,907	11,475	1,146
12/26/2012	TRUE	TRUE	TRUE	5.68	12.89	9.55	59%	44%	74%		1.35	8.4	9.5									12,907	11,490	1,146				12,907	11,475	1,146
12/27/2012	TRUE	TRUE	TRUE	5.48	10.99	8.64	63%	50%	79%		1.27	8.5	9.7	84.00			9.73	6,053		701		12,513	11,490	1,072	6,053		701	12,513	11,475	1,072
12/28/2012	TRUE	TRUE	TRUE	4.49	11.19	8.11	55%	40%	72%		1.38	8.6	9.8	165.00	145.00	0.88		11,160	9,807			12,519	11,279	1,046	11,160	9,807		12,519	11,267	1,046
12/29/2012	TRUE	TRUE	FALSE	3.81	11.16	7.61	50%	34%	68%		1.47	8.6	9.2									12,172	11,279	1,046				12,172	11,267	1,046
12/30/2012	TRUE	TRUE	FALSE	3.85	9.86	7.08	54%	39%	72%		1.39	8.5	8.8									12,172	10,660	1,046				12,172	10,660	1,046
12/31/2012	TRUE	TRUE	FALSE	3.59	10.42	7.14	50%	34%	69%		1.46	8.4	8.3	142.00				8,456				11,906	10,660	1,046	8,456			11,906	10,660	1,046
1/1/2013	TRUE	TRUE	FALSE	3.70	8.67	6.40	58%	43%	74%		1.35	8.3	7.9									11,906	10,660	1,046				11,906	10,660	1,046
1/2/2013	TRUE	TRUE	FALSE	3.60	8.69	6.72	54%	41%	77%		1.29	8.1	7.7									11,906	10,660	1,046				11,906	10,660	1,046
1/3/2013	TRUE	TRUE	FALSE	3.67	8.84	6.59	56%	42%	75%		1.34	8.0	7.3	188.00			15.99	10,333		879		11,783	10,660	1,018	10,333		879	11,783	10,660	1,018
1/4/2013	TRUE	TRUE	FALSE	3.51	8.73	6.46	54%	40%	74%		1.35	7.9	7.0	226.00	187.00	0.83		12,176	10,075			11,473	10,371	1,018	12,176	10,075		11,473	10,371	1,018
1/5/2013	TRUE	TRUE	TRUE	3.53	9.09	6.32	56%	39%	70%		1.44	7.8	6.8									11,473	10,371	1,018				11,473	10,371	1,018
1/6/2013	TRUE	TRUE	TRUE	3.43	8.96	6.45	53%	38%	72%		1.39	7.7	6.6									11,403	10,371	1,063				11,403	10,371	1,063
1/7/2013	TRUE	TRUE	FALSE	3.45	8.45	6.45	53%	41%	76%		1.31	7.7	6.6	208.00				11,189				11,362	10,489	1,063	11,189			11,362	10,489	1,063
1/8/2013	TRUE	TRUE	FALSE	3.43	8.36	6.32	54%	41%	76%		1.32	7.6	6.5	173.00				9,119				11,201	10,489	1,063	9,119			11,201	10,489	1,063
1/9/2013	TRUE	TRUE	TRUE	3.40	8.40	6.32	54%	40%	75%		1.33	7.6	6.5	255.00	216.00	0.85		13,441	11,385			11,351	10,617	1,063	13,441	11,385		11,351	10,617	1,063
1/10/2013	TRUE	TRUE	TRUE	3.24	8.70	6.25	52%	37%	72%		1.39	7.6	6.4	228.00			20.56	11,885		1,072		11,448	10,617	1,064	11,885		1,072	11,448	10,617	1,064
1/11/2013	TRUE	TRUE	FALSE	3.40	8.60	6.11	56%	40%	71%		1.41	7.5	6.3	269.00	187.00	0.70		13,708	9,529			11,423	10,468	1,064	13,708	9,529		11,423	10,468	1,064
1/12/2013	TRUE	TRUE	FALSE	3.40	8.40	6.01	57%	40%	72%		1.40	7.5	6.3									11,423	10,468	1,064				11,423	10,468	1,064
1/13/2013	TRUE	TRUE	FALSE	3.23	8.66	6.08	53%	37%	70%		1.42	7.5	6.2									11,423	10,468	1,021				11,423	10,468	1,021
1/14/2013	TRUE	TRUE	FALSE	3.24	7.94	6.12	53%	41%	77%		1.30	7.5	6.2	184.00				9,392				11,177	10,522	1,021	9,392			11,177	10,522	1,021
1/15/2013	TRUE	TRUE	FALSE	3.27	8.72	6.10	54%	38%	70%		1.43	7.4	6.2	240.00				12,210				11,242	10,522	1,021	12,210			11,242	10,522	1,021
1/16/2013	TRUE	TRUE	FALSE	3.43	8.24	6.10	56%	42%	74%		1.35	7.4	6.1									11,242	10,522	1,021				11,242	10,522	1,021
1/17/2013	TRUE	TRUE	FALSE	3.33	8.04	6.14	54%	41%	76%		1.31	7.4	6.1	231.00			24.10	11,829		1,234		11,542	10,522	1,056	11,829		1,234	11,542	10,522	1,056
1/18/2013	TRUE	TRUE	FALSE	3.33	7.92	6.05	55%	42%	76%		1.31	7.3	6.1	313.00	189.00	0.60		15,793	9,536			11,691	10,418	1,056	15,793	9,536		11,691	10,418	1,056
1/19/2013	TRUE	TRUE	FALSE	3.23	8.60	5.99	54%	38%	70%		1.44	7.3	6.1									11,691	10,418	1,040				11,691	10,418	1,040
1/20/2013	TRUE	TRUE	FALSE	3.21	8.57	5.80	55%	37%	68%		1.48	7.3	6.0									11,518	10,418	971				11,518	10,418	971
1/21/2013	TRUE	TRUE	FALSE	3.30	8.70	6.33	52%	38%	73%		1.37	7.1	6.1									11,196	10,067	971				11,196	10,067	971
1/22/2013	TRUE	TRUE	FALSE	3.30	8.20	6.09	54%	40%	74%		1.35	6.9	6.1	373.00				18,945				11,712	10,067	971	18,945			11,712	10,067	971
1/23/2013	TRUE	TRUE	TRUE	3.30	8.20	6.33	52%	40%	77%		1.30	6.8	6.1									11,712	10,067	971				11,712	10,067	971
1/24/2013	FALSE	TRUE	TRUE	3.30	8.60	6.34	52%	38%	74%		1.36	6.7	6.1									11,712	10,067	971				11,712	10,067	971
1/25/2013	FALSE	TRUE	TRUE	3.34	8.60	6.33	53%	39%	74%		1.36	6.6	6.2	289.00	270.00	0.93	32.40	15,257	14,254	1,710		11,934	10,764	1,119	15,257	14,254	1,710	11,934	10,764	1,119
1/26/2013	FALSE	TRUE	TRUE	3.38	9.48	6.32	53%	36%	67%		1.50	6.5	6.2									11,934	10,764	1,119				11,934	10,764	1,119
1/27/2013	FALSE	TRUE	FALSE	3.40	9.43	6.56	52%	36%	70%		1.44	6.4	6.3									12,326	10,764	1,224				12,326	10,764	1,224
1/28/2013	FALSE	TRUE	FALSE	3.30	8.89	6.57	50%	37%	74%		1.35	6.4	6.4	222.00				12,164				12,393	10,956	1,224	12,164			12,393	10,956	1,224
1/29/2013	FALSE	FALSE	FALSE	3.37	8.71	6.48	52%	39%	74%		1.34	6.3	6.4	226.00	197.00	0.87		12,214	10,647			12,382	10,904	1,224	11,618	10,408		12,344	10,865	1,224
1/30/2013	FALSE	FALSE	FALSE	3.35	8.95	6.39	52%	37%	71%		1.40	6.3	6.4	268.00				14,282				12,494	10,904	1,224	14,282			12,458	10,865	1,224
1/31/2013	FALSE	FALSE	FALSE	3.35	8.84	6.40	52%	38%	72%		1.38	6.3	6.4				33.08			1,766		12,746	10,904	1,332			1,766	12,709	10,865	1,332
2/1/2013	FALSE	FALSE	FALSE	3.28	8.88	6.33	52%	37%	71%		1.40	6.3	6.4	351.00	249.00	0.71		18												

Date	Butte Break?	CSU Break?	Precip?	Min Influent Flow, mgd	Max Influent Flow, mgd	Avg Influent Flow, mgd	Min % of Avg	Min % of Max	Avg % of Max	Flow Outlier Type	Diurnal Peak Factor (DPF)	30-d Avg of Avg Flow, mgd	7-d Avg of Avg Flow, mgd	Influent TSS Conc., mg/L	Influent BOD Conc., mg/L	BOD/TSS Ratio	Influent NH3-N Conc., mg/L	Avg Inf TSS Load, ppd	Avg Inf BOD Load, ppd	Avg Inf NH3 Load, ppd	Load Outlier Type	30-d Avg of TSS Load, ppd	30-d Avg of BOD Load, ppd	30-d Avg of NH3-N Load, ppd	non-SN TSS Load, ppd	non-SN BOD Load, ppd	non-SN NH3 Load, ppd	30-d Avg of non-SN TSS Load, ppd	30-d Avg of non-SN BOD Load, ppd	30-d Avg of non-SN NH3-N Load, ppd
2/15/2013	FALSE	FALSE	FALSE	3.26	9.35	6.26	52%	35%	67%		1.49	6.3	6.3	228.00				11,904				14,736	12,030	1,526	11,904			14,690	11,996	1,526
2/16/2013	FALSE	FALSE	FALSE	3.18	9.21	6.03	53%	35%	65%		1.53	6.3	6.2									14,736	12,030	1,526			14,690	11,996	1,526	
2/17/2013	FALSE	FALSE	FALSE	3.18	9.25	6.00	53%	34%	65%		1.54	6.3	6.2									14,978	12,030	1,599			14,928	11,996	1,599	
2/18/2013	FALSE	FALSE	FALSE	3.27	6.52	6.56	50%	50%	101%	AvgMax	0.99	6.3	6.2									14,904	12,445	1,599			14,850	12,405	1,599	
2/19/2013	FALSE	FALSE	TRUE	3.23	6.36	6.39	51%	51%	100%	AvgMax	1.00	6.3	6.2	256.00	235.00	0.92		13,643	12,524			14,799	12,456	1,599	13,643	12,524	14,749	12,422	1,599	
2/20/2013	FALSE	FALSE	TRUE	3.18	6.17	6.22	51%	52%	101%	AvgMax	0.99	6.3	6.2									14,799	12,456	1,599			14,749	12,422	1,599	
2/21/2013	FALSE	FALSE	FALSE	3.25	8.76	6.26	52%	37%	71%		1.40	6.3	6.2	240.00			26.02	12,530		1,358		14,624	12,456	1,551	12,530		1,358	14,578	12,422	1,551
2/22/2013	FALSE	FALSE	FALSE	3.30	8.60	6.20	53%	38%	72%		1.39	6.3	6.2	244.00	224.00	0.92		12,617	11,583			14,137	12,347	1,551	12,617	11,583	14,091	12,317	1,551	
2/23/2013	FALSE	FALSE	FALSE	3.20	9.10	6.07	53%	35%	67%		1.50	6.3	6.1									14,137	12,347	1,551			14,091	12,317	1,551	
2/24/2013	FALSE	FALSE	FALSE	3.25	8.96	6.23	52%	36%	70%		1.44	6.3	6.2									14,137	12,347	1,551			14,091	12,317	1,551	
2/25/2013	FALSE	FALSE	FALSE	3.22	8.86	6.24	52%	36%	70%		1.42	6.3	6.2	256.00				13,323				13,989	12,075	1,511	13,323		13,943	12,041	1,511	
2/26/2013	FALSE	FALSE	FALSE	3.07	9.08	6.24	49%	34%	69%		1.46	6.3	6.2	237.00	234.00	0.99		12,334	12,178			13,870	12,088	1,511	12,135	12,087	13,814	12,047	1,511	
2/27/2013	FALSE	FALSE	FALSE	3.24	9.37	6.22	52%	35%	66%		1.51	6.3	6.2									13,870	12,088	1,511			13,814	12,047	1,511	
2/28/2013	FALSE	FALSE	FALSE	3.24	8.53	6.16	53%	38%	72%		1.38	6.3	6.2	268.00			21.52	13,768		1,106		13,985	12,088	1,430	13,768		1,106	13,928	12,047	1,430
3/1/2013	FALSE	FALSE	FALSE	3.24	8.44	6.14	53%	38%	73%		1.37	6.3	6.2	148.00	189.00	1.28		7,579	9,678			13,654	11,967	1,430	7,579	9,678	13,640	11,955	1,430	
3/2/2013	FALSE	FALSE	FALSE	3.22	8.94	6.08	53%	36%	68%		1.47	6.3	6.2									13,605	11,967	1,430			13,590	11,955	1,430	
3/3/2013	FALSE	FALSE	TRUE			6.13				gMinMaxA	0.00	6.2	6.2									13,605	11,967	1,346			13,590	11,955	1,346	
3/4/2013	FALSE	FALSE	FALSE	3.30	6.20	6.28	53%	53%	101%	AvgMax	0.99	6.2	6.2	112.00								12,631	11,798	1,346	5,866		12,616	11,785	1,346	
3/5/2013	FALSE	FALSE	TRUE	3.27	8.79	6.32	52%	37%	72%		1.39	6.2	6.2	220.00	194.00	0.88		11,596	10,226			12,557	11,602	1,346	11,596	10,226	12,543	11,590	1,346	
3/6/2013	FALSE	FALSE	TRUE	3.20	8.80	6.41	50%	36%	73%		1.37	6.3	6.2									12,557	11,602	1,346			12,543	11,590	1,346	
3/7/2013	FALSE	FALSE	FALSE	3.30	8.90	6.36	52%	37%	71%		1.40	6.3	6.2	255.00			24.60	13,526		1,305		12,412	11,602	1,337	13,526		1,305	12,398	11,590	1,337
3/8/2013	FALSE	FALSE	FALSE	3.21	11.31	6.33	51%	28%	56%	AvgMax	1.79	6.2	6.3	276.00	213.00	0.77		14,571	11,245			12,288	11,492	1,337	14,571	11,245	12,274	11,481	1,337	
3/9/2013	FALSE	FALSE	FALSE	3.20	9.53	5.99	53%	34%	63%		1.59	6.2	6.2									12,288	11,492	1,337			12,274	11,481	1,337	
3/10/2013	FALSE	FALSE	FALSE	3.31	8.74	6.11	54%	38%	70%		1.43	6.2	6.2									12,288	11,492	1,259			12,274	11,481	1,259	
3/11/2013	FALSE	FALSE	FALSE	3.27	8.32	6.25	52%	39%	75%		1.33	6.2	6.2	211.00				10,998				12,202	11,351	1,259	10,998		12,189	11,338	1,259	
3/12/2013	FALSE	FALSE	FALSE	3.21	8.88	6.21	52%	36%	70%		1.43	6.2	6.2	144.00	118.00	0.82		7,458	6,111			11,906	10,696	1,259	7,458	6,111	11,893	10,685	1,259	
3/13/2013	FALSE	FALSE	FALSE	3.22	8.77	6.15	52%	37%	70%		1.43	6.2	6.2									11,906	10,696	1,259			11,893	10,685	1,259	
3/14/2013	FALSE	FALSE	FALSE	3.23	8.85	6.27	52%	36%	71%		1.41	6.2	6.2	279.00			24.13	14,589		1,262		12,019	10,696	1,259	14,589		1,262	12,006	10,685	1,259
3/15/2013	TRUE	FALSE	FALSE	3.18	8.42	6.04	53%	38%	72%		1.39	6.2	6.1	254.00				12,795				11,818	10,506	1,259	12,795		11,806	10,493	1,259	
3/16/2013	TRUE	FALSE	FALSE	3.13	8.30	5.63	56%	38%	68%		1.47	6.2	6.1									11,818	10,506	1,259			11,806	10,493	1,259	
3/17/2013	TRUE	FALSE	FALSE	3.06	8.66	5.47	56%	35%	63%		1.58	6.1	6.0									11,818	10,506	1,258			11,806	10,493	1,258	
3/18/2013	TRUE	FALSE	FALSE	3.12	8.51	5.61	56%	37%	66%		1.52	6.1	6.0	359.00				16,797				12,124	10,506	1,258	16,797		12,112	10,493	1,258	
3/19/2013	TRUE	FALSE	TRUE	3.08	8.67	5.74	54%	36%	66%		1.51	6.1	5.9	269.00	223.00	0.83	22.66	12,877	10,675	1,085		12,169	10,527	1,223	12,877	10,675	1,085	12,157	10,516	1,223
3/20/2013	TRUE	FALSE	TRUE	3.13	8.44	5.81	54%	37%	69%		1.45	6.1	5.8									12,169	10,527	1,223			12,157	10,516	1,223	
3/21/2013	TRUE	FALSE	FALSE	3.18	8.29	5.67	56%	38%	68%		1.46	6.1	5.8	267.00				12,626				12,194	10,527	1,223	12,626		12,183	10,516	1,223	
3/22/2013	TRUE	FALSE	FALSE	3.19	8.25	5.68	56%	39%	69%		1.45	6.1	5.7	296.00	218.00	0.74		14,022	10,327			12,215	10,253	1,223	14,022	10,327	12,204	10,241	1,223	
3/23/2013	TRUE	FALSE	FALSE	3.07	8.00	5.54	55%	38%	69%		1.44	6.0	5.6									12,215	10,253	1,223			12,204	10,241	1,223	
3/24/2013	TRUE	FALSE	FALSE	3.08	8.76	5.85	53%	35%	67%		1.50	6.0	5.7									12,197	10,253	1,189			12,185	10,241	1,189	
3/25/2013	TRUE	FALSE	FALSE	3.19	8.84	6.20	51%	36%	70%		1.43	6.0	5.8									12,170	10,063	1,189			12,158	10,050	1,189	
3/26/2013	TRUE	FALSE	FALSE	3.26	8.69	6.20	53%	38%	71%		1.40	6.0	5.8	298.00	234.00	0.79		15,409	12,100			12,361	10,317	1,189	14,737	11,921	12,310	10,284	1,189	
3/27/2013	FALSE	FALSE	FALSE	3.13	9.10	6.23	50%	34%	68%		1.46	6.0	5.9									12,361	10,317	1,189			12,310	10,284	1,189	
3/28/2013	FALSE	FALSE	FALSE	3.11	9.29	6.21	50%	33%	67%		1.50	6.0	5.9	243.00			25.60	12,585		1,326		12,317	10,317	1,217	12,585		1,326	12,266	10,284	1,217
3/29/2013	FALSE	FALSE	FALSE	3.28	8.77	6.18	53%	37%	70%		1.42	6.0	6.0	251.00	211.00	0.84		12,937	10,875			12,353	10,155	1,217	12,937	10,875	12,313	10,132	1,217	
3/30/2013	FALSE	FALSE	FALSE	3.23	9.39	5.99	54%	34%	64%		1.57	6.0	6.1									12,353	10,155	1,217			12,313	10,132	1,217	
3/31/2013	FALSE	FALSE	FALSE	3.28	9.47	6.03	54%	35%	64%		1.57	6.0	6.1									12,264	10,155	1,244			12,222	10,132	1,244	
4/1/2013	FALSE	FALSE	TRUE	3.38	9.92	6.65	51%	34%	67%		1.49	6.0	6.2	293.00				16,250				12,806	10,223	1,244	16,250		12,764	10,197	1,244	
4/2/2013	FALSE	FALSE	FALSE	3.30	9.22	6.51	51%	36%	71%		1.42	6.0	6.3	239.00	206.00	0.86		12,976	11,184			12,816	10,343	1,244	12,976	11,184	12,777	10,321	1,244	
4/3/2013	FALSE	FALSE	FALSE	3.26	6.43	6.39	51%	51%	99%	AvgMax	1.01	6.0	6.3									12,816	10,343	1,244			12,777	10,321	1,244	
4/4/2013	FALSE	FALSE	TRUE	3.34	6.61	6.65	50%	51%	101%	AvgMax	0.99	6.0	6.3				25.02			1,388		13,251	10,343	1,273			13,209	10,321	1,273	
4/5/2013	FALSE	FALSE	FALSE	3.20	9.40	6.44	50%	34%	69%		1.46	6.1	6.3	301.00	215.00	0.71		16,167	11,548			13,536	10,508	1,273	16,167	11,548	13,494	10,486	1,273	

Date	Butte Break?	CSU Break?	Precip?	Min Influent Flow, mgd	Max Influent Flow, mgd	Avg Influent Flow, mgd	Min % of Avg	Min % of Max	Avg % of Max	Flow Outlier Type	Diurnal Peak Factor (DPF)	30-d Avg of Avg Flow, mgd	7-d Avg of Avg Flow, mgd	Influent TSS Conc., mg/L	Influent BOD Conc., mg/L	BOD/TSS Ratio	Influent NH3-N Conc., mg/L	Avg Inf TSS Load, ppd	Avg Inf BOD Load, ppd	Avg Inf NH3 Load, ppd	Load Outlier Type	30-d Avg of TSS Load, ppd	30-d Avg of BOD Load, ppd	30-d Avg of NH3-N Load, ppd	non-SN TSS Load, ppd	non-SN BOD Load, ppd	non-SN NH3 Load, ppd	30-d Avg of non-SN TSS Load, ppd	30-d Avg of non-SN BOD Load, ppd	30-d Avg of non-SN NH3-N Load, ppd
4/19/2013	FALSE	FALSE	FALSE	3.21	8.72	6.10	53%	37%	70%		1.43	6.1	6.2	260.00				13,227				13,866	10,960	1,285	13,227			13,824	10,938	1,285
4/20/2013	FALSE	FALSE	FALSE	3.19	8.32	5.82	55%	38%	70%		1.43	6.1	6.1									13,866	10,960	1,285			13,824	10,938	1,285	
4/21/2013	FALSE	FALSE	FALSE	3.20	8.81	6.00	53%	36%	68%		1.47	6.2	6.1									13,948	10,960	1,285			13,904	10,938	1,285	
4/22/2013	FALSE	FALSE	FALSE	3.34	8.78	6.18	54%	38%	70%		1.42	6.2	6.1	174.00				8,968				13,612	11,051	1,285	8,968		13,567	11,025	1,285	
4/23/2013	FALSE	FALSE	FALSE	3.25	8.74	6.21	52%	37%	71%		1.41	6.2	6.1	293.00	242.00	0.83		15,175	12,534			13,709	11,236	1,285	15,175	12,534	13,667	11,214	1,285	
4/24/2013	FALSE	FALSE	FALSE	3.28	8.75	6.18	53%	37%	71%		1.42	6.2	6.1									13,709	11,236	1,285			13,667	11,214	1,285	
4/25/2013	FALSE	FALSE	FALSE	3.23	9.11	6.24	52%	35%	68%		1.46	6.2	6.1	187.00			24.46	9,732		1,273		13,475	11,236	1,283	9,732		1,273	13,436	11,214	1,283
4/26/2013	FALSE	FALSE	FALSE	3.26	8.89	6.15	53%	37%	69%		1.45	6.2	6.1	209.00	190.00	0.91		10,720	9,745			13,199	10,942	1,283	10,720	9,745	13,199	10,942	1,283	
4/27/2013	FALSE	FALSE	FALSE	3.30	8.95	5.94	56%	37%	66%		1.51	6.2	6.1									13,199	10,942	1,283			13,199	10,942	1,283	
4/28/2013	FALSE	FALSE	FALSE	3.25	9.11	6.00	54%	36%	66%		1.52	6.2	6.1									13,238	10,942	1,272			13,238	10,942	1,272	
4/29/2013	FALSE	FALSE	FALSE	3.15	9.25	6.23	51%	34%	67%		1.48	6.2	6.1	250.00				12,990				13,241	10,951	1,272	12,990		13,241	10,951	1,272	
4/30/2013	FALSE	FALSE	FALSE	3.19	9.70	6.20	51%	33%	64%		1.56	6.2	6.1	231.00	211.00	0.91		11,945	10,910			13,165	10,946	1,272	11,945	10,910	13,165	10,946	1,272	
5/1/2013	FALSE	FALSE	FALSE	3.13	9.71	6.20	50%	32%	64%		1.57	6.2	6.1									13,165	10,946	1,272			13,165	10,946	1,272	
5/2/2013	FALSE	FALSE	FALSE	3.21	9.30	6.18	52%	35%	66%		1.50	6.2	6.1	265.00			26.93	13,658		1,388		13,012	10,946	1,295	13,658		1,388	13,012	10,946	1,295
5/3/2013	FALSE	FALSE	FALSE	3.24	8.75	6.18	52%	37%	71%		1.42	6.2	6.1	272.00	215.00	0.79		14,019	11,081			13,074	10,933	1,295	14,019	11,081	13,074	10,933	1,295	
5/4/2013	FALSE	FALSE	FALSE	3.31	8.84	6.00	55%	37%	68%		1.47	6.2	6.1									13,074	10,933	1,295			13,074	10,933	1,295	
5/5/2013	FALSE	FALSE	FALSE	3.28	9.52	6.20	53%	34%	65%		1.54	6.2	6.1									13,074	10,933	1,272			13,074	10,933	1,272	
5/6/2013	FALSE	FALSE	TRUE	3.31	8.84	6.33	52%	37%	72%		1.40	6.2	6.2	221.00				11,667				12,809	10,846	1,272	11,667		12,809	10,846	1,272	
5/7/2013	FALSE	FALSE	FALSE	3.31	9.18	6.31	52%	36%	69%		1.45	6.2	6.2	262.00	177.00	0.68		13,788	9,315			12,863	10,654	1,272	13,788	9,315	12,863	10,654	1,272	
5/8/2013	FALSE	FALSE	FALSE	3.36	9.17	6.29	53%	37%	69%		1.46	6.2	6.2									12,863	10,654	1,272			12,863	10,654	1,272	
5/9/2013	FALSE	FALSE	FALSE	3.27	8.78	6.23	52%	37%	71%		1.41	6.2	6.2	189.00			23.14	9,820		1,202		12,681	10,654	1,258	9,820		1,202	12,681	10,654	1,258
5/10/2013	FALSE	FALSE	FALSE	3.27	9.55	6.17	53%	34%	65%		1.55	6.2	6.2	273.00	195.00	0.71		14,048	10,034			12,637	10,509	1,258	14,048	10,034	12,637	10,509	1,258	
5/11/2013	FALSE	FALSE	FALSE	3.23	9.52	5.98	54%	34%	63%		1.59	6.2	6.2									12,637	10,509	1,258			12,637	10,509	1,258	
5/12/2013	FALSE	FALSE	FALSE	3.31	8.63	5.93	56%	38%	69%		1.46	6.1	6.2									12,651	10,509	1,248			12,651	10,509	1,248	
5/13/2013	FALSE	FALSE	FALSE	3.25	8.69	6.22	52%	37%	72%		1.40	6.1	6.2	251.00				13,021				12,638	10,593	1,248	13,021		12,638	10,593	1,248	
5/14/2013	FALSE	FALSE	FALSE	3.36	8.96	6.24	54%	38%	70%		1.44	6.2	6.2	268.00	235.00	0.88		13,947	12,230			12,711	10,797	1,248	13,947	12,230	12,711	10,797	1,248	
5/15/2013	FALSE	FALSE	FALSE	3.24	9.75	6.23	52%	33%	64%		1.57	6.2	6.2									12,711	10,797	1,248			12,711	10,797	1,248	
5/16/2013	FALSE	FALSE	FALSE	3.35	9.30	6.26	54%	36%	67%		1.49	6.2	6.2	299.00			25.94	15,610		1,354		12,523	10,797	1,269	15,610		1,354	12,523	10,797	1,269
5/17/2013	FALSE	FALSE	FALSE	3.34	8.87	6.21	54%	38%	70%		1.43	6.2	6.2	315.00	208.00	0.66		16,314	10,773			12,792	10,828	1,269	16,314	10,773	12,792	10,828	1,269	
5/18/2013	FALSE	FALSE	FALSE	3.27	8.72	5.90	55%	38%	68%		1.48	6.1	6.1									12,792	10,828	1,304			12,792	10,828	1,304	
5/19/2013	FALSE	FALSE	FALSE	3.19	9.00	6.03	53%	35%	67%		1.49	6.1	6.1									12,862	10,828	1,304			12,862	10,828	1,304	
5/20/2013	FALSE	FALSE	FALSE	3.28	8.80	6.19	53%	37%	70%		1.42	6.1	6.2	249.00				12,855				12,840	10,828	1,304	12,855		12,840	10,828	1,304	
5/21/2013	FALSE	FALSE	FALSE	3.15	8.44	6.02	52%	37%	71%		1.40	6.1	6.1	238.00				11,949				12,790	10,828	1,304	11,949		12,790	10,828	1,304	
5/22/2013	FALSE	FALSE	FALSE	3.18	8.95	6.23	51%	36%	70%		1.44	6.2	6.1									12,790	10,828	1,304			12,790	10,828	1,304	
5/23/2013	FALSE	FALSE	FALSE	3.21	8.60	6.20	52%	37%	72%		1.39	6.2	6.1	257.00			23.95	13,289		1,238		13,030	10,828	1,291	13,289		1,238	13,030	10,828	1,291
5/24/2013	FALSE	FALSE	FALSE	3.30	8.80	6.25	53%	38%	71%		1.41	6.2	6.1	305.00	220.00	0.72		15,898	11,468			13,071	10,694	1,291	15,898	11,468	13,071	10,694	1,291	
5/25/2013	FALSE	FALSE	FALSE	3.29	8.64	6.15	53%	38%	71%		1.40	6.2	6.1									13,071	10,694	1,291			13,071	10,694	1,291	
5/26/2013	FALSE	TRUE	FALSE	3.18	9.24	5.74	55%	34%	62%		1.61	6.1	6.1									13,267	10,694	1,296			13,267	10,694	1,296	
5/27/2013	FALSE	TRUE	TRUE	3.20	9.00	6.09	53%	36%	68%		1.48	6.1	6.1									13,426	10,830	1,296			13,426	10,830	1,296	
5/28/2013	FALSE	TRUE	FALSE	3.20	8.90	5.97	54%	36%	67%		1.49	6.1	6.1	210.00	195.00	0.93		10,456	9,709			13,251	10,690	1,296	10,456	9,709	13,251	10,690	1,296	
5/29/2013	FALSE	TRUE	FALSE	3.20	8.40	6.03	53%	38%	72%		1.39	6.1	6.1									13,251	10,690	1,296			13,251	10,690	1,296	
5/30/2013	FALSE	TRUE	FALSE	3.20	8.30	5.84	55%	39%	70%		1.42	6.1	6.0	294.00			24.56	14,319		1,196		13,330	10,690	1,276	14,319		1,196	13,330	10,690	1,276
5/31/2013	TRUE	TRUE	FALSE	3.23	8.18	5.80	56%	39%	71%		1.41	6.1	6.0	275.00	235.00	0.85		13,302	11,367			13,409	10,747	1,276	13,302	11,367	13,409	10,747	1,276	
6/1/2013	TRUE	TRUE	FALSE	3.29	7.90	5.62	59%	42%	71%		1.41	6.1	5.9									13,409	10,747	1,276			13,409	10,747	1,276	
6/2/2013	TRUE	TRUE	FALSE	3.25	8.04	5.61	58%	40%	70%		1.43	6.1	5.8									13,394	10,747	1,248			13,394	10,747	1,248	
6/3/2013	TRUE	TRUE	FALSE	3.23	9.13	5.85	55%	35%	64%		1.56	6.1	5.9	114.00				5,562				12,865	10,699	1,248	5,562		12,865	10,699	1,248	
6/4/2013	TRUE	TRUE	FALSE	3.34	8.10	5.92	56%	41%	73%		1.37	6.1	5.8	296.00	225.00	0.76		14,614	11,109			12,968	10,751	1,248	14,614	11,109	12,968	10,751	1,248	
6/5/2013	TRUE	TRUE	FALSE	3.38	8.13	5.94	57%	42%	73%		1.37	6.1	5.8									12,968	10,751	1,248			12,968	10,751	1,248	
6/6/2013	TRUE	TRUE	FALSE	3.32	7.73	5.88	56%	43%	76%		1.31	6.0	5.8				20.39			1,000		13,050	10,751	1,198			1,000	13,050	10,751	1,198
6/7/2013	TRUE	TRUE	FALSE	3.30	7.70	5.76	57%	43%	75%		1.34	6.0	5.8	115.00	156.00	1.36		5,524	7,494			12,533	10,523	1,198	5,524	7,494	12,533	10,523</		

Date	Butte Break?	CSU Break?	Precip?	Min Influent Flow, mgd	Max Influent Flow, mgd	Avg Influent Flow, mgd	Min % of Avg	Min % of Max	Avg % of Max	Flow Outlier Type	Diurnal Peak Factor (DPF)	30-d Avg of Avg Flow, mgd	7-d Avg of Avg Flow, mgd	Influent TSS Conc., mg/L	Influent BOD Conc., mg/L	BOD/TSS Ratio	Influent NH3-N Conc., mg/L	Avg Inf TSS Load, ppd	Avg Inf BOD Load, ppd	Avg Inf NH3 Load, ppd	Load Outlier Type	30-d Avg of TSS Load, ppd	30-d Avg of BOD Load, ppd	30-d Avg of NH3-N Load, ppd	non-SN TSS Load, ppd	non-SN BOD Load, ppd	non-SN NH3 Load, ppd	30-d Avg of non-SN TSS Load, ppd	30-d Avg of non-SN BOD Load, ppd	30-d Avg of non-SN NH3-N Load, ppd
6/21/2013	TRUE	TRUE	FALSE	3.31	7.90	5.48	60%	42%	69%		1.44	5.8	5.5	277.00	220.00	0.79		12,660	10,055			12,587	9,990	1,106	12,660	10,055		12,587	9,990	1,106
6/22/2013	TRUE	TRUE	FALSE	3.30	7.31	5.24	63%	45%	72%		1.40	5.7	5.5									12,587	9,990	1,106				12,587	9,990	1,106
6/23/2013	TRUE	TRUE	FALSE	3.28	7.47	5.35	61%	44%	72%		1.40	5.7	5.5									12,528	9,990	1,073				12,528	9,990	1,073
6/24/2013	TRUE	TRUE	TRUE	3.30	7.97	5.75	57%	41%	72%		1.39	5.7	5.5	298.00				14,291				12,394	9,744	1,073	14,291			12,394	9,744	1,073
6/25/2013	TRUE	TRUE	TRUE	3.34	8.20	5.80	58%	41%	71%		1.41	5.7	5.6	322.00				15,576				12,639	9,744	1,073	15,090			12,602	9,744	1,073
6/26/2013	TRUE	TRUE	FALSE	3.40	8.00	5.69	60%	43%	71%		1.41	5.7	5.6				21.36			1,014		12,639	9,744	1,061			1,014	12,602	9,744	1,061
6/27/2013	TRUE	TRUE	FALSE	3.21	7.84	5.77	56%	41%	74%		1.36	5.7	5.6	347.00				16,698				12,929	9,744	1,061	16,698			12,894	9,744	1,061
6/28/2013	TRUE	TRUE	FALSE	3.18	8.17	5.51	58%	39%	67%		1.48	5.7	5.6	321.00	185.00	0.58		14,751	8,501			13,236	9,543	1,061	14,751	8,501		13,201	9,543	1,061
6/29/2013	TRUE	TRUE	FALSE	3.36	8.02	5.35	63%	42%	67%		1.50	5.6	5.6									13,236	9,543	1,061				13,201	9,543	1,061
6/30/2013	TRUE	TRUE	FALSE	3.40	8.07	5.40	63%	42%	67%		1.49	5.6	5.6									13,152	9,543	1,028				13,115	9,543	1,028
7/1/2013	TRUE	TRUE	FALSE	3.30	7.89	5.60	59%	42%	71%		1.41	5.6	5.6									13,140	9,178	1,028				13,099	9,178	1,028
7/2/2013	TRUE	TRUE	FALSE	3.29	7.96	5.66	58%	41%	71%		1.41	5.6	5.6	290.00	208.00	0.72		13,689	9,819			13,182	9,284	1,028	13,689	9,819		13,145	9,284	1,028
7/3/2013	TRUE	TRUE	FALSE	3.42	7.93	5.51	62%	43%	69%		1.44	5.6	5.6				18.44			847		13,182	9,284	992			847	13,145	9,284	992
7/4/2013	TRUE	TRUE	FALSE	3.23	7.84	5.07	64%	41%	65%		1.55	5.6	5.5									13,817	9,284	992				13,777	9,284	992
7/5/2013	TRUE	TRUE	FALSE	3.25	11.44	5.32	61%	28%	47%	AvgMax	2.15	5.6	5.4	253.00	158.00	0.62		11,225	7,010			13,535	8,601	992	11,225	7,010		13,494	8,601	992
7/6/2013	TRUE	TRUE	FALSE	3.33	7.56	5.37	62%	44%	71%		1.41	5.6	5.4									13,535	8,601	992				13,494	8,601	992
7/7/2013	TRUE	TRUE	FALSE	3.30	7.60	5.37	61%	43%	71%		1.42	5.5	5.4									13,535	8,601	989				13,494	8,601	989
7/8/2013	TRUE	TRUE	FALSE	3.30	7.60	5.34	62%	43%	70%		1.42	5.5	5.4	249.00								13,999	8,823	989	11,089			13,958	8,823	989
7/9/2013	TRUE	TRUE	FALSE	3.30	7.60	5.66	58%	43%	74%		1.34	5.5	5.4	304.00	154.00	0.51		14,350	7,269			14,026	8,564	989	14,350	7,269		13,988	8,564	989
7/10/2013	TRUE	TRUE	FALSE	3.30	10.40	5.67	58%	32%	55%	AvgMax	1.83	5.5	5.4									14,026	8,564	989				13,988	8,564	989
7/11/2013	TRUE	TRUE	FALSE	3.40	7.40	5.61	61%	46%	76%		1.32	5.5	5.4	325.00			23.91	15,206		1,119		14,110	8,564	1,015	15,206		1,119	14,075	8,564	1,015
7/12/2013	TRUE	TRUE	FALSE	3.36	7.39	5.60	60%	45%	76%		1.32	5.5	5.5	285.00				13,311				14,057	8,564	1,015	13,311			14,024	8,564	1,015
7/13/2013	TRUE	TRUE	FALSE	3.25	7.22	5.37	61%	45%	74%		1.34	5.5	5.5									13,997	8,564	1,015				13,962	8,564	1,015
7/14/2013	TRUE	TRUE	FALSE	3.28	7.31	5.33	62%	45%	73%		1.37	5.5	5.5									14,071	8,564	987				14,034	8,564	987
7/15/2013	TRUE	TRUE	FALSE	3.35	7.34	5.66	59%	46%	77%		1.30	5.5	5.5									14,197	8,531	987				14,156	8,531	987
7/16/2013	TRUE	TRUE	FALSE	3.39	7.40	5.59	61%	46%	76%		1.32	5.5	5.5	287.00				13,380				14,134	8,531	987	13,380			14,096	8,531	987
7/17/2013	TRUE	TRUE	FALSE	3.34	7.18	5.56	60%	47%	77%		1.29	5.5	5.5									14,134	8,531	987				14,096	8,531	987
7/18/2013	TRUE	TRUE	FALSE	3.35	7.35	5.75	58%	46%	78%		1.28	5.5	5.6	210.00			20.76	10,071		996		13,844	8,531	989	10,071		996	13,809	8,531	989
7/19/2013	TRUE	TRUE	FALSE	3.40	7.50	5.64	60%	45%	75%		1.33	5.5	5.6	166.00	132.00	0.80		7,808	6,209			13,441	8,144	989	7,808	6,209		13,409	8,144	989
7/20/2013	TRUE	TRUE	FALSE	3.40	7.50	5.43	63%	45%	72%		1.38	5.5	5.5									13,441	8,144	989				13,409	8,144	989
7/21/2013	TRUE	TRUE	FALSE	3.37	7.44	5.53	61%	45%	74%		1.35	5.5	5.6									13,150	8,144	994				13,116	8,144	994
7/22/2013	TRUE	TRUE	FALSE	3.35	7.61	5.78	58%	44%	76%		1.32	5.5	5.6	218.00				10,509				12,997	7,762	994	10,509			12,962	7,762	994
7/23/2013	TRUE	TRUE	FALSE	3.35	7.57	5.78	58%	44%	76%		1.31	5.5	5.6	214.00	169.00	0.79		10,316	8,147			12,818	7,826	994	9,794	8,021		12,751	7,805	994
7/24/2013	TRUE	TRUE	FALSE	3.32	7.27	5.66	59%	46%	78%		1.28	5.6	5.6									12,818	7,826	994				12,751	7,805	994
7/25/2013	TRUE	TRUE	FALSE	3.40	7.37	5.67	60%	46%	77%		1.30	5.6	5.7	237.00			16.23	11,207		767		12,612	7,826	949	11,207		767	12,545	7,805	949
7/26/2013	TRUE	TRUE	FALSE	3.34	7.94	5.46	61%	42%	69%		1.45	5.5	5.6	225.00				10,246				12,257	7,826	949	10,246			12,222	7,805	949
7/27/2013	TRUE	TRUE	FALSE	3.38	7.42	5.30	64%	46%	71%		1.40	5.5	5.6									12,257	7,826	932				12,222	7,805	932
7/28/2013	TRUE	TRUE	FALSE	3.34	8.30	5.48	61%	40%	66%		1.51	5.5	5.6									11,940	7,826	932				11,903	7,805	932
7/29/2013	TRUE	TRUE	FALSE	3.30	7.48	5.59	59%	44%	75%		1.34	5.5	5.6	229.00				10,676				11,649	7,691	932	10,676			11,612	7,666	932
7/30/2013	TRUE	TRUE	FALSE	3.28	7.01	5.55	59%	47%	79%		1.26	5.5	5.6	211.00	166.00	0.79		9,767	7,684			11,523	7,690	932	9,767	7,684		11,489	7,669	932
7/31/2013	TRUE	TRUE	FALSE	3.44	7.38	5.63	61%	47%	76%		1.31	5.5	5.5									11,523	7,690	932				11,489	7,669	932
8/1/2013	TRUE	TRUE	FALSE	3.23	7.24	5.61	58%	45%	77%		1.29	5.5	5.5				23.46			1,098		11,523	7,690	965			1,098	11,489	7,669	965
8/2/2013	TRUE	TRUE	FALSE	3.37	7.39	5.59	60%	46%	76%		1.32	5.5	5.5	295.00	161.00	0.55		13,753	7,506			11,528	7,304	965	13,753	7,506		11,493	7,283	965
8/3/2013	TRUE	TRUE	FALSE	3.27	7.53	5.31	62%	43%	71%		1.42	5.5	5.5									11,528	7,304	995				11,493	7,283	995
8/4/2013	TRUE	TRUE	FALSE	3.31	7.23	5.37	62%	46%	74%		1.35	5.5	5.5									11,528	7,304	995				11,493	7,283	995
8/5/2013	TRUE	TRUE	FALSE	3.17	7.41	5.66	56%	43%	76%		1.31	5.5	5.5	245.00				11,565				11,550	7,363	995	11,565			11,515	7,338	995
8/6/2013	TRUE	TRUE	FALSE	3.24	7.41	5.68	57%	44%	77%		1.30	5.6	5.6	230.00	175.00	0.76		10,895	8,290			11,509	7,517	995	10,895	8,290		11,477	7,497	995
8/7/2013	TRUE	TRUE	FALSE	3.19	18.58	6.86	47%	17%	37%	inMaxAvgM	2.71	5.6	5.6									11,509	7,517	995				11,477	7,497	995
8/8/2013	TRUE	TRUE	FALSE	3.31	8.16	6.17	54%	41%	76%		1.32	5.6	5.6	230.00			20.30	11,835		1,045		11,556	7,517	1,005	11,835		1,045	11,523	7,497	1,005
8/9/2013	TRUE	TRUE	FALSE	3.13	7.47	5.58	56%	42%	75%		1.34	5.6	5.6	234.00				10,890				11,340	7,567	1,005	10,890			11,307	7,542	1,005
8/10/2013	TRUE	TRUE	FALSE	3.22	7.53	5.38	60%	43%	71%		1.40	5.6	5.6									11,340	7,567	1,005						

Date	Butte Break?	CSU Break?	Precip?	Min Influent Flow, mgd	Max Influent Flow, mgd	Avg Influent Flow, mgd	Min % of Avg	Min % of Max	Avg % of Max	Flow Outlier Type	Diurnal Peak Factor (DPF)	30-d Avg of Avg Flow, mgd	7-d Avg of Avg Flow, mgd	Influent TSS Conc., mg/L	Influent BOD Conc., mg/L	BOD/TSS Ratio	Influent NH3-N Conc., mg/L	Avg Inf TSS Load, ppd	Avg Inf BOD Load, ppd	Avg Inf NH3 Load, ppd	Load Outlier Type	30-d Avg of TSS Load, ppd	30-d Avg of BOD Load, ppd	30-d Avg of NH3-N Load, ppd	non-SN TSS Load, ppd	non-SN BOD Load, ppd	non-SN NH3 Load, ppd	30-d Avg of non-SN TSS Load, ppd	30-d Avg of non-SN BOD Load, ppd	30-d Avg of non-SN NH3-N Load, ppd
8/23/2013	TRUE	TRUE	FALSE	3.42	8.34	6.06	56%	41%	73%		1.38	5.7	5.9	249.00				12,585				11,586	8,246	1,059	12,585			11,581	8,231	1,059
8/24/2013	TRUE	TRUE	FALSE	3.33	8.94	5.94	56%	37%	66%		1.51	5.7	6.0									11,586	8,246	1,059			11,581	8,231	1,059	
8/25/2013	TRUE	TRUE	FALSE	3.34	8.95	6.17	54%	37%	69%		1.45	5.7	6.1									11,610	8,246	1,132			11,604	8,231	1,132	
8/26/2013	TRUE	TRUE	FALSE	3.29	8.92	6.27	52%	37%	70%		1.42	5.7	6.1	126.00				6,589				11,381	8,246	1,132	6,589		11,375	8,231	1,132	
8/27/2013	FALSE	FALSE	FALSE	3.24	9.09	6.22	52%	36%	68%		1.46	5.8	6.1	202.00	163.00	0.81		10,479	8,456			11,328	8,281	1,132	10,479	8,456	11,323	8,268	1,132	
8/28/2013	FALSE	FALSE	FALSE	3.42	9.19	6.38	54%	37%	69%		1.44	5.8	6.2									11,328	8,281	1,132			11,323	8,268	1,132	
8/29/2013	FALSE	FALSE	FALSE	3.26	9.53	6.31	52%	34%	66%		1.51	5.8	6.2	204.00			22.99	10,736		1,210		11,332	8,281	1,147	10,736		1,210	11,326	8,268	1,147
8/30/2013	FALSE	FALSE	FALSE	3.20	9.60	6.20	52%	33%	65%		1.55	5.8	6.2	170.00				8,790				11,274	8,401	1,147	8,790		11,269	8,385	1,147	
8/31/2013	FALSE	FALSE	FALSE			5.81				gMinMaxA	0.00	5.9	6.2									11,274	8,401	1,147			11,269	8,385	1,147	
9/1/2013	FALSE	FALSE	FALSE	3.22	8.63	5.79	56%	37%	67%		1.49	5.9	6.2									11,274	8,401	1,160			11,269	8,385	1,160	
9/2/2013	FALSE	FALSE	FALSE	3.20	8.60	5.80	55%	37%	67%		1.48	5.9	6.1									11,119	8,625	1,160			11,114	8,605	1,160	
9/3/2013	FALSE	FALSE	FALSE	3.30	9.40	6.25	53%	35%	66%		1.50	5.9	6.1	195.00				10,164				11,063	8,625	1,160	10,164		11,058	8,605	1,160	
9/4/2013	FALSE	FALSE	FALSE	3.24	9.16	6.26	52%	35%	68%		1.46	5.9	6.1									11,063	8,625	1,160			11,058	8,605	1,160	
9/5/2013	FALSE	FALSE	FALSE	3.19	8.98	6.28	51%	36%	70%		1.43	5.9	6.1				26.42			1,384		11,032	8,625	1,205			11,026	8,605	1,205	
9/6/2013	FALSE	FALSE	FALSE	3.19	8.71	6.17	52%	37%	71%		1.41	6.0	6.1	236.00	176.00	0.75		12,144	9,057			11,110	8,816	1,205	12,144	9,057	11,104	8,797	1,205	
9/7/2013	FALSE	FALSE	FALSE	3.23	8.69	6.04	53%	37%	70%		1.44	6.0	6.1									11,110	8,816	1,205			11,104	8,797	1,205	
9/8/2013	FALSE	FALSE	FALSE	3.26	8.85	6.11	53%	37%	69%		1.45	6.0	6.1									11,062	8,816	1,245			11,055	8,797	1,245	
9/9/2013	FALSE	FALSE	FALSE	3.22	8.46	6.20	52%	38%	73%		1.36	6.0	6.1	222.00			25.12	11,479		1,299		11,101	8,816	1,256	11,479		1,299	11,095	8,797	1,256
9/10/2013	FALSE	FALSE	FALSE	3.16	8.31	6.21	51%	38%	75%		1.34	6.0	6.2	239.00	168.00	0.70		12,378	8,701			11,181	8,793	1,256	12,378	8,701	11,175	8,777	1,256	
9/11/2013	FALSE	FALSE	FALSE	3.41	8.85	6.83	50%	39%	77%		1.30	6.1	6.3									11,181	8,793	1,256			11,175	8,777	1,256	
9/12/2013	FALSE	FALSE	FALSE	3.30	8.83	6.59	50%	37%	75%		1.34	6.1	6.3	230.00				12,641				11,296	8,793	1,256	12,641		11,290	8,777	1,256	
9/13/2013	FALSE	FALSE	FALSE	3.23	8.86	6.33	51%	36%	71%		1.40	6.1	6.3		94.00			4,962				11,242	8,036	1,256		4,962	11,236	8,020	1,256	
9/14/2013	FALSE	FALSE	FALSE	3.33	9.12	6.08	55%	37%	67%		1.50	6.1	6.3									11,242	8,036	1,256			11,236	8,020	1,256	
9/15/2013	FALSE	FALSE	FALSE	3.29	8.70	6.11	54%	38%	70%		1.42	6.1	6.3									11,279	8,036	1,291			11,272	8,020	1,291	
9/16/2013	FALSE	FALSE	FALSE	3.33	8.87	6.34	53%	38%	71%		1.40	6.2	6.3	213.00				11,263				11,286	8,036	1,291	11,263		11,279	8,020	1,291	
9/17/2013	FALSE	FALSE	FALSE	3.45	8.90	6.23	55%	39%	70%		1.43	6.2	6.3	231.00	142.00	0.61		12,002	7,378			11,334	7,926	1,291	12,002	7,378	11,327	7,913	1,291	
9/18/2013	FALSE	FALSE	FALSE	3.37	9.15	6.33	53%	37%	69%		1.45	6.2	6.4									11,334	7,926	1,291			11,327	7,913	1,291	
9/19/2013	FALSE	FALSE	FALSE	3.35	8.84	6.25	54%	38%	71%		1.41	6.2	6.3	280.00			22.01	14,595		1,147		11,377	7,926	1,262	14,595		1,147	11,371	7,913	1,262
9/20/2013	FALSE	FALSE	FALSE	3.26	8.89	6.09	54%	37%	69%		1.46	6.2	6.2	223.00	160.00	0.72		11,326	8,126			11,312	7,780	1,262	11,326	8,126	11,312	7,780	1,262	
9/21/2013	FALSE	FALSE	TRUE	3.33	10.01	6.57	51%	33%	66%		1.52	6.2	6.3									11,312	7,780	1,262			11,312	7,780	1,262	
9/22/2013	FALSE	FALSE	TRUE	3.34	9.76	6.56	51%	34%	67%		1.49	6.2	6.3									11,226	7,780	1,260			11,226	7,780	1,260	
9/23/2013	FALSE	FALSE	FALSE	3.34	9.01	6.45	52%	37%	72%		1.40	6.2	6.4	254.00				13,663				11,304	7,780	1,260	13,663		11,304	7,780	1,260	
9/24/2013	FALSE	FALSE	TRUE	3.29	10.10	6.51	51%	33%	64%		1.55	6.3	6.4	222.00	172.00	0.77		12,053	9,338			11,354	8,003	1,260	11,821	9,255	11,338	7,991	1,260	
9/25/2013	FALSE	FALSE	TRUE	3.37	9.54	6.47	52%	35%	68%		1.47	6.3	6.4									11,354	8,003	1,260			11,338	7,991	1,260	
9/26/2013	FALSE	FALSE	FALSE	3.32	9.16	6.48	51%	36%	71%		1.41	6.3	6.4	235.00			23.21	12,700		1,254		11,761	8,003	1,259	12,700		11,745	7,991	1,259	
9/27/2013	FALSE	FALSE	FALSE	3.30	8.68	6.17	53%	38%	71%		1.41	6.3	6.4	247.00				12,710				11,910	7,927	1,259	12,710		11,894	7,913	1,259	
9/28/2013	FALSE	FALSE	FALSE	3.23	9.05	6.10	53%	36%	67%		1.48	6.3	6.4									11,910	7,927	1,259			11,894	7,913	1,259	
9/29/2013	FALSE	FALSE	FALSE	3.30	10.50	6.31	52%	31%	60%		1.66	6.3	6.4									11,994	7,927	1,271			11,977	7,913	1,271	
9/30/2013	FALSE	FALSE	FALSE	3.30	9.00	6.21	53%	37%	69%		1.45	6.3	6.3	212.00				10,980				12,150	7,927	1,271	10,980		12,133	7,913	1,271	
10/1/2013	FALSE	FALSE	FALSE	3.24	8.92	6.16	53%	36%	69%		1.45	6.3	6.3	231.00	181.00	0.78		11,867	9,299			12,131	8,123	1,271	11,867	9,299	12,116	8,111	1,271	
10/2/2013	FALSE	FALSE	FALSE	3.20	9.00	6.14	52%	36%	68%		1.47	6.3	6.3									12,131	8,123	1,271			12,116	8,111	1,271	
10/3/2013	FALSE	FALSE	FALSE	3.30	9.10	6.24	53%	36%	69%		1.46	6.3	6.2	223.00			24.06	11,605		1,252		12,098	8,123	1,267	11,605		1,252	12,084	8,111	1,267
10/4/2013	FALSE	FALSE	FALSE	3.32	8.63	6.10	54%	38%	71%		1.41	6.3	6.2	246.00	157.00	0.64		12,515	7,987			12,245	8,106	1,267	12,515	7,987	12,231	8,096	1,267	
10/5/2013	FALSE	FALSE	FALSE	3.23	9.17	6.10	53%	35%	67%		1.50	6.3	6.2									12,245	8,106	1,267			12,231	8,096	1,267	
10/6/2013	FALSE	FALSE	FALSE	3.30	8.90	6.10	54%	37%	69%		1.46	6.3	6.2									12,245	8,106	1,238			12,231	8,096	1,238	
10/7/2013	FALSE	FALSE	FALSE	3.32	8.70	6.22	53%	38%	71%		1.40	6.3	6.2	279.00				14,473				12,391	7,970	1,238	14,473		12,376	7,958	1,238	
10/8/2013	FALSE	FALSE	FALSE	3.34	8.95	6.19	54%	37%	69%		1.45	6.3	6.2	192.00	157.00	0.82		9,912	8,105			12,245	7,987	1,238	9,912	8,105	12,231	7,977	1,238	
10/9/2013	FALSE	FALSE	FALSE	3.34	9.09	6.23	54%	37%	69%		1.46	6.3	6.2									12,245	7,987	1,238			12,231	7,977	1,238	
10/10/2013	FALSE	FALSE	FALSE	3.33	8.68	6.26	53%	38%	72%		1.39	6.3	6.2	270.00			34.04	14,096		1,777		12,399	7,987	1,358	14,096		1,777	12,385	7,977	1,358
10/11/2013	FALSE	FALSE	FALSE	3.20	8.70	6.16	52%	37%	71%		1.41	6.3	6.2	209.00	177.00	0.85		10,737	9,093			12,302	8,036	1,358	10,737	9,093	12,289	8,026	1,358	
10/12/2013	FALSE	FALSE	TRUE	3.30	9.10	6.01	55%	36%	66%		1.51	6.3	6.2									12,302	8,036	1,358			12,289			

Date	Butte Break?	CSU Break?	Precip?	Min Influent Flow, mgd	Max Influent Flow, mgd	Avg Influent Flow, mgd	Min % of Avg	Min % of Max	Avg % of Max	Flow Outlier Type	Diurnal Peak Factor (DPF)	30-d Avg of Avg Flow, mgd	7-d Avg of Avg Flow, mgd	Influent TSS Conc., mg/L	Influent BOD Conc., mg/L	BOD/TSS Ratio	Influent NH3-N Conc., mg/L	Avg Inf TSS Load, ppd	Avg Inf BOD Load, ppd	Avg Inf NH3 Load, ppd	Load Outlier Type	30-d Avg of TSS Load, ppd	30-d Avg of BOD Load, ppd	30-d Avg of NH3-N Load, ppd	non-SN TSS Load, ppd	non-SN BOD Load, ppd	non-SN NH3 Load, ppd	30-d Avg of non-SN TSS Load, ppd	30-d Avg of non-SN BOD Load, ppd	30-d Avg of non-SN NH3-N Load, ppd
10/25/2013	FALSE	FALSE	FALSE	3.37	8.39	6.12	55%	40%	73%		1.37	6.2	6.1	158.00	141.00	0.89		8,064	7,197			11,783	8,764	1,489	8,064	7,197		11,762	8,754	1,489
10/26/2013	FALSE	FALSE	FALSE	3.36	8.95	5.92	57%	38%	66%		1.51	6.2	6.1									11,783	8,764	1,489				11,762	8,754	1,489
10/27/2013	FALSE	FALSE	TRUE	3.26	8.71	6.03	54%	37%	69%		1.44	6.1	6.1									11,729	8,764	1,548				11,707	8,754	1,548
10/28/2013	FALSE	FALSE	TRUE	3.28	8.59	6.22	53%	38%	72%		1.38	6.1	6.1	220.00				11,412				11,653	8,764	1,548	11,412			11,631	8,754	1,548
10/29/2013	FALSE	FALSE	FALSE	3.20	9.16	6.10	52%	35%	67%		1.50	6.1	6.1	249.00	193.00	0.78		12,668	9,819			11,709	8,881	1,548	12,668	9,819		11,688	8,872	1,548
10/30/2013	FALSE	FALSE	FALSE		8.17	5.55			68%	inAvgMinM	1.47	6.1	6.1									11,709	8,881	1,548				11,688	8,872	1,548
10/31/2013	FALSE	FALSE	FALSE	3.45	8.16	6.10	57%	42%	75%		1.34	6.1	6.1	272.00			24.89	13,838		1,266		11,868	8,881	1,492	13,838		1,266	11,847	8,872	1,492
11/1/2013	FALSE	FALSE	FALSE	3.40	8.10	6.16	55%	42%	76%		1.31	6.1	6.1	242.00	201.00	0.83		12,433	10,326			11,899	8,995	1,492	12,433	10,326		11,879	8,986	1,492
11/2/2013	FALSE	FALSE	FALSE	3.30	8.60	6.16	54%	38%	72%		1.40	6.1	6.1									11,899	8,995	1,492				11,879	8,986	1,492
11/3/2013	FALSE	FALSE	FALSE	3.29	9.08	6.15	53%	36%	68%		1.48	6.1	6.1									11,916	8,995	1,552				11,895	8,986	1,552
11/4/2013	FALSE	FALSE	FALSE	3.31	9.17	6.62	50%	36%	72%		1.39	6.1	6.2	222.00				12,257				11,901	9,121	1,552	12,257			11,879	9,111	1,552
11/5/2013	FALSE	FALSE	FALSE	6.42	12.43	9.71	66%	52%	78%		1.28	6.3	6.7	217.00	196.00	0.90		17,573	15,872			12,216	9,871	1,552	17,573	15,872		12,196	9,862	1,552
11/6/2013	FALSE	FALSE	FALSE	3.37	11.80	6.66	51%	29%	56%	AvgMax	1.77	6.3	6.8									12,216	9,871	1,552				12,196	9,862	1,552
11/7/2013	FALSE	FALSE	FALSE	3.32	8.59	6.18	54%	39%	72%		1.39	6.3	6.7	259.00			28.64	13,349		1,476		12,154	9,871	1,537	13,349		1,476	12,133	9,862	1,537
11/8/2013	FALSE	FALSE	FALSE	3.33	8.96	6.12	54%	37%	68%		1.46	6.3	6.7	277.00	195.00	0.70		14,138	9,953			12,389	10,076	1,537	14,138	9,953		12,368	10,068	1,537
11/9/2013	FALSE	FALSE	FALSE	3.26	8.89	6.03	54%	37%	68%		1.47	6.3	6.7									12,389	10,076	1,537				12,368	10,068	1,537
11/10/2013	FALSE	FALSE	FALSE	3.26	8.93	5.97	55%	37%	67%		1.50	6.3	6.7									12,288	10,076	1,476				12,266	10,068	1,476
11/11/2013	FALSE	FALSE	FALSE	3.30	9.30	6.30	52%	35%	68%		1.48	6.3	6.7									12,385	10,199	1,476				12,362	10,189	1,476
11/12/2013	FALSE	FALSE	FALSE	3.30	9.00	6.28	53%	37%	70%		1.43	6.3	6.7	223.00	215.00	0.96		11,680	11,261			12,344	10,317	1,476	11,342	11,081		12,302	10,288	1,476
11/13/2013	FALSE	FALSE	FALSE	3.31	9.06	6.40	52%	37%	71%		1.42	6.3	6.2									12,344	10,317	1,476				12,302	10,288	1,476
11/14/2013	FALSE	FALSE	FALSE	3.30	8.83	6.30	52%	37%	71%		1.40	6.3	6.2	235.00			27.28	12,347		1,433		12,369	10,317	1,468	12,347		1,433	12,327	10,288	1,468
11/15/2013	FALSE	FALSE	FALSE	3.27	8.67	6.23	52%	38%	72%		1.39	6.3	6.2	300.00	256.00	0.85		15,587	13,301			12,588	10,653	1,468	15,587	13,301		12,568	10,633	1,468
11/16/2013	FALSE	FALSE	FALSE	3.28	8.88	6.09	54%	37%	69%		1.46	6.3	6.2									12,588	10,653	1,468				12,568	10,633	1,468
11/17/2013	FALSE	FALSE	FALSE	3.25	9.51	6.23	52%	34%	66%		1.53	6.3	6.2									12,561	10,653	1,462				12,540	10,633	1,462
11/18/2013	FALSE	FALSE	FALSE	3.29	8.78	6.30	52%	37%	72%		1.39	6.3	6.3	160.00				8,407				12,317	10,764	1,462	8,407			12,296	10,742	1,462
11/19/2013	FALSE	FALSE	TRUE	3.44	9.33	6.94	50%	37%	74%		1.34	6.3	6.3	194.00	192.00	0.99		11,229	11,113			12,253	10,803	1,462	11,229	11,113		12,233	10,783	1,462
11/20/2013	FALSE	FALSE	TRUE	3.53	9.79	6.93	51%	36%	71%		1.41	6.4	6.4				20.27			1,172		12,253	10,803	1,404			1,172	12,233	10,783	1,404
11/21/2013	FALSE	FALSE	FALSE	3.55	9.49	6.79	52%	37%	72%		1.40	6.4	6.5	217.00				12,288				12,276	10,803	1,404	12,288			12,256	10,783	1,404
11/22/2013	FALSE	TRUE	FALSE	3.30	9.01	6.39	52%	37%	71%		1.41	6.4	6.5									12,250	11,105	1,404				12,229	11,083	1,404
11/23/2013	FALSE	TRUE	FALSE	3.22	9.43	5.97	54%	34%	63%		1.58	6.4	6.5									12,250	11,105	1,404				12,229	11,083	1,404
11/24/2013	FALSE	TRUE	FALSE	3.22	9.05	5.87	55%	36%	65%		1.54	6.4	6.4									12,485	11,105	1,337				12,462	11,083	1,337
11/25/2013	FALSE	TRUE	FALSE	3.24	8.82	5.98	54%	37%	68%		1.47	6.4	6.4	232.00				11,571				12,718	11,664	1,337	11,571			12,696	11,638	1,337
11/26/2013	FALSE	TRUE	FALSE	3.19	8.42	5.96	54%	38%	71%		1.41	6.4	6.4	210.00				10,438				12,576	11,664	1,337	10,438			12,555	11,638	1,337
11/27/2013	TRUE	TRUE	FALSE	3.19	8.60	5.91	54%	37%	69%		1.46	6.4	6.2				23.23			1,145		12,576	11,664	1,298			1,145	12,555	11,638	1,298
11/28/2013	TRUE	TRUE	FALSE	3.21	9.33	5.34	60%	34%	57%	AvgMax	1.75	6.4	6.1									12,653	11,664	1,298				12,631	11,638	1,298
11/29/2013	TRUE	TRUE	FALSE	3.25	8.00	5.41	60%	41%	68%		1.48	6.3	5.9									12,652	11,971	1,298				12,628	11,941	1,298
11/30/2013	TRUE	TRUE	FALSE	3.29	8.29	5.54	59%	40%	67%		1.50	6.3	5.8									12,652	11,971	1,298				12,628	11,941	1,298
12/1/2013	TRUE	TRUE	FALSE	3.26	8.79	6.00	54%	37%	68%		1.47	6.3	5.8									12,561	11,971	1,307				12,535	11,941	1,307
12/2/2013	TRUE	TRUE	FALSE	3.28	8.83	6.24	53%	37%	71%		1.42	6.3	5.9	297.00				15,456				12,794	12,300	1,307	15,456			12,768	12,264	1,307
12/3/2013	FALSE	FALSE	FALSE	3.28	8.97	6.22	53%	37%	69%		1.44	6.3	5.9	230.00	257.00	1.12		11,931	13,332			12,732	12,472	1,307	11,409	13,176		12,671	12,416	1,307
12/4/2013	FALSE	FALSE	FALSE	3.25	9.29	6.32	51%	35%	68%		1.47	6.3	5.9									12,732	12,472	1,307				12,671	12,416	1,307
12/5/2013	FALSE	FALSE	FALSE	3.26	9.17	6.17	53%	36%	67%		1.49	6.3	6.0				23.99			1,234		12,769	12,472	1,292			1,234	12,703	12,416	1,292
12/6/2013	FALSE	FALSE	TRUE	3.26	9.15	6.43	51%	36%	70%		1.42	6.2	6.0	320.00	537.00	1.68		17,160	28,797		BOD	12,737	11,792	1,292	17,160	28,797		12,671	11,725	1,292
12/7/2013	FALSE	FALSE	FALSE	3.35	9.65	6.28	53%	35%	65%		1.54	6.2	6.2									12,737	11,792	1,292				12,671	11,725	1,292
12/8/2013	FALSE	FALSE	FALSE	3.38	8.76	4.94	68%	39%	56%	AvgMax	1.77	6.2	6.2									12,686	11,792	1,246				12,615	11,725	1,246
12/9/2013	FALSE	FALSE	FALSE	3.38	9.25	6.40	53%	37%	69%		1.45	6.2	6.3	237.00				12,650				12,562	12,252	1,246	12,650			12,491	12,168	1,246
12/10/2013	FALSE	FALSE	FALSE	3.28	9.09	6.26	52%	36%	69%		1.45	6.2	6.3	239.00				12,478				12,556	12,252	1,246	12,478			12,490	12,168	1,246
12/11/2013	FALSE	FALSE	FALSE	3.22	9.39	6.29	51%	34%	67%		1.49	6.2	6.3									12,556	12,252	1,246				12,490	12,168	1,246
12/12/2013	FALSE	FALSE	FALSE	3.27	9.08	6.25	52%	36%	69%		1.45	6.2	6.3	345.00			29.48	17,983		1,537		12,943	12,252	1,304	17,983		1,537	12,882	12,168	1,304
12/13/2013	FALSE	FALSE	FALSE	3.30	9.10	6.25	53%	36%	69%		1.46	6.2	6.3	225.00	429.00	1.91		11,728	22,362</											

Date	Butte Break?	CSU Break?	Precip?	Min Influent Flow, mgd	Max Influent Flow, mgd	Avg Influent Flow, mgd	Min % of Avg	Min % of Max	Avg % of Max	Flow Outlier Type	Diurnal Peak Factor (DPF)	30-d Avg of Avg Flow, mgd	7-d Avg of Avg Flow, mgd	Influent TSS Conc., mg/L	Influent BOD Conc., mg/L	BOD/TSS Ratio	Influent NH3-N Conc., mg/L	Avg Inf TSS Load, ppd	Avg Inf BOD Load, ppd	Avg Inf NH3 Load, ppd	Load Outlier Type	30-d Avg of TSS Load, ppd	30-d Avg of BOD Load, ppd	30-d Avg of NH3-N Load, ppd	non-SN TSS Load, ppd	non-SN BOD Load, ppd	non-SN NH3 Load, ppd	30-d Avg of non-SN TSS Load, ppd	30-d Avg of non-SN BOD Load, ppd	30-d Avg of non-SN NH3-N Load, ppd
12/27/2013	TRUE	TRUE	FALSE	3.17	8.83	5.49	58%	36%	62%		1.61	6.0	5.5	280.00			23.07	12,820		1,056		13,764	9,926	1,239	12,820		1,056	13,721	9,874	1,239
12/28/2013	TRUE	TRUE	FALSE	3.19	8.31	5.35	60%	38%	64%		1.55	6.0	5.4									13,764	9,926	1,262				13,721	9,874	1,262
12/29/2013	TRUE	TRUE	FALSE	3.12	8.21	5.28	59%	38%	64%		1.55	5.9	5.4									13,764	9,926	1,262				13,721	9,874	1,262
12/30/2013	TRUE	TRUE	FALSE	3.14	8.09	5.52	57%	39%	68%		1.47	5.9	5.4	244.00				11,233				13,569	9,926	1,262	11,233			13,529	9,874	1,262
12/31/2013	TRUE	TRUE	FALSE	3.16	8.41	5.58	57%	38%	66%		1.51	5.9	5.3	317.00				14,752				13,654	9,926	1,262	14,752			13,617	9,874	1,262
1/1/2014	TRUE	TRUE	FALSE	3.18	7.98	5.23	61%	40%	66%		1.53	5.9	5.3									13,654	9,926	1,262				13,617	9,874	1,262
1/2/2014	TRUE	TRUE	FALSE	3.19	8.26	5.54	58%	39%	67%		1.49	5.9	5.4	261.00			26.37	12,059		1,218		13,411	9,926	1,254	12,059		1,218	13,374	9,874	1,254
1/3/2014	TRUE	TRUE	FALSE	3.20	8.08	5.57	57%	40%	69%		1.45	5.9	5.4	221.00	272.00	1.23		10,266	12,635			13,292	9,694	1,254	10,266	12,635		13,292	9,694	1,254
1/4/2014	TRUE	TRUE	FALSE	3.07	8.51	5.53	56%	36%	65%		1.54	5.8	5.5									13,292	9,694	1,254				13,292	9,694	1,254
1/5/2014	TRUE	TRUE	FALSE	3.00	8.47	5.56	54%	35%	66%		1.52	5.8	5.5									13,292	9,694	1,258				13,292	9,694	1,258
1/6/2014	TRUE	TRUE	FALSE	3.09	8.37	5.71	54%	37%	68%		1.47	5.8	5.5	311.00				14,810				13,124	9,694	1,258	14,810			13,124	9,694	1,258
1/7/2014	TRUE	TRUE	FALSE	3.11	8.27	5.71	54%	38%	69%		1.45	5.8	5.6	360.00	442.00	1.23		17,144	21,049		BOD	13,392	9,694	1,258	17,144	21,049		13,392	9,694	1,258
1/8/2014	TRUE	TRUE	FALSE	3.09	8.45	5.71	54%	37%	68%		1.48	5.8	5.6									13,392	9,694	1,258				13,392	9,694	1,258
1/9/2014	TRUE	TRUE	FALSE	3.09	8.31	5.66	55%	37%	68%		1.47	5.7	5.6	257.00			23.79	12,132		1,123		13,358	9,694	1,231	12,132		1,123	13,358	9,694	1,231
1/10/2014	TRUE	TRUE	FALSE	3.05	8.70	5.70	54%	35%	66%		1.53	5.7	5.6	258.00	290.00	1.12		12,265	13,786			13,344	10,717	1,231	12,265	13,786		13,344	10,717	1,231
1/11/2014	TRUE	TRUE	FALSE	3.12	8.55	5.57	56%	36%	65%		1.54	5.7	5.6									13,344	10,717	1,231				13,344	10,717	1,231
1/12/2014	TRUE	TRUE	FALSE	3.02	8.80	5.65	53%	34%	64%		1.56	5.7	5.7									13,012	10,717	1,155				13,012	10,717	1,155
1/13/2014	TRUE	TRUE	FALSE	3.04	8.32	5.71	53%	37%	69%		1.46	5.7	5.7									13,111	10,717	1,155				13,111	10,717	1,155
1/14/2014	TRUE	TRUE	FALSE	3.14	8.48	5.68	55%	37%	67%		1.49	5.7	5.7	281.00	319.00	1.14		13,311	15,111			13,125	11,596	1,155	13,311	15,111		13,125	11,596	1,155
1/15/2014	TRUE	TRUE	FALSE	3.11	8.37	5.69	55%	37%	68%		1.47	5.6	5.7									13,125	11,596	1,155				13,125	11,596	1,155
1/16/2014	TRUE	TRUE	FALSE	3.05	8.48	5.73	53%	36%	68%		1.48	5.6	5.7	276.00			21.35	13,190		1,020		13,036	11,596	1,128	13,190		1,020	13,036	11,596	1,128
1/17/2014	TRUE	TRUE	FALSE	3.12	8.19	5.71	55%	38%	70%		1.43	5.6	5.7	284.00	218.00	0.77		13,524	10,381			13,129	11,394	1,128	13,524	10,381		13,129	11,394	1,128
1/18/2014	TRUE	TRUE	FALSE	3.09	9.37	5.71	54%	33%	61%		1.64	5.6	5.7									13,129	11,394	1,128				13,129	11,394	1,128
1/19/2014	TRUE	TRUE	FALSE	3.05	9.48	5.60	54%	32%	59%		1.69	5.6	5.7									13,162	11,204	1,128				13,162	11,204	1,128
1/20/2014	TRUE	TRUE	FALSE	3.07	9.41	5.93	52%	33%	63%		1.59	5.6	5.7									13,126	11,204	1,104				13,126	11,204	1,104
1/21/2014	TRUE	FALSE	FALSE	3.09	9.01	5.98	52%	34%	66%		1.51	5.6	5.8	355.00	172.00	0.48		17,705	8,578			13,478	10,766	1,104	17,291	8,441		13,446	10,744	1,104
1/22/2014	TRUE	FALSE	FALSE	3.14	9.01	6.00	52%	35%	67%		1.50	5.6	5.8									13,478	10,766	1,104				13,446	10,744	1,104
1/23/2014	TRUE	FALSE	FALSE	3.13	8.86	5.99	52%	35%	68%		1.48	5.6	5.8	293.00			24.36	14,637		1,217		13,561	10,766	1,127	14,637		1,217	13,531	10,744	1,127
1/24/2014	TRUE	FALSE	FALSE	3.10	8.70	5.95	52%	36%	68%		1.46	5.6	5.9	261.00	222.00	0.85		12,952	11,016			13,520	10,802	1,127	12,952	11,016		13,492	10,783	1,127
1/25/2014	TRUE	FALSE	FALSE	3.10	9.30	5.79	54%	33%	62%		1.61	5.7	5.9									13,520	10,802	1,127				13,492	10,783	1,127
1/26/2014	TRUE	FALSE	FALSE	3.07	9.39	5.90	52%	33%	63%		1.59	5.7	5.9									13,520	11,918	1,127				13,492	11,895	1,127
1/27/2014	TRUE	FALSE	FALSE	3.14	8.98	5.98	53%	35%	67%		1.50	5.7	5.9	248.00				12,369				13,490	11,918	1,145	12,369			13,462	11,895	1,145
1/28/2014	FALSE	FALSE	FALSE	3.18	8.84	5.91	54%	36%	67%		1.50	5.7	5.9	242.00	221.00	0.91		11,928	10,893			13,392	11,772	1,145	11,928	10,893		13,366	11,752	1,145
1/29/2014	FALSE	FALSE	TRUE	3.21	8.89	6.05	53%	36%	68%		1.47	5.7	5.9									13,392	11,772	1,145				13,366	11,752	1,145
1/30/2014	FALSE	FALSE	TRUE	3.20	9.00	6.11	52%	36%	68%		1.47	5.7	6.0	259.00			25.21	13,198		1,285		13,515	11,772	1,173	13,198		1,285	13,489	11,752	1,173
1/31/2014	FALSE	FALSE	FALSE	3.20	8.95	6.14	52%	36%	69%		1.46	5.8	6.0	222.00	229.00	1.03		11,368	11,727			13,304	11,766	1,173	11,368	11,727		13,278	11,749	1,173
2/1/2014	FALSE	FALSE	FALSE	3.09	9.74	6.03	51%	32%	62%		1.62	5.8	6.0									13,304	11,766	1,173				13,278	11,749	1,173
2/2/2014	FALSE	FALSE	FALSE	3.11	10.28	5.94	52%	30%	58%	AvgMax	1.73	5.8	6.0									13,387	11,766	1,161				13,359	11,749	1,161
2/3/2014	FALSE	FALSE	FALSE	3.15	9.13	6.06	52%	35%	66%		1.51	5.8	6.0	300.00				15,162				13,713	11,642	1,161	15,162			13,685	11,622	1,161
2/4/2014	FALSE	FALSE	FALSE	3.15	9.10	6.04	52%	35%	66%		1.51	5.8	6.0	232.00				11,687				13,586	11,642	1,161	11,687			13,560	11,622	1,161
2/5/2014	FALSE	FALSE	TRUE	3.20	9.55	6.13	52%	34%	64%		1.56	5.9	6.1									13,586	11,642	1,161				13,560	11,622	1,161
2/6/2014	FALSE	FALSE	TRUE	3.27	9.22	6.19	53%	35%	67%		1.49	5.9	6.1	247.00			25.30	12,751		1,306		13,458	11,642	1,190	12,751		1,306	13,432	11,622	1,190
2/7/2014	FALSE	FALSE	TRUE	3.24	9.37	6.46	50%	35%	69%		1.45	5.9	6.2	274.00	229.00	0.84		14,762	12,338			13,309	11,729	1,190	14,762	12,338		13,283	11,712	1,190
2/8/2014	FALSE	FALSE	TRUE	3.67	12.57	7.85	47%	29%	62%		1.60	6.0	6.4									13,309	11,729	1,190				13,283	11,712	1,190
2/9/2014	FALSE	FALSE	TRUE	4.32	12.48	8.38	52%	35%	67%		1.49	6.1	6.7									13,387	11,729	1,207				13,360	11,712	1,207
2/10/2014	FALSE	FALSE	TRUE	6.61	14.02	9.86	67%	47%	70%		1.42	6.2	7.1	194.00				15,953				13,633	11,435	1,207	15,953			13,606	11,415	1,207
2/11/2014	FALSE	FALSE	FALSE	3.68	11.17	7.65	48%	33%	68%		1.46	6.3	7.3	168.00				10,719				13,451	11,435	1,207	10,719			13,425	11,415	1,207
2/12/2014	FALSE	FALSE	FALSE	3.49	10.39	7.05	50%	34%	68%		1.47	6.3	7.4	225.00				13,229				13,438	11,435	1,207	13,229			13,414	11,415	1,207
2/13/2014	FALSE	FALSE	FALSE	3.39	10.05	6.71	51%	34%	67%		1.50	6.3	7.5				22.82			1,277		13,438	11,435	1,221			1,277	13,414	11,415	1,221
2/14/2014	FALSE	FALSE	FALSE	3.36	10.00	6.76	50%	34%	68%		1.48	6.4	7.6	301																

Date	Butte Break?	CSU Break?	Precip?	Min Influent Flow, mgd	Max Influent Flow, mgd	Avg Influent Flow, mgd	Min % of Avg	Min % of Max	Avg % of Max	Flow Outlier Type	Diurnal Peak Factor (DPF)	30-d Avg of Avg Flow, mgd	7-d Avg of Avg Flow, mgd	Influent TSS Conc., mg/L	Influent BOD Conc., mg/L	BOD/TSS Ratio	Influent NH3-N Conc., mg/L	Avg Inf TSS Load, ppd	Avg Inf BOD Load, ppd	Avg Inf NH3 Load, ppd	Load Outlier Type	30-d Avg of TSS Load, ppd	30-d Avg of BOD Load, ppd	30-d Avg of NH3-N Load, ppd	non-SN TSS Load, ppd	non-SN BOD Load, ppd	non-SN NH3 Load, ppd	30-d Avg of non-SN TSS Load, ppd	30-d Avg of non-SN BOD Load, ppd	30-d Avg of non-SN NH3-N Load, ppd
2/28/2014	FALSE	FALSE	TRUE	3.45	10.18	7.12	48%	34%	70%		1.43	6.6	6.3	232.00	243.00	1.05		13,776	14,430			13,669	12,892	1,213	13,776	14,430		13,669	12,892	1,213
3/1/2014	FALSE	FALSE	TRUE	3.84	11.34	7.57	51%	34%	67%		1.50	6.7	6.5									13,669	12,892	1,213				13,669	12,892	1,213
3/2/2014	FALSE	FALSE	TRUE	3.57	10.86	6.98	51%	33%	64%		1.56	6.7	6.6									13,701	12,892	1,198				13,701	12,892	1,198
3/3/2014	FALSE	FALSE	TRUE	3.46	12.84	7.73	45%	27%	60%		1.66	6.7	6.8	216.00				13,925				13,871	13,126	1,198	13,925			13,871	13,126	1,198
3/4/2014	FALSE	FALSE	TRUE	5.69	12.66	9.29	61%	45%	73%		1.36	6.8	7.2									13,871	13,126	1,198				13,871	13,126	1,198
3/5/2014	FALSE	FALSE	TRUE	4.10	11.72	8.28	50%	35%	71%		1.42	6.9	7.5	192.00	139.00	0.72		13,259	9,599			13,833	12,538	1,198	13,259	9,599		13,833	12,538	1,198
3/6/2014	FALSE	FALSE	TRUE	4.81	12.20	8.68	55%	39%	71%		1.41	7.0	7.8									13,744	12,538	1,198				13,744	12,538	1,198
3/7/2014	FALSE	FALSE	FALSE	3.90	11.11	7.81	50%	35%	70%		1.42	7.0	7.9	195.00			16.03	12,701		1,044		13,812	12,538	1,173	12,701		1,044	13,812	12,538	1,173
3/8/2014	FALSE	FALSE	FALSE	3.71	10.93	7.24	51%	34%	66%		1.51	7.1	7.9									13,812	12,538	1,173				13,812	12,538	1,173
3/9/2014	FALSE	FALSE	TRUE	3.51	10.81	7.06	50%	32%	65%		1.53	7.1	7.9									13,888	12,538	1,146				13,888	12,538	1,146
3/10/2014	FALSE	FALSE	TRUE	4.06	12.74	8.94	45%	32%	70%		1.43	7.2	8.1	209.00				15,583				13,946	12,578	1,146	15,583			13,946	12,578	1,146
3/11/2014	FALSE	FALSE	FALSE	4.09	11.83	8.06	51%	35%	68%		1.47	7.2	8.2	237.00	165.00	0.70		15,931	11,091			14,079	12,330	1,146	15,931	11,091		14,079	12,330	1,146
3/12/2014	FALSE	FALSE	FALSE	3.74	10.72	7.52	50%	35%	70%		1.43	7.2	7.9									14,079	12,330	1,146				14,079	12,330	1,146
3/13/2014	FALSE	FALSE	FALSE	3.53	10.43	7.18	49%	34%	69%		1.45	7.1	7.8	192.00			15.97	11,497		956		13,782	12,330	1,114	11,497		956	13,782	12,330	1,114
3/14/2014	TRUE	TRUE	FALSE	3.57	9.77	6.82	52%	37%	70%		1.43	7.0	7.6	220.00	177.00	0.80		12,513	10,068			13,901	12,007	1,114	12,513	10,068		13,901	12,007	1,114
3/15/2014	TRUE	TRUE	FALSE	3.38	9.48	6.21	54%	36%	66%		1.53	7.0	7.4									13,949	12,007	1,114				13,949	12,007	1,114
3/16/2014	TRUE	TRUE	FALSE	3.36	9.09	5.93	57%	37%	65%		1.53	7.0	7.2									13,949	12,007	1,082				13,949	12,007	1,082
3/17/2014	TRUE	TRUE	FALSE		9.19	6.04			66%	inAvgMinM	1.52	7.0	7.2	245.00			19.91	12,342		1,003		13,619	11,837	1,069	12,342		1,003	13,619	11,837	1,069
3/18/2014	TRUE	TRUE	FALSE	3.29	8.55	5.86	56%	38%	69%		1.46	7.0	6.8	222.00	196.00	0.88		10,850	9,579			13,434	11,515	1,069	10,850	9,579		13,434	11,515	1,069
3/19/2014	TRUE	TRUE	FALSE	3.34	8.33	5.78	58%	40%	69%		1.44	7.0	6.5									13,434	11,515	1,069				13,434	11,515	1,069
3/20/2014	TRUE	TRUE	FALSE	3.32	8.23	5.74	58%	40%	70%		1.43	6.9	6.2	243.00				11,633				13,322	11,515	1,069	11,633			13,322	11,515	1,069
3/21/2014	TRUE	TRUE	FALSE	3.30	8.56	5.75	57%	39%	67%		1.49	6.9	6.0	237.00				11,365				13,274	11,519	1,069	11,365			13,274	11,519	1,069
3/22/2014	TRUE	TRUE	FALSE	3.24	8.76	5.64	57%	37%	64%		1.55	6.9	5.8									13,274	11,519	1,069				13,274	11,519	1,069
3/23/2014	TRUE	TRUE	FALSE	3.20	9.02	5.81	55%	35%	64%		1.55	6.9	5.8									13,274	11,519	1,025				13,274	11,519	1,025
3/24/2014	TRUE	TRUE	FALSE	3.28	9.31	6.13	54%	35%	66%		1.52	6.9	5.8	204.00				10,429				12,936	11,519	1,025	10,429			12,936	11,519	1,025
3/25/2014	TRUE	FALSE	TRUE	3.28	9.41	6.40	51%	35%	68%		1.47	6.9	5.9	262.00	217.00	0.83	24.81	13,985	11,583	1,324		12,997	11,528	1,085	13,985	11,583	1,324	12,997	11,528	1,085
3/26/2014	FALSE	FALSE	TRUE	3.37	9.70	6.75	50%	35%	70%		1.44	6.9	6.0									12,997	11,528	1,085				12,997	11,528	1,085
3/27/2014	FALSE	FALSE	FALSE	3.46	9.89	6.84	51%	35%	69%		1.45	6.9	6.1	257.00				14,661				13,179	11,528	1,085	14,661			13,179	11,528	1,085
3/28/2014	FALSE	FALSE	TRUE	3.43	9.58	6.72	51%	36%	70%		1.43	7.0	6.3	223.00	205.00	0.92		12,498	11,489			13,085	11,120	1,085	12,498	11,489		13,085	11,120	1,085
3/29/2014	FALSE	FALSE	TRUE	3.44	11.29	7.18	48%	30%	64%		1.57	7.0	6.4									13,085	11,120	1,085				13,085	11,120	1,085
3/30/2014	FALSE	FALSE	TRUE	4.11	11.73	7.94	52%	35%	68%		1.48	7.0	6.7									12,934	11,120	1,082				12,934	11,120	1,082
3/31/2014	FALSE	FALSE	TRUE	3.67	10.53	7.68	48%	35%	73%		1.37	7.1	7.0	223.00				14,283				12,966	10,568	1,082	14,283			12,966	10,568	1,082
4/1/2014	FALSE	FALSE	TRUE	3.58	10.62	7.62	47%	34%	72%		1.39	7.1	7.1	209.00	182.00	0.87		13,282	11,566			12,985	10,711	1,082	13,282	11,566		12,985	10,711	1,082
4/2/2014	FALSE	FALSE	FALSE	3.64	11.04	7.37	49%	33%	67%		1.50	7.1	7.3									12,985	10,711	1,082				12,985	10,711	1,082
4/3/2014	FALSE	FALSE	FALSE	3.51	10.38	7.19	49%	34%	69%		1.44	7.0	7.3	92.00			23.33	5,517		1,399		12,490	10,711	1,145	5,517		1,399	12,490	10,711	1,145
4/4/2014	FALSE	FALSE	TRUE	3.54	9.89	6.94	51%	36%	70%		1.43	7.0	7.3	219.00	176.00	0.80		12,676	10,187			12,500	10,645	1,145	12,676	10,187		12,500	10,645	1,145
4/5/2014	FALSE	FALSE	FALSE	3.42	10.25	6.64	52%	33%	65%		1.54	6.9	7.3									12,456	10,795	1,145				12,456	10,795	1,145
4/6/2014	FALSE	FALSE	FALSE	3.37	10.21	6.55	51%	33%	64%		1.56	6.8	7.2									12,456	10,795	1,145				12,456	10,795	1,145
4/7/2014	FALSE	FALSE	FALSE	3.39	9.59	6.47	52%	35%	67%		1.48	6.8	7.1	214.00				11,547				12,388	10,795	1,171	11,547			12,388	10,795	1,171
4/8/2014	FALSE	FALSE	FALSE	3.38	9.48	6.35	53%	36%	67%		1.49	6.8	6.9	191.00	193.00	1.01		10,115	10,221			12,262	10,723	1,171	10,115	10,221		12,262	10,723	1,171
4/9/2014	FALSE	FALSE	FALSE	3.36	9.63	6.30	53%	35%	65%		1.53	6.7	6.7									12,262	10,723	1,171				12,262	10,723	1,171
4/10/2014	FALSE	FALSE	FALSE	3.40	9.40	6.33	54%	36%	67%		1.48	6.7	6.6	196.00			21.81	10,347		1,151		11,971	10,723	1,167	10,347		1,151	11,971	10,723	1,167
4/11/2014	FALSE	FALSE	FALSE	3.38	9.26	6.31	54%	37%	68%		1.47	6.6	6.5	189.00	188.00	0.99		9,946	9,894			11,638	10,573	1,167	9,946	9,894		11,638	10,573	1,167
4/12/2014	FALSE	FALSE	FALSE	3.34	9.40	6.12	55%	36%	65%		1.54	6.6	6.4									11,638	10,573	1,167				11,638	10,573	1,167
4/13/2014	FALSE	FALSE	FALSE	3.30	9.59	6.09	54%	34%	64%		1.57	6.5	6.3									11,646	10,573	1,219				11,646	10,573	1,219
4/14/2014	FALSE	FALSE	FALSE	3.35	9.27	6.18	54%	36%	67%		1.50	6.5	6.3	202.00				10,411				11,523	10,645	1,219	10,411			11,523	10,645	1,219
4/15/2014	FALSE	FALSE	FALSE	3.30	9.13	6.07	54%	36%	66%		1.50	6.5	6.2	232.00				11,745				11,535	10,645	1,219	11,745			11,535	10,645	1,219
4/16/2014	FALSE	FALSE	FALSE	3.31	9.22	6.13	54%	36%	66%		1.50	6.5	6.2									11,535	10,645	1,219				11,535	10,645	1,219
4/17/2014	FALSE	FALSE	FALSE	3.33	9.16	6.21	54%	36%	68%		1.48	6.5	6.2	325.00			22.43	16,832		1,162		11,785	10,645	1,259	16,832		1,162	11,785	10,645	1,259
4/18/2014	FALSE	FALSE	FALSE	3.28	9.52	6.12	54%	34%																						

Date	Butte Break?	CSU Break?	Precip?	Min Influent Flow, mgd	Max Influent Flow, mgd	Avg Influent Flow, mgd	Min % of Avg	Min % of Max	Avg % of Max	Flow Outlier Type	Diurnal Peak Factor (DPF)	30-d Avg of Avg Flow, mgd	7-d Avg of Avg Flow, mgd	Influent TSS Conc., mg/L	Influent BOD Conc., mg/L	BOD/TSS Ratio	Influent NH3-N Conc., mg/L	Avg Inf TSS Load, ppd	Avg Inf BOD Load, ppd	Avg Inf NH3 Load, ppd	Load Outlier Type	30-d Avg of TSS Load, ppd	30-d Avg of BOD Load, ppd	30-d Avg of NH3-N Load, ppd	non-SN TSS Load, ppd	non-SN BOD Load, ppd	non-SN NH3 Load, ppd	30-d Avg of non-SN TSS Load, ppd	30-d Avg of non-SN BOD Load, ppd	30-d Avg of non-SN NH3-N Load, ppd
5/2/2014	FALSE	FALSE	FALSE	3.30	9.22	6.04	55%	36%	66%		1.53	6.3	6.2	269.00	213.00	0.79		13,550	10,730			12,208	11,084	1,240	13,550	10,730		12,208	11,084	1,240
5/3/2014	FALSE	FALSE	FALSE	3.29	9.27	6.03	55%	35%	65%		1.54	6.2	6.1									12,208	11,084	1,240				12,208	11,084	1,240
5/4/2014	FALSE	FALSE	FALSE	3.38	9.63	6.15	55%	35%	64%		1.57	6.2	6.1									12,602	11,084	1,200				12,602	11,084	1,200
5/5/2014	FALSE	FALSE	FALSE	3.58	9.32	6.36	56%	38%	68%		1.47	6.2	6.1	170.00				9,017				12,387	11,212	1,200	9,017			12,387	11,212	1,200
5/6/2014	FALSE	FALSE	FALSE	3.61	9.28	6.21	58%	39%	67%		1.49	6.2	6.1	570.00	270.00	0.47		29,521	13,984		TSS	12,387	11,559	1,200	29,521	13,984		12,387	11,559	1,200
5/7/2014	FALSE	FALSE	FALSE	3.50	9.38	6.21	56%	37%	66%		1.51	6.2	6.1									12,387	11,559	1,200				12,387	11,559	1,200
5/8/2014	FALSE	FALSE	FALSE	3.57	9.36	6.31	57%	38%	67%		1.48	6.2	6.2	236.00			24.95	12,420		1,313		12,438	11,559	1,223	12,420		1,313	12,438	11,559	1,223
5/9/2014	FALSE	FALSE	FALSE	3.56	9.07	6.25	57%	39%	69%		1.45	6.2	6.2	272.00	212.00	0.78		14,178	11,051			12,677	11,662	1,223	14,178	11,051		12,677	11,662	1,223
5/10/2014	FALSE	FALSE	FALSE	3.52	9.51	6.04	58%	37%	64%		1.57	6.1	6.2									12,677	11,662	1,223				12,677	11,662	1,223
5/11/2014	FALSE	FALSE	FALSE	3.48	9.47	5.94	59%	37%	63%		1.59	6.1	6.2									12,823	11,662	1,241				12,823	11,662	1,241
5/12/2014	FALSE	FALSE	FALSE	3.60	9.19	6.14	59%	39%	67%		1.50	6.1	6.2	257.00				13,160				13,024	11,915	1,241	13,160			13,024	11,915	1,241
5/13/2014	FALSE	FALSE	FALSE	3.51	8.91	6.12	57%	39%	69%		1.46	6.1	6.2	301.00	176.00	0.58		15,363	8,983			13,161	11,549	1,241	15,363	8,983		13,161	11,549	1,241
5/14/2014	FALSE	FALSE	FALSE	3.56	9.14	6.17	58%	39%	68%		1.48	6.1	6.1									13,161	11,549	1,241				13,161	11,549	1,241
5/15/2014	FALSE	FALSE	FALSE	3.59	9.39	6.18	58%	38%	66%		1.52	6.1	6.1	296.00	184.00	0.62		15,256	9,484			13,446	11,319	1,241	15,256	9,484		13,446	11,319	1,241
5/16/2014	FALSE	FALSE	FALSE	3.64	9.17	6.22	59%	40%	68%		1.47	6.1	6.1	246.00			25.16	12,761		1,305		13,506	11,319	1,254	12,761		1,305	13,506	11,319	1,254
5/17/2014	FALSE	FALSE	FALSE	3.61	8.82	6.01	60%	41%	68%		1.47	6.1	6.1									13,506	11,319	1,254				13,506	11,319	1,254
5/18/2014	FALSE	TRUE	FALSE	3.49	8.88	5.93	59%	39%	67%		1.50	6.1	6.1									13,298	11,319	1,277				13,298	11,319	1,277
5/19/2014	FALSE	TRUE	TRUE	3.55	8.52	6.04	59%	42%	71%		1.41	6.1	6.1	195.00				9,823				12,949	11,126	1,277	9,823			12,949	11,126	1,277
5/20/2014	FALSE	TRUE	TRUE	3.56	8.46	5.97	60%	42%	71%		1.42	6.1	6.1	152.00				7,568				12,632	11,126	1,277	7,568			12,632	11,126	1,277
5/21/2014	FALSE	TRUE	FALSE	3.59	8.57	6.04	59%	42%	70%		1.42	6.1	6.1									12,632	11,126	1,277				12,632	11,126	1,277
5/22/2014	FALSE	TRUE	FALSE	3.57	8.41	5.98	60%	42%	71%		1.41	6.1	6.0	150.00			21.22	7,481		1,058		12,299	11,126	1,233	7,481		1,058	12,299	11,126	1,233
5/23/2014	FALSE	TRUE	FALSE	3.63	8.59	5.98	61%	42%	70%		1.44	6.1	6.0	262.00	185.00	0.71		13,067	9,227			12,245	10,748	1,237	13,067	9,227		12,245	10,748	1,237
5/24/2014	FALSE	TRUE	FALSE	3.63	8.45	5.55	65%	43%	66%		1.52	6.1	5.9									12,245	10,748	1,237				12,245	10,748	1,237
5/25/2014	FALSE	TRUE	FALSE	3.35	8.10	5.31	63%	41%	66%		1.53	6.1	5.9									12,199	10,748	1,237				12,199	10,748	1,237
5/26/2014	FALSE	TRUE	FALSE	3.60	8.58	5.60	64%	42%	65%		1.53	6.1	5.8									12,116	10,614	1,237				12,116	10,614	1,237
5/27/2014	FALSE	TRUE	FALSE	3.51	7.93	5.75	61%	44%	73%		1.38	6.0	5.8	255.00				12,229				12,123	10,614	1,237	12,229			12,123	10,614	1,237
5/28/2014	FALSE	TRUE	FALSE	3.54	8.34	5.84	61%	42%	70%		1.43	6.0	5.8									12,123	10,614	1,237				12,123	10,614	1,237
5/29/2014	FALSE	TRUE	FALSE	3.52	8.03	5.75	61%	44%	72%		1.40	6.0	5.7	342.00			23.53	16,401		1,128		12,393	10,614	1,216	16,401		1,128	12,393	10,614	1,216
5/30/2014	TRUE	TRUE	FALSE	3.56	8.39	5.77	62%	42%	69%		1.45	6.0	5.7	255.00	215.00	0.84		12,271	10,346			12,441	10,543	1,216	12,271	10,346		12,441	10,543	1,216
5/31/2014	TRUE	TRUE	FALSE	3.53	8.45	5.53	64%	42%	65%		1.53	6.0	5.6									12,441	10,543	1,216				12,441	10,543	1,216
6/1/2014	TRUE	TRUE	FALSE	3.48	8.51	5.53	63%	41%	65%		1.54	6.0	5.6									12,303	10,543	1,201				12,303	10,543	1,201
6/2/2014	TRUE	TRUE	FALSE	3.53	8.17	5.80	61%	43%	71%		1.41	6.0	5.7	194.00				9,384				12,025	10,512	1,201	9,384			12,025	10,512	1,201
6/3/2014	TRUE	TRUE	FALSE	3.48	8.10	5.75	61%	43%	71%		1.41	5.9	5.7	175.00	171.00	0.98		8,392	8,200			11,798	10,182	1,201	8,392	8,200		11,798	10,182	1,201
6/4/2014	TRUE	TRUE	FALSE	3.52	8.15	5.77	61%	43%	71%		1.41	5.9	5.7									11,798	10,182	1,201				11,798	10,182	1,201
6/5/2014	TRUE	TRUE	FALSE	3.54	7.87	5.80	61%	45%	74%		1.36	5.9	5.7	195.00			24.66	9,433		1,193		11,824	10,182	1,200	9,433		1,193	11,824	10,182	1,200
6/6/2014	TRUE	TRUE	FALSE	3.50	7.70	5.63	62%	45%	73%		1.37	5.9	5.7	296.00	177.00	0.60		13,898	8,311			11,946	9,372	1,200	13,898	8,311		11,946	9,372	1,200
6/7/2014	TRUE	TRUE	FALSE	3.45	7.95	5.41	64%	43%	68%		1.47	5.9	5.7									11,946	9,372	1,200				11,946	9,372	1,200
6/8/2014	TRUE	TRUE	FALSE	3.41	7.60	5.33	64%	45%	70%		1.43	5.8	5.6									11,917	9,372	1,171				11,917	9,372	1,171
6/9/2014	TRUE	TRUE	FALSE	3.47	7.57	5.57	62%	46%	74%		1.36	5.8	5.6	248.00				11,521				11,750	9,092	1,171	11,521			11,750	9,092	1,171
6/10/2014	TRUE	TRUE	FALSE	3.43	7.61	5.57	62%	45%	73%		1.37	5.8	5.6	225.00	215.00	0.96		10,452	9,988			11,674	9,220	1,171	10,452	9,988		11,674	9,220	1,171
6/11/2014	TRUE	TRUE	FALSE	3.45	7.76	5.70	61%	44%	73%		1.36	5.8	5.6									11,674	9,220	1,171				11,674	9,220	1,171
6/12/2014	TRUE	TRUE	FALSE	3.46	7.73	5.68	61%	45%	73%		1.36	5.8	5.6	206.00			21.98	9,758		1,041		11,474	9,220	1,145	9,758		1,041	11,474	9,220	1,145
6/13/2014	TRUE	TRUE	FALSE	3.47	13.73	5.62	62%	25%	41%	AvgMax	2.44	5.8	5.6	265.00	174.00	0.66		12,421	8,156			11,301	9,102	1,145	12,421	8,156		11,301	9,102	1,145
6/14/2014	TRUE	TRUE	FALSE	3.47	8.21	5.40	64%	42%	66%		1.52	5.7	5.5									11,301	9,102	1,145				11,301	9,102	1,145
6/15/2014	TRUE	TRUE	FALSE	3.46	7.94	5.32	65%	44%	67%		1.49	5.7	5.5									11,054	9,038	1,145				11,054	9,038	1,145
6/16/2014	TRUE	TRUE	FALSE	3.46	7.97	5.65	61%	43%	71%		1.41	5.7	5.6	246.00				11,592				10,981	9,038	1,105	11,592			10,981	9,038	1,105
6/17/2014	TRUE	TRUE	FALSE	3.50	7.91	5.60	63%	44%	71%		1.41	5.7	5.6	243.00	192.00	0.79		11,349	8,967			11,002	9,028	1,105	11,349	8,967		11,002	9,028	1,105
6/18/2014	TRUE	TRUE	FALSE	3.53	7.85	5.68	62%	45%	72%		1.38	5.7	5.6									11,002	9,028	1,105				11,002	9,028	1,105
6/19/2014	TRUE	TRUE	FALSE	3.58	8.07	5.69	63%	44%	71%		1.42	5.7	5.6	228.00			23.24	10,820		1,103		11,061	9,028	1,105	10,820		1,103	11,061	9,028	1,105
6/20/2014	TRUE	TRUE	FALSE	3.54	7.69	5.56	64%	46%	72%		1.38	5.7																		

Date	Butte Break?	CSU Break?	Precip?	Min Influent Flow, mgd	Max Influent Flow, mgd	Avg Influent Flow, mgd	Min % of Avg	Min % of Max	Avg % of Max	Flow Outlier Type	Diurnal Peak Factor (DPF)	30-d Avg of Avg Flow, mgd	7-d Avg of Avg Flow, mgd	Influent TSS Conc., mg/L	Influent BOD Conc., mg/L	BOD/TSS Ratio	Influent NH3-N Conc., mg/L	Avg Inf TSS Load, ppd	Avg Inf BOD Load, ppd	Avg Inf NH3 Load, ppd	Load Outlier Type	30-d Avg of TSS Load, ppd	30-d Avg of BOD Load, ppd	30-d Avg of NH3-N Load, ppd	non-SN TSS Load, ppd	non-SN BOD Load, ppd	non-SN NH3 Load, ppd	30-d Avg of non-SN TSS Load, ppd	30-d Avg of non-SN BOD Load, ppd	30-d Avg of non-SN NH3-N Load, ppd
7/4/2014	TRUE	TRUE	FALSE	3.57	5.12	5.12	70%	70%	100%	igMinMaxA	1.00	5.6	5.6									10,984	8,933	1,134				10,981	8,930	1,134
7/5/2014	TRUE	TRUE	FALSE	3.52	7.07	4.95	71%	50%	70%	MinAvg	1.43	5.6	5.6									10,984	8,933	1,134				10,981	8,930	1,134
7/6/2014	TRUE	TRUE	FALSE	3.47	7.37	5.22	66%	47%	71%		1.41	5.5	5.5									11,088	8,933	1,120				11,085	8,930	1,120
7/7/2014	TRUE	TRUE	FALSE	3.54	7.85	5.62	63%	45%	72%		1.40	5.5	5.6	160.00				7,499				10,661	9,022	1,120	7,499			10,658	9,018	1,120
7/8/2014	TRUE	TRUE	FALSE	3.51	7.71	5.56	63%	46%	72%		1.39	5.5	5.6									10,661	9,022	1,120				10,658	9,018	1,120
7/9/2014	TRUE	TRUE	FALSE	3.57	7.84	5.73	62%	46%	73%		1.37	5.6	5.6	107.00				5,113				10,315	9,022	1,120	5,113			10,311	9,018	1,120
7/10/2014	TRUE	TRUE	FALSE	3.63	7.86	5.78	63%	46%	74%		1.36	5.6	5.6	313.00			20.97	15,088		1,011		10,538	9,022	1,098	15,088		1,011	10,534	9,018	1,098
7/11/2014	TRUE	TRUE	TRUE	3.55	8.08	5.68	63%	44%	70%		1.42	5.6	5.6	238.00	178.00	0.75		11,274	8,432			10,589	8,799	1,098	11,274	8,432		10,586	8,796	1,098
7/12/2014	TRUE	TRUE	FALSE	3.51	7.97	5.39	65%	44%	68%		1.48	5.6	5.6									10,589	8,799	1,098				10,586	8,796	1,098
7/13/2014	TRUE	TRUE	FALSE	3.44	7.85	5.36	64%	44%	68%		1.46	5.6	5.5									10,644	8,799	1,112				10,641	8,796	1,112
7/14/2014	TRUE	TRUE	FALSE	3.58	7.67	5.57	64%	47%	73%		1.38	5.6	5.6	207.00				9,616				10,457	8,907	1,112	9,616			10,454	8,902	1,112
7/15/2014	TRUE	TRUE	FALSE	3.54	7.71	5.61	63%	46%	73%		1.37	5.6	5.6	243.00	192.00	0.79		11,369	8,983			10,514	8,918	1,112	11,369	8,983		10,511	8,914	1,112
7/16/2014	TRUE	TRUE	FALSE	3.57	7.78	5.64	63%	46%	72%		1.38	5.6	5.6									10,514	8,918	1,112				10,511	8,914	1,112
7/17/2014	TRUE	TRUE	FALSE	3.52	7.90	5.65	62%	45%	72%		1.40	5.6	5.6	244.00			34.91	11,498		1,645		10,508	8,918	1,219	11,498		1,645	10,505	8,914	1,219
7/18/2014	TRUE	TRUE	FALSE	3.49	7.79	5.59	62%	45%	72%		1.39	5.6	5.6	271.00	283.00	1.04		12,634	13,194			10,589	9,521	1,219	12,634	13,194		10,586	9,518	1,219
7/19/2014	TRUE	TRUE	FALSE	3.48	7.90	5.38	65%	44%	68%		1.47	5.6	5.5									10,589	9,521	1,219				10,586	9,518	1,219
7/20/2014	TRUE	TRUE	FALSE	3.44	7.93	5.43	63%	43%	68%		1.46	5.6	5.5									10,573	9,521	1,248				10,570	9,518	1,248
7/21/2014	TRUE	TRUE	FALSE	3.58	8.11	5.71	63%	44%	70%		1.42	5.6	5.6	238.00				11,334				10,726	9,864	1,248	11,334			10,723	9,860	1,248
7/22/2014	TRUE	TRUE	TRUE	3.51	7.82	5.63	62%	45%	72%		1.39	5.6	5.6	271.00	184.00	0.68		12,725	8,640			10,851	9,689	1,248	12,725	8,640		10,848	9,686	1,248
7/23/2014	TRUE	TRUE	FALSE	3.48	7.71	5.65	62%	45%	73%		1.36	5.6	5.6									10,851	9,689	1,248				10,848	9,686	1,248
7/24/2014	TRUE	TRUE	FALSE	3.55	7.71	5.56	64%	46%	72%		1.39	5.6	5.6	222.00			23.24	10,294		1,078		10,869	9,689	1,214	10,294		1,078	10,866	9,686	1,214
7/25/2014	TRUE	TRUE	FALSE	3.56	7.75	5.48	65%	46%	71%		1.41	5.6	5.6	311.00				14,214				11,074	9,849	1,214	14,214			11,074	9,849	1,214
7/26/2014	TRUE	TRUE	FALSE	3.52	7.93	5.27	67%	44%	66%		1.50	5.6	5.5									11,074	9,849	1,214				11,074	9,849	1,214
7/27/2014	TRUE	TRUE	FALSE	3.42	7.80	5.34	64%	44%	68%		1.46	5.5	5.5									10,972	9,849	1,228				10,972	9,849	1,228
7/28/2014	TRUE	TRUE	FALSE	3.58	7.86	5.62	64%	46%	72%		1.40	5.5	5.5	285.00				13,358				11,121	9,537	1,228	13,358			11,121	9,537	1,228
7/29/2014	TRUE	TRUE	FALSE	3.52	7.60	5.52	64%	46%	73%		1.38	5.5	5.5	233.00	172.00	0.74		10,727	7,918			11,098	9,267	1,228	10,727	7,918		11,098	9,267	1,228
7/30/2014	TRUE	TRUE	FALSE	3.51	7.76	5.57	63%	45%	72%		1.39	5.6	5.5									11,098	9,267	1,228				11,098	9,267	1,228
7/31/2014	TRUE	TRUE	FALSE	3.56	7.85	5.65	63%	45%	72%		1.39	5.6	5.5	242.00			24.09	11,403		1,135		11,168	9,267	1,210	11,403		1,135	11,168	9,267	1,210
8/1/2014	TRUE	TRUE	FALSE	3.61	7.78	5.62	64%	46%	72%		1.38	5.6	5.5	267.00	176.00	0.66		12,515	8,249			11,243	9,122	1,210	12,515	8,249		11,243	9,122	1,210
8/2/2014	TRUE	TRUE	FALSE	3.53	7.50	5.31	66%	47%	71%		1.41	5.5	5.5									11,314	9,236	1,210				11,314	9,236	1,210
8/3/2014	TRUE	TRUE	FALSE	3.49	7.78	5.40	65%	45%	69%		1.44	5.5	5.5									11,291	9,236	1,217				11,291	9,236	1,217
8/4/2014	TRUE	TRUE	TRUE	2.04	7.53	5.45	37%	27%	72%	MinAvg	1.38	5.5	5.5	220.00				10,000				11,215	9,236	1,217	10,000			11,215	9,236	1,217
8/5/2014	TRUE	TRUE	TRUE	3.17	8.33	5.77	55%	38%	69%		1.44	5.5	5.5	231.00	163.00	0.71		11,116	7,844			11,210	9,037	1,217	11,116	7,844		11,210	9,037	1,217
8/6/2014	TRUE	TRUE	FALSE	3.20	8.33	5.80	55%	38%	70%		1.44	5.6	5.6									11,210	9,037	1,217				11,210	9,037	1,217
8/7/2014	TRUE	TRUE	FALSE	3.27	8.39	5.71	57%	39%	68%		1.47	5.6	5.6	236.00			20.92	11,239		996		11,418	9,037	1,173	11,239		996	11,418	9,037	1,173
8/8/2014	TRUE	TRUE	FALSE	3.19	7.75	5.43	59%	41%	70%		1.43	5.6	5.6	230.00	177.00	0.77		10,416	8,016			11,365	8,909	1,173	10,416	8,016		11,365	8,909	1,173
8/9/2014	TRUE	TRUE	FALSE	3.17	7.84	5.19	61%	40%	66%		1.51	5.5	5.5									11,712	8,909	1,173				11,712	8,909	1,173
8/10/2014	TRUE	TRUE	FALSE	3.10	7.92	5.26	59%	39%	66%		1.51	5.5	5.5									11,514	8,909	1,214				11,514	8,909	1,214
8/11/2014	TRUE	TRUE	FALSE	3.16	8.29	5.54	57%	38%	67%		1.50	5.5	5.5	221.00				10,211				11,451	8,978	1,214	10,211			11,451	8,978	1,214
8/12/2014	TRUE	TRUE	FALSE	3.17	7.77	5.52	57%	41%	71%		1.41	5.5	5.5	170.00	150.00	0.88		7,826	6,906			11,250	8,719	1,214	7,826	6,906		11,250	8,719	1,214
8/13/2014	TRUE	TRUE	FALSE	3.16	7.67	5.54	57%	41%	72%		1.38	5.5	5.5									11,250	8,719	1,214				11,250	8,719	1,214
8/14/2014	TRUE	TRUE	FALSE	3.18	7.80	5.58	57%	41%	72%		1.40	5.5	5.5	191.00			23.24	8,889		1,082		11,209	8,719	1,187	8,889		1,082	11,209	8,719	1,187
8/15/2014	TRUE	TRUE	FALSE	3.24	7.81	5.54	58%	41%	71%		1.41	5.5	5.5	291.00				13,445				11,325	8,681	1,187	13,445			11,325	8,681	1,187
8/16/2014	TRUE	TRUE	FALSE	3.20	8.07	5.34	60%	40%	66%		1.51	5.5	5.4									11,325	8,681	1,187				11,325	8,681	1,187
8/17/2014	TRUE	TRUE	FALSE	3.14	8.44	5.46	58%	37%	65%		1.55	5.5	5.5									11,314	8,681	1,073				11,314	8,681	1,073
8/18/2014	TRUE	TRUE	FALSE	3.22	8.18	5.72	56%	39%	70%		1.43	5.5	5.5	238.00				11,354				11,239	7,929	1,073	11,354			11,239	7,929	1,073
8/19/2014	TRUE	TRUE	FALSE	3.18	8.27	5.55	57%	38%	67%		1.49	5.5	5.5	207.00	161.00	0.78		9,581	7,452			11,147	7,861	1,073	9,581	7,452		11,147	7,861	1,073
8/20/2014	TRUE	TRUE	FALSE	3.14	8.41	5.83	54%	37%	69%		1.44	5.5	5.6									11,147	7,861	1,073				11,147	7,861	1,073
8/21/2014	TRUE	TRUE	FALSE	3.14	8.49	5.90	53%	37%	69%		1.44	5.5	5.6	332.00			26.11	16,336		1,285		11,425	7,861	1,115	16,336		1,285	11,425	7,861	1,115
8/22/2014	TRUE	TRUE	FALSE	3.16	8.33	5.87	54%	38%	70%		1.42	5.6	5.7	281.00	226.00	0.80		13,757	11,064			11,482	8,207	1,115	13,757					

Date	Butte Break?	CSU Break?	Precip?	Min Influent Flow, mgd	Max Influent Flow, mgd	Avg Influent Flow, mgd	Min % of Avg	Min % of Max	Avg % of Max	Flow Outlier Type	Diurnal Peak Factor (DPF)	30-d Avg of Avg Flow, mgd	7-d Avg of Avg Flow, mgd	Influent TSS Conc., mg/L	Influent BOD Conc., mg/L	BOD/TSS Ratio	Influent NH3-N Conc., mg/L	Avg Inf TSS Load, ppd	Avg Inf BOD Load, ppd	Avg Inf NH3 Load, ppd	Load Outlier Type	30-d Avg of TSS Load, ppd	30-d Avg of BOD Load, ppd	30-d Avg of NH3-N Load, ppd	non-SN TSS Load, ppd	non-SN BOD Load, ppd	non-SN NH3 Load, ppd	30-d Avg of non-SN TSS Load, ppd	30-d Avg of non-SN BOD Load, ppd	30-d Avg of non-SN NH3-N Load, ppd
9/5/2014	FALSE	FALSE	FALSE	3.19	8.88	6.03	53%	36%	68%		1.47	5.7	5.9	246.00	190.00	0.77		12,371	9,555			11,597	8,828	1,141	12,371	9,555		11,597	8,828	1,141
9/6/2014	FALSE	FALSE	FALSE	3.23	9.06	5.79	56%	36%	64%		1.56	5.7	5.8									11,597	8,828	1,141				11,597	8,828	1,141
9/7/2014	FALSE	FALSE	FALSE	3.13	9.09	5.87	53%	34%	65%		1.55	5.7	5.9									11,619	8,828	1,177				11,619	8,828	1,177
9/8/2014	FALSE	FALSE	FALSE	3.20	8.90	6.01	53%	36%	68%		1.48	5.8	5.9	213.00			23.98	10,676		1,202		11,635	8,963	1,182	10,676		1,202	11,635	8,963	1,182
9/9/2014	FALSE	FALSE	FALSE	3.20	9.00	5.98	54%	36%	66%		1.51	5.8	5.9	247.00				12,319				11,675	8,963	1,182	12,319			11,675	8,963	1,182
9/10/2014	FALSE	FALSE	FALSE	3.19	9.06	6.00	53%	35%	66%		1.51	5.8	6.0									11,675	8,963	1,182				11,675	8,963	1,182
9/11/2014	FALSE	FALSE	FALSE	3.23	9.10	6.00	54%	35%	66%		1.52	5.8	6.0									11,767	8,963	1,182				11,767	8,963	1,182
9/12/2014	FALSE	FALSE	FALSE	3.24	8.56	5.92	55%	38%	69%		1.45	5.8	6.0	264.00	170.00	0.64		13,034	8,393			12,092	9,211	1,182	13,034	8,393		12,092	9,211	1,182
9/13/2014	FALSE	FALSE	FALSE	3.14	8.82	5.65	56%	36%	64%		1.56	5.8	5.9									12,092	9,211	1,182				12,092	9,211	1,182
9/14/2014	FALSE	FALSE	FALSE	3.13	8.97	5.76	54%	35%	64%		1.56	5.8	5.9									12,306	9,211	1,207				12,306	9,211	1,207
9/15/2014	FALSE	FALSE	FALSE	3.16	8.69	5.89	54%	36%	68%		1.48	5.8	5.9	249.00				12,232				12,225	9,211	1,207	12,232			12,225	9,211	1,207
9/16/2014	FALSE	FALSE	FALSE	3.11	8.85	5.85	53%	35%	66%		1.51	5.9	5.9	238.00	169.00	0.71		11,612	8,245			12,187	9,073	1,207	11,386	8,201		12,173	9,067	1,207
9/17/2014	FALSE	FALSE	FALSE	3.14	8.85	5.96	53%	35%	67%		1.48	5.9	5.9									12,187	9,073	1,207				12,173	9,067	1,207
9/18/2014	FALSE	FALSE	FALSE	3.18	8.88	5.99	53%	36%	67%		1.48	5.9	5.9	265.00			24.65	13,238		1,231		12,305	9,073	1,212	13,238		1,231	12,290	9,067	1,212
9/19/2014	FALSE	FALSE	FALSE	3.21	8.72	5.98	54%	37%	69%		1.46	5.9	5.9	231.00	164.00	0.71		11,521	8,179			12,426	9,177	1,212	11,521	8,179		12,412	9,170	1,212
9/20/2014	FALSE	FALSE	FALSE	3.22	8.96	5.79	56%	36%	65%		1.55	5.9	5.9									12,426	9,177	1,212				12,412	9,170	1,212
9/21/2014	FALSE	FALSE	FALSE	3.19	9.05	5.82	55%	35%	64%		1.55	5.9	5.9									12,165	9,177	1,194				12,150	9,170	1,194
9/22/2014	FALSE	FALSE	FALSE	3.17	8.99	6.03	53%	35%	67%		1.49	5.9	5.9	236.00				11,868				12,039	8,862	1,194	11,868			12,024	8,855	1,194
9/23/2014	FALSE	FALSE	FALSE	3.17	8.81	5.92	54%	36%	67%		1.49	5.9	5.9	226.00	186.00	0.82		11,158	9,183			11,984	8,908	1,194	11,158	9,183		11,970	8,902	1,194
9/24/2014	FALSE	FALSE	FALSE	3.17	9.03	6.02	53%	35%	67%		1.50	5.9	5.9									11,984	8,908	1,194				11,970	8,902	1,194
9/25/2014	FALSE	FALSE	TRUE	3.23	9.41	6.32	51%	34%	67%		1.49	5.9	6.0	285.00			27.91	15,022		1,471		12,343	8,908	1,249	15,022		1,471	12,329	8,902	1,249
9/26/2014	FALSE	FALSE	FALSE	3.18	8.84	6.13	52%	36%	69%		1.44	5.9	6.0	227.00	178.00	0.78		11,605	9,100			12,232	8,821	1,249	11,605	9,100		12,217	8,815	1,249
9/27/2014	FALSE	FALSE	FALSE	3.18	8.97	5.86	54%	35%	65%		1.53	5.9	6.0									12,232	8,821	1,249				12,217	8,815	1,249
9/28/2014	FALSE	FALSE	FALSE	3.10	9.27	5.88	53%	33%	63%		1.58	5.9	6.0									12,302	8,821	1,268				12,287	8,815	1,268
9/29/2014	FALSE	FALSE	FALSE	3.15	9.28	5.97	53%	34%	64%		1.55	5.9	6.0	212.00				10,555				12,183	8,776	1,268	10,555			12,168	8,769	1,268
9/30/2014	FALSE	FALSE	FALSE	3.17	8.83	6.02	53%	36%	68%		1.47	5.9	6.0	236.00	193.00	0.82		11,849	9,690			12,162	8,907	1,268	11,849	9,690		12,148	8,900	1,268
10/1/2014	FALSE	FALSE	FALSE	3.12	9.05	5.89	53%	34%	65%		1.54	5.9	6.0									12,162	8,907	1,268				12,148	8,900	1,268
10/2/2014	FALSE	FALSE	FALSE		11.94	5.87			49%	gMinMaxA	2.03	5.9	6.0	271.00			24.95	13,267		1,221		12,227	8,907	1,259	13,267		1,221	12,214	8,900	1,259
10/3/2014	FALSE	FALSE	FALSE		11.70	5.85			50%	gMinMaxA	2.00	5.9	6.0	231.00	216.00	0.94		11,270	10,538			12,147	9,111	1,259	11,270	10,538		12,133	9,105	1,259
10/4/2014	FALSE	FALSE	FALSE	3.02	13.81	5.77	52%	22%	42%	inMaxAvgM	2.39	5.9	5.9									12,147	9,111	1,259				12,133	9,105	1,259
10/5/2014	FALSE	FALSE	FALSE	3.12	9.56	5.81	54%	33%	61%		1.65	5.9	5.9									12,100	9,111	1,281				12,086	9,105	1,281
10/6/2014	FALSE	FALSE	FALSE	3.15	9.48	5.91	53%	33%	62%		1.60	5.9	5.9	244.00				12,027				12,078	9,047	1,281	12,027			12,064	9,041	1,281
10/7/2014	FALSE	FALSE	FALSE	3.17	9.27	6.00	53%	34%	65%		1.55	5.9	5.9	242.00	189.00	0.78		12,110	9,458			12,080	9,098	1,281	12,110	9,458		12,067	9,093	1,281
10/8/2014	FALSE	FALSE	FALSE	3.13	9.57	5.95	53%	33%	62%		1.61	5.9	5.9									12,080	9,098	1,281				12,067	9,093	1,281
10/9/2014	FALSE	FALSE	FALSE	3.14	9.28	5.97	53%	34%	64%		1.55	5.9	5.9	224.00			24.75	11,153		1,232		12,108	9,098	1,289	10,923		1,232	12,081	9,093	1,289
10/10/2014	FALSE	FALSE	FALSE	3.12	9.04	5.97	52%	35%	66%		1.51	5.9	5.9	238.00	181.00	0.76		11,850	9,012			12,081	9,089	1,289	11,850	9,012		12,054	9,084	1,289
10/11/2014	FALSE	FALSE	FALSE	3.20	9.42	5.78	55%	34%	61%		1.63	5.9	5.9									12,081	9,089	1,289				12,054	9,084	1,289
10/12/2014	FALSE	FALSE	FALSE	3.10	9.03	5.70	54%	34%	63%		1.58	5.9	5.9									12,081	9,089	1,289				12,054	9,084	1,289
10/13/2014	FALSE	FALSE	FALSE	3.04	9.14	5.91	51%	33%	65%		1.55	5.9	5.9	236.00				11,632				11,998	9,176	1,289	11,632			11,971	9,170	1,289
10/14/2014	FALSE	FALSE	FALSE	3.12	9.48	6.09	51%	33%	64%		1.56	5.9	5.9									11,998	9,176	1,289				11,971	9,170	1,289
10/15/2014	FALSE	FALSE	TRUE	3.19	9.32	6.08	52%	34%	65%		1.53	5.9	5.9	264.00	177.00	0.67		13,387	8,975			12,075	9,153	1,289	13,387	8,975		12,050	9,149	1,289
10/16/2014	FALSE	FALSE	FALSE	3.17	9.25	6.12	52%	34%	66%		1.51	6.0	6.0				26.38			1,346		12,066	9,153	1,301			1,346	12,039	9,149	1,301
10/17/2014	FALSE	FALSE	FALSE	3.16	9.25	6.17	51%	34%	67%		1.50	6.0	6.0	256.00				13,173				12,158	9,267	1,301	13,173			12,144	9,267	1,301
10/18/2014	FALSE	FALSE	FALSE	3.17	9.63	5.90	54%	33%	61%		1.63	6.0	6.0									12,158	9,267	1,301				12,144	9,267	1,301
10/19/2014	FALSE	FALSE	FALSE	3.27	9.64	5.93	55%	34%	62%		1.63	6.0	6.0									12,090	9,267	1,318				12,076	9,267	1,318
10/20/2014	FALSE	FALSE	TRUE	3.10	9.44	6.09	51%	33%	65%		1.55	6.0	6.0	238.00				12,088				12,126	9,422	1,318	12,088			12,112	9,422	1,318
10/21/2014	FALSE	FALSE	FALSE	3.11	13.51	6.01	52%	23%	44%	inMaxAvgM	2.25	6.0	6.1									12,126	9,422	1,318				12,112	9,422	1,318
10/22/2014	FALSE	FALSE	FALSE	3.12	9.34	6.05	52%	33%	65%		1.54	6.0	6.0	237.00				11,958				12,116	9,422	1,318	11,958			12,103	9,422	1,318
10/23/2014	FALSE	FALSE	FALSE	3.14	9.26	6.01	52%	34%	65%		1.54	6.0	6.0				28.56			1,432		12,132	9,422	1,341			1,432	12,117	9,422	1,341
10/24/2014	FALSE	FALSE	FALSE	3.11	8.89	5.90	53%	35%	66%		1.51	6.0	6.0	276.00				13,581				12,283	9,462	1,341	13,581		</			

Date	Butte Break?	CSU Break?	Precip?	Min Influent Flow, mgd	Max Influent Flow, mgd	Avg Influent Flow, mgd	Min % of Avg	Min % of Max	Avg % of Max	Flow Outlier Type	Diurnal Peak Factor (DPF)	30-d Avg of Avg Flow, mgd	7-d Avg of Avg Flow, mgd	Influent TSS Conc., mg/L	Influent BOD Conc., mg/L	BOD/TSS Ratio	Influent NH3-N Conc., mg/L	Avg Inf TSS Load, ppd	Avg Inf BOD Load, ppd	Avg Inf NH3 Load, ppd	Load Outlier Type	30-d Avg of TSS Load, ppd	30-d Avg of BOD Load, ppd	30-d Avg of NH3-N Load, ppd	non-SN TSS Load, ppd	non-SN BOD Load, ppd	non-SN NH3 Load, ppd	30-d Avg of non-SN TSS Load, ppd	30-d Avg of non-SN BOD Load, ppd	30-d Avg of non-SN NH3-N Load, ppd
11/7/2014	FALSE	FALSE	FALSE	3.39	8.40	6.05	56%	40%	72%		1.39	6.0	6.2	284.00				14,330				12,369	9,571	1,384	14,330			12,353	9,571	1,384
11/8/2014	FALSE	FALSE	FALSE	3.28	8.34	5.81	56%	39%	70%		1.44	6.0	6.1									12,369	9,571	1,384			12,353	9,571	1,384	
11/9/2014	FALSE	FALSE	FALSE	3.31	8.44	5.86	56%	39%	69%		1.44	6.0	6.1									12,463	9,571	1,422			12,463	9,571	1,422	
11/10/2014	FALSE	FALSE	FALSE	3.29	8.05	5.89	56%	41%	73%		1.37	6.0	6.0	284.00				13,951				12,624	9,757	1,422	13,951		12,624	9,757	1,422	
11/11/2014	FALSE	FALSE	FALSE	3.35	8.46	6.04	55%	40%	71%		1.40	6.0	6.0									12,624	9,757	1,422			12,624	9,757	1,422	
11/12/2014	FALSE	FALSE	FALSE	3.37	8.16	5.94	57%	41%	73%		1.37	6.0	6.0									12,624	9,757	1,422			12,624	9,757	1,422	
11/13/2014	FALSE	FALSE	TRUE	3.37	8.14	6.08	55%	41%	75%		1.34	6.0	6.0				26.86			1,362		12,707	9,757	1,410			1,362	12,707	9,757	1,410
11/14/2014	FALSE	FALSE	FALSE	3.37	8.17	6.02	56%	41%	74%		1.36	6.0	6.0	271.00	234.00	0.86		13,606	11,748			12,776	10,255	1,410	13,606	11,748	12,776	10,255	1,410	
11/15/2014	FALSE	FALSE	FALSE	3.34	8.39	5.87	57%	40%	70%		1.43	6.0	5.9									12,725	10,681	1,410			12,725	10,681	1,410	
11/16/2014	FALSE	FALSE	FALSE	3.22	8.61	5.92	54%	37%	69%		1.45	6.0	6.0									12,725	10,681	1,426			12,725	10,681	1,426	
11/17/2014	FALSE	FALSE	FALSE	3.28	8.19	6.02	54%	40%	74%		1.36	6.0	6.0	215.00				10,794				12,527	10,681	1,426	10,794		12,527	10,681	1,426	
11/18/2014	FALSE	FALSE	FALSE	3.31	8.20	6.08	54%	40%	74%		1.35	6.0	6.0									12,527	10,681	1,426			12,527	10,681	1,426	
11/19/2014	FALSE	FALSE	TRUE	3.25	8.43	6.26	52%	39%	74%		1.35	6.0	6.0	200.00	208.00	1.04		10,442	10,859			12,367	10,726	1,426	10,442	10,859	12,367	10,726	1,426	
11/20/2014	FALSE	FALSE	TRUE	3.46	8.68	6.36	54%	40%	73%		1.36	6.0	6.1				26.17			1,388		12,390	10,726	1,418			1,388	12,390	10,726	1,418
11/21/2014	FALSE	TRUE	TRUE	3.50	8.38	6.29	56%	42%	75%		1.33	6.0	6.1	268.00				14,059				12,518	10,726	1,418	13,832		12,501	10,726	1,418	
11/22/2014	FALSE	TRUE	TRUE	3.72	8.86	6.15	60%	42%	69%		1.44	6.0	6.1									12,565	10,726	1,418			12,565	10,726	1,418	
11/23/2014	FALSE	TRUE	TRUE	3.33	8.50	5.86	57%	39%	69%		1.45	6.0	6.1									12,565	10,726	1,415			12,565	10,726	1,415	
11/24/2014	FALSE	TRUE	FALSE	3.42	7.68	5.81	59%	45%	76%		1.32	6.0	6.1									12,472	10,726	1,415			12,472	10,726	1,415	
11/25/2014	FALSE	TRUE	FALSE	3.40	8.72	5.73	59%	39%	66%		1.52	6.0	6.1				26.85			1,283		12,472	10,726	1,388			1,283	12,472	10,726	1,388
11/26/2014	TRUE	TRUE	FALSE	3.25	9.01	5.80	56%	36%	64%		1.55	6.0	6.0	217.00	220.00	1.01		10,497	10,642			12,308	10,709	1,388	10,497	10,642	12,289	10,709	1,388	
11/27/2014	TRUE	TRUE	FALSE	2.68	9.35	5.31	50%	29%	57%	AvgMax	1.76	6.0	6.0									12,463	10,709	1,388			12,442	10,709	1,388	
11/28/2014	TRUE	TRUE	TRUE	3.18	8.67	5.32	60%	37%	61%		1.63	6.0	5.9									12,463	10,709	1,388			12,442	10,709	1,388	
11/29/2014	TRUE	TRUE	TRUE	3.26	12.89	5.79	56%	25%	45%	AvgMax	2.23	6.0	5.8									12,366	10,797	1,388			12,344	10,797	1,388	
11/30/2014	TRUE	TRUE	TRUE	3.36	10.24	6.36	53%	33%	62%		1.61	6.0	5.8									12,366	10,797	1,372			12,344	10,797	1,372	
12/1/2014	TRUE	TRUE	TRUE	3.53	10.17	6.88	51%	35%	68%		1.48	6.0	6.0	162.00				9,295				11,924	10,797	1,372	9,295		11,902	10,797	1,372	
12/2/2014	FALSE	FALSE	TRUE	1.48	18.82	6.62	22%	8%	35%	gMinMaxA	2.84	6.0	6.0									11,924	10,797	1,372			11,902	10,797	1,372	
12/3/2014	FALSE	FALSE	TRUE	3.84	15.91	8.24	47%	24%	52%	inMaxAvgM	1.93	6.0	6.1									11,924	10,797	1,372			11,902	10,797	1,372	
12/4/2014	FALSE	FALSE	TRUE	3.88	11.74	7.51	52%	33%	64%		1.56	6.1	6.5				13.50			846		12,077	10,797	1,267			846	12,052	10,797	1,267
12/5/2014	FALSE	FALSE	TRUE		11.32	7.48			66%	inAvgMinM	1.51	6.1	6.5	232.00	212.00	0.91		14,473	13,225			12,317	11,282	1,267	14,473	13,225	12,294	11,282	1,267	
12/6/2014	FALSE	FALSE	TRUE	4.58	12.92	8.14	56%	35%	63%		1.59	6.2	7.2									12,383	11,619	1,267			12,358	11,619	1,267	
12/7/2014	FALSE	FALSE	TRUE	3.74	12.05	7.19	52%	31%	60%		1.68	6.2	7.2									12,383	11,619	1,220			12,358	11,619	1,220	
12/8/2014	FALSE	FALSE	FALSE	3.59	11.06	6.85	52%	32%	62%		1.61	6.2	7.3	250.00				14,282				12,378	11,619	1,220	14,282		12,352	11,619	1,220	
12/9/2014	FALSE	FALSE	FALSE	3.52	10.55	6.68	53%	33%	63%		1.58	6.3	7.3									12,378	11,619	1,220			12,352	11,619	1,220	
12/10/2014	FALSE	FALSE	TRUE	3.43	11.19	6.72	51%	31%	60%		1.67	6.3	7.2	364.00	243.00	0.67		20,400	13,619			13,180	12,019	1,220	20,208	13,569	13,138	12,009	1,220	
12/11/2014	FALSE	FALSE	TRUE	5.23	18.88	12.92	40%	28%	68%	MinAvg	1.46	6.3	7.2				22.00			2,371	NH3	13,094	12,019	1,220			2,371	13,048	12,009	1,220
12/12/2014	FALSE	FALSE	TRUE	8.93	18.82	11.76	76%	47%	62%	MinAvg	1.60	6.3	7.1									13,094	12,019	1,220			13,048	12,009	1,220	
12/13/2014	FALSE	FALSE	FALSE	5.13	14.10	9.04	57%	36%	64%		1.56	6.5	7.4									13,094	12,019	1,220			13,048	12,009	1,220	
12/14/2014	FALSE	FALSE	FALSE	4.07	12.94	7.98	51%	31%	62%		1.62	6.5	7.4									13,094	12,019	1,172			13,048	12,009	1,172	
12/15/2014	FALSE	FALSE	TRUE	3.69	15.68	8.89	42%	24%	57%	gMinMaxA	1.76	6.6	7.5	169.00				12,530				12,975	12,086	1,172	12,530		12,928	12,074	1,172	
12/16/2014	FALSE	FALSE	TRUE	6.59	17.37	10.94	60%	38%	63%		1.59	6.8	8.3				8.94			816		12,975	12,086	1,083			12,928	12,074	1,083	
12/17/2014	FALSE	FALSE	TRUE	6.56	15.39	10.94	60%	43%	71%		1.41	7.0	9.1	112.00	116.00	1.04		10,219	10,584			12,699	11,786	1,083	10,219	10,584	12,657	11,776	1,083	
12/18/2014	FALSE	FALSE	TRUE	5.36	15.03	9.93	54%	36%	66%		1.51	7.2	9.8									12,911	11,786	1,083			12,864	11,776	1,083	
12/19/2014	TRUE	TRUE	TRUE	5.33	15.72	10.46	51%	34%	67%		1.50	7.4	9.9	168.00				14,656				13,085	11,786	1,083	14,656		13,043	11,776	1,083	
12/20/2014	TRUE	TRUE	TRUE	5.01	15.22	9.15	55%	33%	60%		1.66	7.5	9.8									13,379	12,017	1,083			13,332	12,005	1,083	
12/21/2014	TRUE	TRUE	FALSE	4.08	12.75	7.99	51%	32%	63%		1.60	7.6	9.6									13,379	12,017	981			13,332	12,005	981	
12/22/2014	TRUE	TRUE	FALSE	4.00	13.62	7.55	53%	29%	55%	AvgMax	1.80	7.6	9.9	134.00				8,438				12,754	12,017	981	8,438		12,733	12,005	981	
12/23/2014	TRUE	TRUE	FALSE	3.80	11.46	7.20	53%	33%	63%		1.59	7.7	9.5				12.71			763		12,754	12,017	927			763	12,733	12,005	927
12/24/2014	TRUE	TRUE	FALSE	3.63	10.97	6.80	53%	33%	62%		1.61	7.7	8.9									12,754	12,017	927			12,733	12,005	927	
12/25/2014	TRUE	TRUE	FALSE	3.39	9.07	5.75	59%	37%	63%		1.58	7.7	8.2									12,754	12,017	927			12,733	12,005	927	
12/26/2014	TRUE	TRUE	FALSE	3.37	10.24	5.98	56%	33%	58%		1.71	7.7	7.6	338.00	193.00	0.57		16,857	9,626			13,165	11,539	808	16,857	9,626	13,145	11,529	808	
12/27/2014	TRUE	TRUE	FALSE	3.25	9.86	5.93	55%	33%	60%		1.66	7.7	7.0									13,461	11,763	808			13,440	11,751	808	
12/28/2014	TRUE	TRUE	FALSE	3.24	9.83	5.78	56%	33%	59%		1.7																			

Date	Butte Break?	CSU Break?	Precip?	Min Influent Flow, mgd	Max Influent Flow, mgd	Avg Influent Flow, mgd	Min % of Avg	Min % of Max	Avg % of Max	Flow Outlier Type	Diurnal Peak Factor (DPF)	30-d Avg of Avg Flow, mgd	7-d Avg of Avg Flow, mgd	Influent TSS Conc., mg/L	Influent BOD Conc., mg/L	BOD/TSS Ratio	Influent NH3-N Conc., mg/L	Avg Inf TSS Load, ppd	Avg Inf BOD Load, ppd	Avg Inf NH3 Load, ppd	Load Outlier Type	30-d Avg of TSS Load, ppd	30-d Avg of BOD Load, ppd	30-d Avg of NH3-N Load, ppd	non-SN TSS Load, ppd	non-SN BOD Load, ppd	non-SN NH3 Load, ppd	30-d Avg of non-SN TSS Load, ppd	30-d Avg of non-SN BOD Load, ppd	30-d Avg of non-SN NH3-N Load, ppd
3/13/2015	FALSE	TRUE	FALSE	3.04	9.58	5.95	51%	32%	62%		1.61	6.2	6.0	186.00				9,230				12,329	12,290	1,102	9,230			12,329	12,290	1,102
3/14/2015	FALSE	TRUE	FALSE	3.17	9.45	5.51	58%	34%	58%		1.72	6.2	5.9									12,329	12,290	1,102				12,329	12,290	1,102
3/15/2015	FALSE	TRUE	FALSE	3.17	9.64	5.38	59%	33%	56%	AvgMax	1.79	6.1	5.9									12,329	12,290	1,102				12,329	12,290	1,102
3/16/2015	FALSE	TRUE	FALSE	3.14	9.06	5.49	57%	35%	61%		1.65	6.1	5.9	223.00				10,210				12,129	12,435	1,102	10,210			12,129	12,435	1,102
3/17/2015	FALSE	TRUE	FALSE	3.15	8.92	5.38	59%	35%	60%		1.66	6.0	5.8				24.96			1,120		12,129	12,435	1,106			1,120	12,129	12,435	1,106
3/18/2015	TRUE	TRUE	FALSE	3.21	8.50	5.40	59%	38%	64%		1.57	6.0	5.7	256.00	215.00	0.84		11,529	9,683			12,082	11,884	1,106	11,529	9,683		12,082	11,884	1,106
3/19/2015	TRUE	TRUE	FALSE	3.18	8.03	5.36	59%	40%	67%		1.50	6.0	5.6									12,082	11,884	1,106				12,082	11,884	1,106
3/20/2015	TRUE	TRUE	FALSE	3.25	7.43	5.44	60%	44%	73%		1.37	5.9	5.5	256.00				11,615				12,049	11,884	1,106	11,615			12,049	11,884	1,106
3/21/2015	TRUE	TRUE	FALSE	3.22	7.80	5.41	60%	41%	69%		1.44	5.9	5.4									11,931	11,983	1,106				11,931	11,983	1,106
3/22/2015	TRUE	TRUE	TRUE	3.20	8.06	5.65	57%	40%	70%		1.43	5.9	5.4									11,931	11,983	1,131				11,931	11,983	1,131
3/23/2015	TRUE	TRUE	TRUE	3.20	8.04	5.89	54%	40%	73%		1.37	5.8	5.5	235.00				11,544				11,860	11,983	1,131	11,544			11,860	11,983	1,131
3/24/2015	TRUE	FALSE	TRUE	3.23	8.45	5.85	55%	38%	69%		1.44	5.8	5.5				24.81			1,210		11,860	11,983	1,147			1,210	11,860	11,983	1,147
3/25/2015	FALSE	FALSE	FALSE	3.17	8.31	5.86	54%	38%	71%		1.42	5.8	5.6	257.00	228.00	0.89		12,560	11,143			11,910	11,815	1,147	12,560	11,143		11,910	11,815	1,147
3/26/2015	FALSE	FALSE	FALSE	3.25	8.12	5.88	55%	40%	72%		1.38	5.8	5.7									11,926	11,815	1,147				11,926	11,815	1,147
3/27/2015	FALSE	FALSE	FALSE	3.24	8.35	5.94	55%	39%	71%		1.41	5.8	5.7	272.00	211.00	0.78		13,475	10,453			12,037	11,588	1,192	13,475	10,453		12,037	11,588	1,192
3/28/2015	FALSE	FALSE	FALSE	3.24	8.72	5.79	56%	37%	66%		1.51	5.8	5.8									11,935	11,559	1,192				11,935	11,559	1,192
3/29/2015	FALSE	FALSE	FALSE	3.21	8.96	5.68	57%	36%	63%		1.58	5.8	5.8									11,935	11,559	1,192				11,935	11,559	1,192
3/30/2015	FALSE	FALSE	FALSE	3.30	8.38	5.91	56%	39%	71%		1.42	5.8	5.9	224.00								11,743	11,559	1,192	11,041			11,743	11,559	1,192
3/31/2015	FALSE	FALSE	FALSE	3.22	8.04	5.95	54%	40%	74%		1.35	5.8	5.9				26.05			1,293		11,743	11,559	1,212			1,293	11,743	11,559	1,212
4/1/2015	FALSE	FALSE	FALSE	3.23	8.19	5.84	55%	39%	71%		1.40	5.8	5.9	294.00	285.00	0.97		14,319	13,881			11,927	11,946	1,212	14,319	13,881		11,927	11,946	1,212
4/2/2015	FALSE	FALSE	FALSE	3.20	8.25	5.84	55%	39%	71%		1.41	5.8	5.9									11,754	11,946	1,212				11,754	11,946	1,212
4/3/2015	FALSE	FALSE	FALSE	3.20	8.23	5.81	55%	39%	71%		1.42	5.8	5.8	294.00				14,246				11,932	11,946	1,220	14,246			11,932	11,946	1,220
4/4/2015	FALSE	FALSE	FALSE	3.21	8.77	5.65	57%	37%	64%		1.55	5.8	5.8									11,940	11,738	1,220				11,940	11,738	1,220
4/5/2015	FALSE	FALSE	TRUE	3.15	8.53	5.52	57%	37%	65%		1.55	5.8	5.8									11,940	11,738	1,220				11,940	11,738	1,220
4/6/2015	FALSE	FALSE	FALSE	3.21	9.21	5.56	57%	37%	65%	inAvgMinM	1.66	5.7	5.8	382.00				17,713				12,271	11,738	1,220	17,713			12,271	11,738	1,220
4/7/2015	FALSE	FALSE	TRUE	3.05	18.00	6.43	47%	17%	36%	inMaxAvgM	2.80	5.7	5.8				23.48			1,259		12,271	11,738	1,228			1,259	12,271	11,738	1,228
4/8/2015	FALSE	FALSE	FALSE	3.32	8.71	6.18	54%	38%	71%		1.41	5.8	5.8	260.00	212.00	0.82		13,401	10,927			12,352	11,602	1,228	13,401	10,927		12,352	11,602	1,228
4/9/2015	FALSE	FALSE	FALSE	3.28	8.39	6.07	54%	39%	72%		1.38	5.8	5.8									12,624	11,602	1,228				12,624	11,602	1,228
4/10/2015	FALSE	FALSE	FALSE	3.29	8.29	6.02	55%	40%	73%		1.38	5.8	5.9									12,624	11,602	1,221				12,624	11,602	1,221
4/11/2015	FALSE	FALSE	FALSE	3.31	8.63	5.86	56%	38%	68%		1.47	5.8	5.9									12,574	11,217	1,221				12,574	11,217	1,221
4/12/2015	FALSE	FALSE	FALSE	3.23	8.60	5.78	56%	38%	67%		1.49	5.7	5.9									12,574	11,217	1,221				12,574	11,217	1,221
4/13/2015	FALSE	FALSE	FALSE	3.21	8.08	5.86	55%	40%	73%		1.38	5.7	6.0	241.00								12,786	11,217	1,221	11,778			12,786	11,217	1,221
4/14/2015	FALSE	FALSE	FALSE	3.45	8.13	5.90	58%	42%	73%		1.38	5.8	6.0				23.20			1,142		12,786	11,217	1,205			1,142	12,786	11,217	1,205
4/15/2015	FALSE	FALSE	FALSE	3.37	8.10	5.88	57%	42%	73%		1.38	5.8	5.9	286.00	216.00	0.76		14,025	10,592			12,881	11,113	1,205	14,025	10,592		12,881	11,113	1,205
4/16/2015	FALSE	FALSE	FALSE	3.44	8.20	5.89	58%	42%	72%		1.39	5.8	5.9									13,104	11,113	1,205				13,104	11,113	1,205
4/17/2015	FALSE	FALSE	FALSE	3.45	7.93	5.88	59%	44%	74%		1.35	5.8	5.9	267.00				13,093				13,103	11,113	1,226	13,093			13,103	11,113	1,226
4/18/2015	FALSE	FALSE	FALSE	3.46	8.28	5.66	61%	42%	68%		1.46	5.8	5.8									13,234	11,399	1,226				13,234	11,399	1,226
4/19/2015	FALSE	FALSE	FALSE	3.32	8.76	5.58	59%	38%	64%		1.57	5.8	5.8									13,234	11,399	1,226				13,234	11,399	1,226
4/20/2015	FALSE	FALSE	FALSE	3.17	9.14	5.84	54%	35%	64%		1.57	5.8	5.8									13,381	11,399	1,226				13,381	11,399	1,226
4/21/2015	FALSE	FALSE	FALSE	3.35	16.66	5.93	56%	20%	36%	inMaxAvgM	2.81	5.8	5.8				25.20			1,246		13,381	11,399	1,230			1,246	13,381	11,399	1,230
4/22/2015	FALSE	FALSE	FALSE	3.37	8.07	5.87	57%	42%	73%		1.37	5.8	5.8	296.00	258.00	0.87		14,491	12,631			13,474	11,604	1,230	14,491	12,631		13,474	11,604	1,230
4/23/2015	FALSE	FALSE	TRUE	3.36	8.08	5.90	57%	42%	73%		1.37	5.8	5.8									13,649	11,604	1,230				13,649	11,604	1,230
4/24/2015	FALSE	FALSE	TRUE	3.39	7.95	5.95	57%	43%	75%		1.34	5.8	5.8									13,649	11,604	1,235				13,649	11,604	1,235
4/25/2015	FALSE	FALSE	TRUE	3.50	8.42	5.98	59%	42%	71%		1.41	5.9	5.8									13,758	11,697	1,235				13,758	11,697	1,235
4/26/2015	FALSE	FALSE	FALSE	3.36	8.19	5.79	58%	41%	71%		1.41	5.9	5.8									13,758	11,697	1,235				13,758	11,697	1,235
4/27/2015	FALSE	FALSE	FALSE	3.37	8.39	6.03	56%	40%	72%		1.39	5.9	5.9									13,790	12,008	1,235				13,790	12,008	1,235
4/28/2015	FALSE	FALSE	FALSE	3.44	8.10	5.88	59%	42%	73%		1.38	5.9	5.9				23.19			1,137		13,790	12,008	1,215			1,137	13,790	12,008	1,215
4/29/2015	FALSE	FALSE	FALSE	3.38	8.03	5.83	58%	42%	73%		1.38	5.9	5.9	333.00	248.00	0.74		16,191	12,058			14,030	12,018	1,215	16,191	12,058		14,030	12,018	1,215
4/30/2015	FALSE	FALSE	FALSE	3.34	7.96	5.79	58%	42%	73%		1.37	5.9	5.9									14,362	12,018	1,215				14,362	12,018	1,215
5/1/2015	FALSE	FALSE	FALSE	3.46	7.88	5.87	59%	44%	74%		1.34	5.9	5.9									14,362	12,018	1,196				14,362	12,018	1,196
5/2/2015	FALSE	FALSE	FALSE	3.42	7.90	5.65	61%	43%	72%		1.40	5.8	5.9																	

Date	Butte Break?	CSU Break?	Precip?	Min Influent Flow, mgd	Max Influent Flow, mgd	Avg Influent Flow, mgd	Min % of Avg	Min % of Max	Avg % of Max	Flow Outlier Type	Diurnal Peak Factor (DPF)	30-d Avg of Avg Flow, mgd	7-d Avg of Avg Flow, mgd	Influent TSS Conc., mg/L	Influent BOD Conc., mg/L	BOD/TSS Ratio	Influent NH3-N Conc., mg/L	Avg Inf TSS Load, ppd	Avg Inf BOD Load, ppd	Avg Inf NH3 Load, ppd	Load Outlier Type	30-d Avg of TSS Load, ppd	30-d Avg of BOD Load, ppd	30-d Avg of NH3-N Load, ppd	non-SN TSS Load, ppd	non-SN BOD Load, ppd	non-SN NH3 Load, ppd	30-d Avg of non-SN TSS Load, ppd	30-d Avg of non-SN BOD Load, ppd	30-d Avg of non-SN NH3-N Load, ppd
5/15/2015	FALSE	FALSE	FALSE	3.48	8.03	5.96	58%	43%	74%		1.35	5.8	5.7									14,084	11,710	1,184				14,084	11,710	1,184
5/16/2015	FALSE	FALSE	FALSE	3.43	8.04	5.66	61%	43%	70%		1.42	5.8	5.7									14,095	11,989	1,184				14,095	11,989	1,184
5/17/2015	FALSE	TRUE	FALSE	3.35	7.91	5.57	60%	42%	70%		1.42	5.8	5.7									14,095	11,989	1,184				14,095	11,989	1,184
5/18/2015	FALSE	TRUE	FALSE	3.38	8.24	5.56	61%	41%	67%		1.48	5.8	5.7									14,346	11,989	1,184				14,346	11,989	1,184
5/19/2015	FALSE	TRUE	FALSE	3.40	7.10	5.51	62%	48%	78%		1.29	5.8	5.7				26.00			1,195		14,346	11,989	1,187			1,195	14,346	11,989	1,187
5/20/2015	FALSE	TRUE	FALSE	3.42	7.18	5.50	62%	48%	77%		1.31	5.8	5.7	259.00	278.00	1.07		11,880	12,752			13,853	12,142	1,187	11,880	12,752		13,853	12,142	1,187
5/21/2015	FALSE	TRUE	FALSE	3.38	7.16	5.50	61%	47%	77%		1.30	5.8	5.6									13,853	12,142	1,187				13,853	12,142	1,187
5/22/2015	FALSE	TRUE	FALSE	3.42	6.87	5.42	63%	50%	79%		1.27	5.7	5.6									13,853	12,142	1,167				13,853	12,142	1,167
5/23/2015	FALSE	TRUE	FALSE	3.43	7.45	5.24	65%	46%	70%		1.42	5.7	5.5									13,693	12,019	1,167				13,693	12,019	1,167
5/24/2015	FALSE	TRUE	FALSE	3.37	7.07	4.98	68%	48%	70%		1.42	5.7	5.4									13,693	12,019	1,167				13,693	12,019	1,167
5/25/2015	FALSE	TRUE	FALSE	3.33	7.38	5.15	65%	45%	70%		1.43	5.7	5.4									13,693	12,019	1,167				13,693	12,019	1,167
5/26/2015	FALSE	TRUE	FALSE	3.36	7.00	5.35	63%	48%	76%		1.31	5.6	5.3									13,693	12,019	1,167				13,693	12,019	1,167
5/27/2015	FALSE	TRUE	FALSE	3.43	7.08	5.41	63%	48%	76%		1.31	5.6	5.3	276.00	201.00	0.73		12,453	9,069			13,445	11,429	1,167	12,453	9,069		13,445	11,429	1,167
5/28/2015	FALSE	TRUE	FALSE	3.42	6.90	5.27	65%	50%	76%		1.31	5.6	5.3									13,445	11,429	1,167				13,445	11,429	1,167
5/29/2015	TRUE	TRUE	FALSE	3.42	6.97	5.32	64%	49%	76%		1.31	5.6	5.3				23.42			1,039		13,445	11,429	1,134			1,039	13,445	11,429	1,134
5/30/2015	TRUE	TRUE	FALSE	3.43	7.15	5.14	67%	48%	72%		1.39	5.6	5.2									12,759	11,272	1,134				12,759	11,272	1,134
5/31/2015	TRUE	TRUE	FALSE	3.33	6.95	5.09	65%	48%	73%		1.37	5.5	5.2									12,759	11,272	1,134				12,759	11,272	1,134
6/1/2015	TRUE	TRUE	FALSE	3.33	6.95	5.09	65%	48%	73%		1.37	5.5	5.2									12,759	11,272	1,134				12,759	11,272	1,134
6/2/2015	TRUE	TRUE	FALSE	2.01	6.89	5.28	38%	29%	77%	MinAvg	1.30	5.5	5.2				24.44			1,076		12,759	11,272	1,120			1,076	12,759	11,272	1,120
6/3/2015	TRUE	TRUE	FALSE	3.42	6.82	5.31	64%	50%	78%		1.28	5.5	5.2	278.00	259.00	0.93		12,311	11,470			12,669	11,312	1,120	12,311	11,470		12,669	11,312	1,120
6/4/2015	TRUE	TRUE	FALSE	3.35	6.70	5.29	63%	50%	79%		1.27	5.5	5.2									12,669	11,312	1,120				12,669	11,312	1,120
6/5/2015	TRUE	TRUE	TRUE	3.45	6.48	5.17	67%	53%	80%		1.25	5.5	5.2									12,669	11,312	1,120				12,669	11,312	1,120
6/6/2015	TRUE	TRUE	FALSE	3.42	6.96	5.10	67%	49%	73%		1.36	5.4	5.2									12,632	11,092	1,120				12,632	11,092	1,120
6/7/2015	TRUE	TRUE	FALSE	3.37	6.67	4.97	68%	51%	75%		1.34	5.4	5.1									12,632	11,092	1,120				12,632	11,092	1,120
6/8/2015	TRUE	TRUE	FALSE	3.41	6.74	5.15	66%	51%	76%		1.31	5.4	5.2									12,632	11,092	1,120				12,632	11,092	1,120
6/9/2015	TRUE	TRUE	FALSE	3.38	6.55	5.18	65%	52%	79%		1.26	5.4	5.2									12,632	11,092	1,120				12,632	11,092	1,120
6/10/2015	TRUE	TRUE	FALSE	3.39	6.55	5.28	64%	52%	81%		1.24	5.4	5.2	178.00	120.00	0.67		7,838	5,284			11,673	9,930	1,120	7,838	5,284		11,673	9,930	1,120
6/11/2015	TRUE	TRUE	FALSE	3.44	6.43	5.20	66%	53%	81%		1.24	5.4	5.2				27.25			1,182		11,673	9,930	1,132			1,182	11,673	9,930	1,132
6/12/2015	TRUE	TRUE	FALSE	3.50	6.41	5.10	69%	55%	80%		1.26	5.3	5.1									11,673	9,930	1,123				11,673	9,930	1,123
6/13/2015	TRUE	TRUE	FALSE	3.50	6.43	4.95	71%	54%	77%	MinAvg	1.30	5.3	5.1									11,121	9,644	1,123				11,121	9,644	1,123
6/14/2015	TRUE	TRUE	FALSE	3.39	6.43	4.96	68%	53%	77%		1.30	5.3	5.1									11,121	9,644	1,123				11,121	9,644	1,123
6/15/2015	TRUE	TRUE	FALSE	3.40	6.46	5.16	66%	53%	80%		1.25	5.3	5.1									11,121	9,644	1,123				11,121	9,644	1,123
6/16/2015	TRUE	TRUE	FALSE	3.51	6.34	5.20	68%	55%	82%	MinMax	1.22	5.2	5.1									11,121	9,644	1,123				11,121	9,644	1,123
6/17/2015	TRUE	TRUE	FALSE	3.52	6.51	5.24	67%	54%	80%		1.24	5.2	5.2	250.00	216.00	0.86		10,925	9,440			11,082	9,603	1,123	10,925	9,440		11,082	9,603	1,123
6/18/2015	TRUE	TRUE	FALSE	3.41	6.49	5.19	66%	53%	80%		1.25	5.2	5.1				25.89			1,121		11,082	9,603	1,123			1,121	11,082	9,603	1,123
6/19/2015	TRUE	TRUE	FALSE	3.48	6.33	5.19	67%	55%	82%	MinMax	1.22	5.2	5.1									11,082	9,603	1,104				11,082	9,603	1,104
6/20/2015	TRUE	TRUE	FALSE	3.47	6.49	5.02	69%	53%	77%		1.29	5.2	5.1									10,882	8,816	1,104				10,882	8,816	1,104
6/21/2015	TRUE	TRUE	FALSE	3.40	6.52	4.98	68%	52%	76%		1.31	5.2	5.1									10,882	8,816	1,104				10,882	8,816	1,104
6/22/2015	TRUE	TRUE	FALSE	3.45	6.55	5.23	66%	53%	80%		1.25	5.2	5.1				27.92			1,218		10,882	8,816	1,127			1,218	10,882	8,816	1,127
6/23/2015	TRUE	TRUE	FALSE	3.50	6.47	5.21	67%	54%	81%		1.24	5.2	5.1									10,882	8,816	1,127				10,882	8,816	1,127
6/24/2015	TRUE	TRUE	FALSE	3.52	6.74	5.26	67%	52%	78%		1.28	5.2	5.2	301.00	252.00	0.84		13,204	11,055			11,346	9,264	1,127	13,204	11,055		11,346	9,264	1,127
6/25/2015	TRUE	TRUE	FALSE	3.53	6.50	5.26	67%	54%	81%		1.24	5.2	5.2									11,346	9,264	1,127				11,346	9,264	1,127
6/26/2015	TRUE	TRUE	FALSE	3.54	6.53	5.19	68%	54%	79%		1.26	5.2	5.2									11,346	9,264	1,127				11,346	9,264	1,127
6/27/2015	TRUE	TRUE	FALSE	3.50	6.48	5.05	69%	54%	78%		1.28	5.2	5.2									11,070	9,312	1,127				11,070	9,312	1,127
6/28/2015	TRUE	TRUE	FALSE	3.45	6.64	4.99	69%	52%	75%		1.33	5.2	5.1									11,070	9,312	1,127				11,070	9,312	1,127
6/29/2015	TRUE	TRUE	FALSE	3.45	6.32	5.12	67%	55%	81%		1.23	5.1	5.2				25.52			1,090		11,070	9,312	1,137			1,090	11,070	9,312	1,137
6/30/2015	TRUE	TRUE	FALSE	3.40	6.27	5.09	67%	54%	81%		1.23	5.1	5.1									11,070	9,312	1,137				11,070	9,312	1,137
7/1/2015	TRUE	TRUE	FALSE	3.55	6.55	5.19	68%	54%	79%		1.26	5.1	5.1	255.00	178.00	0.70		11,038	7,705			11,063	8,991	1,137	11,038	7,705		11,063	8,991	1,137
7/2/2015	TRUE	TRUE	FALSE	3.43	6.47	5.10	67%	53%	79%		1.27	5.1	5.1									11,063	8,991	1,137				11,063	8,991	1,137
7/3/2015	TRUE	TRUE	FALSE	3.45	6.85	5.05	68%	50%	74%		1.36	5.1	5.1									11,063	8,991	1,152				11,063	8,991	1,152
7/4/2015	TRUE	TRUE	FALSE	3.44	6.13	4.71	73%	56%	77%	inAvgMinM	1.30	5.1	5.1									10,751	8,371	1,152				10,751	8,371	1,152
7/5/2015	TRUE	TRUE	FALSE	3.34	6.16	4.75	70%	54%	77%	MinAvg	1.30	5.1	5.1									10,751	8,371	1,152				10,75		

Date	Butte Break?	CSU Break?	Precip?	Min Influent Flow, mgd	Max Influent Flow, mgd	Avg Influent Flow, mgd	Min % of Avg	Min % of Max	Avg % of Max	Flow Outlier Type	Diurnal Peak Factor (DPF)	30-d Avg of Avg Flow, mgd	7-d Avg of Avg Flow, mgd	Influent TSS Conc., mg/L	Influent BOD Conc., mg/L	BOD/TSS Ratio	Influent NH3-N Conc., mg/L	Avg Inf TSS Load, ppd	Avg Inf BOD Load, ppd	Avg Inf NH3 Load, ppd	Load Outlier Type	30-d Avg of TSS Load, ppd	30-d Avg of BOD Load, ppd	30-d Avg of NH3-N Load, ppd	non-SN TSS Load, ppd	non-SN BOD Load, ppd	non-SN NH3 Load, ppd	30-d Avg of non-SN TSS Load, ppd	30-d Avg of non-SN BOD Load, ppd	30-d Avg of non-SN NH3-N Load, ppd
7/17/2015	TRUE	TRUE	FALSE	3.46	6.58	5.14	67%	53%	78%		1.28	5.1	5.1									11,539	9,261	1,183				11,539	9,261	1,183
7/18/2015	TRUE	TRUE	FALSE	3.41	6.42	4.87	70%	53%	76%	MinAvg	1.32	5.1	5.1									11,692	9,216	1,183				11,692	9,216	1,183
7/19/2015	TRUE	TRUE	FALSE	3.34	6.24	4.86	69%	54%	78%		1.28	5.1	5.1									11,692	9,216	1,198				11,692	9,216	1,198
7/20/2015	TRUE	TRUE	FALSE	3.35	6.24	5.06	66%	54%	81%		1.23	5.1	5.1									11,692	9,216	1,198				11,692	9,216	1,198
7/21/2015	TRUE	TRUE	FALSE	3.48	6.47	5.08	69%	54%	79%		1.27	5.1	5.1									11,692	9,216	1,198				11,692	9,216	1,198
7/22/2015	TRUE	TRUE	FALSE	3.57	6.46	5.19	69%	55%	80%	MinMax	1.24	5.1	5.1	259.00	208.00	0.80		11,211	9,003			11,596	9,174	1,198	11,211	9,003		11,596	9,174	1,198
7/23/2015	TRUE	TRUE	FALSE	3.58	6.22	5.05	71%	58%	81%	inAvgMinM	1.23	5.1	5.1		27.50					1,158		11,596	9,174	1,183		1,158		11,596	9,174	1,183
7/24/2015	TRUE	TRUE	FALSE	3.32	6.85	5.12	65%	48%	75%		1.34	5.1	5.1									11,596	9,174	1,183				11,596	9,174	1,183
7/25/2015	TRUE	TRUE	FALSE	3.37	6.59	4.90	69%	51%	74%		1.34	5.1	5.0									11,194	8,704	1,183				11,194	8,704	1,183
7/26/2015	TRUE	TRUE	FALSE	3.26	6.26	4.81	68%	52%	77%		1.30	5.1	5.0									11,194	8,704	1,183				11,194	8,704	1,183
7/27/2015	TRUE	TRUE	FALSE	3.34	6.43	5.04	66%	52%	78%		1.28	5.1	5.0									11,194	8,704	1,183				11,194	8,704	1,183
7/28/2015	TRUE	TRUE	FALSE	3.31	6.39	4.97	67%	52%	78%		1.29	5.1	5.0									11,194	8,704	1,183				11,194	8,704	1,183
7/29/2015	TRUE	TRUE	FALSE	3.46	6.37	5.04	69%	54%	79%		1.26	5.1	5.0	260.00	239.00	0.92		10,929	10,046			11,141	8,972	1,183	10,929	10,046		11,141	8,972	1,183
7/30/2015	TRUE	TRUE	FALSE	3.40	6.77	5.12	66%	50%	76%		1.32	5.1	5.0				26.04			1,112		11,141	8,972	1,189			1,112	11,141	8,972	1,189
7/31/2015	TRUE	TRUE	FALSE	3.48	6.68	5.20	67%	52%	78%		1.28	5.1	5.0									11,141	8,972	1,189				11,141	8,972	1,189
8/1/2015	TRUE	TRUE	FALSE	3.40	6.54	4.95	69%	52%	76%		1.32	5.1	5.0									11,167	9,289	1,189				11,167	9,289	1,189
8/2/2015	TRUE	TRUE	FALSE	3.33	6.78	4.99	67%	49%	74%		1.36	5.1	5.0									11,167	9,289	1,189				11,167	9,289	1,189
8/3/2015	TRUE	TRUE	FALSE	3.37	6.77	5.16	65%	50%	76%		1.31	5.1	5.1									11,167	9,289	1,189				11,167	9,289	1,189
8/4/2015	TRUE	TRUE	FALSE	3.39	6.75	5.23	65%	50%	77%		1.29	5.1	5.1									11,167	9,289	1,189				11,167	9,289	1,189
8/5/2015	TRUE	TRUE	FALSE	3.42	6.45	5.15	66%	53%	80%		1.25	5.1	5.1	277.00	212.00	0.77		11,897	9,106			11,313	9,252	1,189	11,897	9,106		11,313	9,252	1,189
8/6/2015	TRUE	TRUE	FALSE	3.45	6.67	5.20	66%	52%	78%		1.28	5.1	5.1				32.10			1,392		11,313	9,252	1,229		1,392		11,313	9,252	1,229
8/7/2015	TRUE	TRUE	FALSE	3.42	6.69	5.15	66%	51%	77%		1.30	5.1	5.1									11,313	9,252	1,229				11,313	9,252	1,229
8/8/2015	TRUE	TRUE	FALSE	3.41	6.77	5.04	68%	50%	74%		1.34	5.1	5.1									11,447	9,469	1,229				11,447	9,469	1,229
8/9/2015	TRUE	TRUE	FALSE	3.32	6.58	4.96	67%	50%	75%		1.33	5.1	5.1									11,447	9,469	1,204				11,447	9,469	1,204
8/10/2015	TRUE	TRUE	FALSE	3.41	6.79	5.26	65%	50%	77%		1.29	5.1	5.1									11,447	9,469	1,204				11,447	9,469	1,204
8/11/2015	TRUE	TRUE	FALSE	3.42	7.39	5.26	65%	46%	71%		1.40	5.1	5.2									11,447	9,469	1,204				11,447	9,469	1,204
8/12/2015	TRUE	TRUE	FALSE	3.46	6.59	5.29	65%	53%	80%		1.25	5.1	5.2	275.00	188.00	0.68		12,133	8,294			11,584	9,234	1,204	12,133	8,294		11,584	9,234	1,204
8/13/2015	TRUE	TRUE	FALSE	3.42	6.70	5.20	66%	51%	78%		1.29	5.1	5.2				24.95			1,082		11,584	9,234	1,179		1,082		11,584	9,234	1,179
8/14/2015	TRUE	TRUE	FALSE	3.42	16.54	5.18	66%	21%	31%	inMaxAvgM	3.19	5.1	5.2									11,584	9,234	1,179				11,584	9,234	1,179
8/15/2015	TRUE	TRUE	FALSE	3.43	16.48	5.13	67%	21%	31%	inMaxAvgM	3.21	5.1	5.2									11,542	9,112	1,179				11,542	9,112	1,179
8/16/2015	TRUE	TRUE	FALSE	3.34	6.72	5.09	66%	50%	76%		1.32	5.1	5.2									11,542	9,112	1,186				11,542	9,112	1,186
8/17/2015	TRUE	TRUE	FALSE	3.35	6.75	5.33	63%	50%	79%		1.27	5.1	5.2									11,542	9,112	1,186				11,542	9,112	1,186
8/18/2015	TRUE	TRUE	FALSE	3.39	7.23	5.32	64%	47%	74%		1.36	5.1	5.2									11,542	9,112	1,186				11,542	9,112	1,186
8/19/2015	TRUE	TRUE	FALSE	3.35	8.90	5.65	59%	38%	63%		1.58	5.1	5.3	301.00	230.00	0.76		14,183	10,838			12,071	9,457	1,186	14,183	10,838		12,071	9,457	1,186
8/20/2015	TRUE	TRUE	FALSE	3.23	7.51	5.70	57%	43%	76%		1.32	5.2	5.4				27.40			1,303		12,071	9,457	1,209		1,303		12,071	9,457	1,209
8/21/2015	TRUE	TRUE	FALSE	3.21	7.34	5.61	57%	44%	76%		1.31	5.2	5.5									12,071	9,457	1,209				12,071	9,457	1,209
8/22/2015	TRUE	TRUE	FALSE	3.46	7.37	5.47	63%	47%	74%		1.35	5.2	5.5									12,286	9,571	1,209				12,286	9,571	1,209
8/23/2015	TRUE	TRUE	FALSE	3.38	7.74	5.54	61%	44%	72%		1.40	5.2	5.5									12,286	9,571	1,222				12,286	9,571	1,222
8/24/2015	TRUE	TRUE	FALSE	3.27	7.66	5.66	58%	43%	74%		1.35	5.2	5.5									12,286	9,571	1,222				12,286	9,571	1,222
8/25/2015	FALSE	FALSE	FALSE	3.36	11.01	5.64	60%	31%	51%	AvgMax	1.95	5.2	5.6									12,286	9,571	1,222				12,286	9,571	1,222
8/26/2015	FALSE	FALSE	FALSE	3.28	7.81	5.62	58%	42%	72%		1.39	5.3	5.6	238.00	232.00	0.97		11,155	10,874			12,059	9,832	1,222	10,692	10,762		11,967	9,809	1,222
8/27/2015	FALSE	FALSE	FALSE	3.20	7.54	5.56	58%	42%	74%		1.36	5.3	5.6				29.67			1,376		12,059	9,832	1,253		1,376		11,967	9,809	1,253
8/28/2015	FALSE	FALSE	FALSE	3.27	7.59	5.72	57%	43%	75%		1.33	5.3	5.6									12,059	9,832	1,253				11,967	9,809	1,253
8/29/2015	FALSE	FALSE	TRUE	3.31	7.68	5.50	60%	43%	72%		1.40	5.3	5.6									12,342	9,778	1,253				12,226	9,750	1,253
8/30/2015	FALSE	FALSE	FALSE	3.23	7.74	5.50	59%	42%	71%		1.41	5.3	5.6									12,342	9,778	1,288				12,226	9,750	1,288
8/31/2015	FALSE	FALSE	FALSE	3.32	7.71	5.61	59%	43%	73%		1.37	5.3	5.6									12,342	9,778	1,288				12,226	9,750	1,288
9/1/2015	FALSE	FALSE	FALSE	3.30	7.68	5.59	59%	43%	73%		1.37	5.4	5.6									12,342	9,778	1,288				12,226	9,750	1,288
9/2/2015	FALSE	FALSE	FALSE	3.31	7.89	5.70	58%	42%	72%		1.38	5.4	5.6	276.00	171.00	0.62		13,120	8,129			12,498	9,448	1,288	13,120	8,129		12,405	9,426	1,288
9/3/2015	FALSE	FALSE	FALSE	3.34	14.25	5.79	58%	23%	41%	inMaxAvgM	2.46	5.4	5.6				26.79			1,294		12,498	9,448	1,289		1,294		12,405	9,426	1,289
9/4/2015	FALSE	FALSE	FALSE	3.46	8.27	5.73	60%	42%	69%		1.44	5.4	5.6									12,498	9,448	1,289				12,405	9,426	1,289
9/5/2015	FALSE	FALSE	FALSE	3.36	7.78	5.35	63%	43%	69%		1.45	5.4	5.6									12,648	9,534	1,289				12,532	9,506	1,289
9/6/2015	FALSE	FALSE	FALSE	3.41	7.71	5.15	66%	44%	67%		1.50	5.4	5.5									12,648	9,534	1,264				12,532	9,506	1,264
9/7/20																														

Date	Butte Break?	CSU Break?	Precip?	Min Influent Flow, mgd	Max Influent Flow, mgd	Avg Influent Flow, mgd	Min % of Avg	Min % of Max	Avg % of Max	Flow Outlier Type	Diurnal Peak Factor (DPF)	30-d Avg of Avg Flow, mgd	7-d Avg of Avg Flow, mgd	Influent TSS Conc., mg/L	Influent BOD Conc., mg/L	BOD/TSS Ratio	Influent NH3-N Conc., mg/L	Avg Inf TSS Load, ppd	Avg Inf BOD Load, ppd	Avg Inf NH3 Load, ppd	Load Outlier Type	30-d Avg of TSS Load, ppd	30-d Avg of BOD Load, ppd	30-d Avg of NH3-N Load, ppd	non-SN TSS Load, ppd	non-SN BOD Load, ppd	non-SN NH3 Load, ppd	30-d Avg of non-SN TSS Load, ppd	30-d Avg of non-SN BOD Load, ppd	30-d Avg of non-SN NH3-N Load, ppd
9/18/2015	FALSE	FALSE	FALSE	3.25	13.97	5.78	56%	23%	41%	inMaxAvgM	2.42	5.6	5.7									13,685	10,240	1,356				13,593	10,217	1,356
9/19/2015	FALSE	FALSE	FALSE	3.43	7.80	5.51	62%	44%	71%		1.42	5.6	5.7									13,561	10,090	1,356				13,445	10,062	1,356
9/20/2015	FALSE	FALSE	FALSE	3.32	8.22	5.50	60%	40%	67%		1.49	5.6	5.7									13,561	10,090	1,370				13,445	10,062	1,370
9/21/2015	FALSE	FALSE	FALSE	3.35	8.01	5.67	59%	42%	71%		1.41	5.6	5.7									13,561	10,090	1,370				13,445	10,062	1,370
9/22/2015	FALSE	FALSE	FALSE	3.34	13.06	5.70	59%	26%	44%	AvgMax	2.29	5.6	5.6									13,561	10,090	1,370				13,445	10,062	1,370
9/23/2015	FALSE	FALSE	FALSE	3.43	13.55	5.67	60%	25%	42%	AvgMax	2.39	5.6	5.6	257.00	251.00	0.98		12,153	11,869			13,279	10,446	1,370	12,153	11,869		13,186	10,423	1,370
9/24/2015	FALSE	FALSE	FALSE	3.40	8.20	5.61	61%	41%	68%		1.46	5.6	5.6									13,279	10,446	1,370				13,186	10,423	1,370
9/25/2015	FALSE	FALSE	FALSE	3.47	7.84	5.56	62%	44%	71%		1.41	5.6	5.6									13,279	10,446	1,370				13,186	10,423	1,370
9/26/2015	FALSE	FALSE	FALSE	3.30	7.78	5.34	62%	42%	69%		1.46	5.6	5.5									13,810	10,339	1,370				13,810	10,339	1,370
9/27/2015	FALSE	FALSE	FALSE	3.36	13.88	5.53	61%	24%	40%	inMaxAvgM	2.51	5.6	5.5									13,810	10,339	1,368				13,810	10,339	1,368
9/28/2015	FALSE	FALSE	FALSE	3.32	8.03	5.52	60%	41%	69%		1.45	5.6	5.5									13,810	10,339	1,368				13,810	10,339	1,368
9/29/2015	FALSE	FALSE	FALSE	3.19	13.78	5.60	57%	23%	41%	inMaxAvgM	2.46	5.6	5.5				33.13			1,547		13,810	10,339	1,413			1,547	13,810	10,339	1,413
9/30/2015	FALSE	FALSE	FALSE	3.40	8.44	5.73	59%	40%	68%		1.47	5.6	5.6									13,810	10,339	1,413				13,810	10,339	1,413
10/1/2015	FALSE	FALSE	TRUE	3.36	13.19	5.67	59%	25%	43%	AvgMax	2.33	5.6	5.6									13,810	10,339	1,413				13,810	10,339	1,413
10/2/2015	FALSE	FALSE	FALSE	3.33	8.02	5.77	58%	42%	72%		1.39	5.6	5.6	252.00	345.00	1.37		12,127	16,602			13,473	11,591	1,413	12,127	16,602		13,473	11,591	1,413
10/3/2015	FALSE	FALSE	FALSE	3.41	8.23	5.72	62%	41%	67%		1.49	5.6	5.6									13,562	12,457	1,413				13,562	12,457	1,413
10/4/2015	FALSE	FALSE	FALSE	3.36	8.57	5.55	61%	39%	65%		1.54	5.6	5.6									13,562	12,457	1,453				13,562	12,457	1,453
10/5/2015	FALSE	FALSE	FALSE	3.40	13.90	5.75	59%	24%	41%	inMaxAvgM	2.42	5.6	5.6									13,562	12,457	1,453				13,562	12,457	1,453
10/6/2015	FALSE	FALSE	FALSE	3.37	8.31	5.67	59%	41%	68%		1.47	5.6	5.6									13,562	12,457	1,453				13,562	12,457	1,453
10/7/2015	FALSE	FALSE	FALSE	3.38	8.12	5.70	59%	42%	70%		1.42	5.6	5.7	279.00	232.00	0.83		13,263	11,029			13,502	12,171	1,453	13,263	11,029		13,502	12,171	1,453
10/8/2015	FALSE	FALSE	FALSE	3.34	8.34	5.72	58%	40%	69%		1.46	5.6	5.7				28.20			1,345		13,502	12,171	1,426			1,345	13,502	12,171	1,426
10/9/2015	FALSE	FALSE	FALSE	3.44	8.16	5.74	60%	42%	70%		1.42	5.6	5.7									13,502	12,171	1,426				13,502	12,171	1,426
10/10/2015	FALSE	FALSE	FALSE	3.42	8.43	5.52	62%	41%	65%		1.53	5.6	5.6									13,502	12,171	1,426				13,502	12,171	1,426
10/11/2015	FALSE	FALSE	FALSE	3.38	8.30	5.51	61%	41%	66%		1.51	5.6	5.6									13,390	13,153	1,426				13,390	13,153	1,426
10/12/2015	FALSE	FALSE	FALSE	3.38	8.39	5.69	59%	40%	68%		1.47	5.6	5.7									13,390	13,153	1,468				13,390	13,153	1,468
10/13/2015	FALSE	FALSE	FALSE	3.35	8.18	5.67	59%	41%	69%		1.44	5.6	5.7									13,390	13,153	1,468				13,390	13,153	1,468
10/14/2015	FALSE	FALSE	FALSE	3.40	8.66	5.67	60%	39%	65%		1.53	5.6	5.7	236.00	174.00	0.74		11,160	8,228			12,944	12,168	1,468	11,160	8,228		12,944	12,168	1,468
10/15/2015	FALSE	FALSE	FALSE	3.36	8.11	5.63	60%	41%	69%		1.44	5.6	5.6				32.30			1,517		12,944	12,168	1,480			1,517	12,944	12,168	1,480
10/16/2015	FALSE	FALSE	FALSE	3.36	8.15	5.66	59%	41%	69%		1.44	5.6	5.6									12,944	12,168	1,480				12,944	12,168	1,480
10/17/2015	FALSE	FALSE	TRUE	3.35	8.50	5.54	60%	39%	65%		1.53	5.6	5.6									12,176	11,932	1,480				12,176	11,932	1,480
10/18/2015	FALSE	FALSE	FALSE	3.33	8.66	5.59	60%	38%	65%		1.55	5.6	5.6									12,176	11,932	1,470				12,176	11,932	1,470
10/19/2015	FALSE	FALSE	TRUE	3.40	13.70	5.78	59%	25%	42%	inMaxAvgM	2.37	5.6	5.6									12,176	11,932	1,470				12,176	11,932	1,470
10/20/2015	FALSE	FALSE	FALSE	3.36	8.49	5.70	59%	40%	67%		1.49	5.6	5.6									12,176	11,932	1,470				12,176	11,932	1,470
10/21/2015	FALSE	FALSE	FALSE	3.38	8.52	5.75	59%	40%	67%		1.48	5.6	5.6	281.00	236.00	0.84		13,475	11,317			12,436	11,809	1,470	13,475	11,317		12,436	11,809	1,470
10/22/2015	FALSE	FALSE	FALSE	3.36	8.17	5.69	59%	41%	70%		1.44	5.6	5.7									12,436	11,809	1,470				12,436	11,809	1,470
10/23/2015	FALSE	FALSE	FALSE	3.40	8.24	5.73	59%	41%	70%		1.44	5.6	5.7									12,436	11,809	1,470				12,436	11,809	1,470
10/24/2015	FALSE	FALSE	FALSE	3.35	8.72	5.54	60%	38%	64%		1.57	5.6	5.6									12,506	11,794	1,470				12,506	11,794	1,470
10/25/2015	FALSE	FALSE	FALSE	3.35	8.63	5.57	60%	39%	65%		1.55	5.6	5.7									12,506	11,794	1,470				12,506	11,794	1,470
10/26/2015	FALSE	FALSE	FALSE	3.33	8.35	5.68	59%	40%	68%		1.47	5.6	5.7									12,506	11,794	1,470				12,506	11,794	1,470
10/27/2015	FALSE	FALSE	FALSE	3.36	8.17	5.69	59%	41%	70%		1.44	5.6	5.7									12,506	11,794	1,470				12,506	11,794	1,470
10/28/2015	FALSE	FALSE	TRUE	3.38	8.45	5.69	59%	40%	67%		1.49	5.6	5.7	296.00	238.00	0.80		14,047	11,294			12,814	11,694	1,470	14,047	11,294		12,814	11,694	1,470
10/29/2015	FALSE	FALSE	FALSE	3.34	8.20	5.75	58%	41%	70%		1.43	5.7	5.7				32.05			1,537		12,814	11,694	1,487			1,537	12,814	11,694	1,487
10/30/2015	FALSE	FALSE	FALSE	3.38	8.20	5.80	58%	41%	71%		1.41	5.7	5.7									12,814	11,694	1,466				12,814	11,694	1,466
10/31/2015	FALSE	FALSE	FALSE	3.40	9.21	5.75	59%	37%	62%		1.60	5.7	5.7									12,814	11,694	1,466				12,814	11,694	1,466
11/1/2015	FALSE	FALSE	TRUE	3.35	8.92	5.73	58%	38%	64%		1.56	5.7	5.7									12,814	11,694	1,466				12,814	11,694	1,466
11/2/2015	FALSE	FALSE	TRUE	3.43	9.06	6.00	57%	38%	66%		1.51	5.7	5.8									12,986	10,467	1,466				12,986	10,467	1,466
11/3/2015	FALSE	FALSE	FALSE	3.26	9.06	6.03	54%	36%	67%		1.50	5.7	5.8									12,986	10,467	1,466				12,986	10,467	1,466
11/4/2015	FALSE	FALSE	TRUE	3.39	9.04	5.90	57%	38%	65%		1.53	5.7	5.8				31.89			1,569		12,986	10,467	1,492			1,569	12,986	10,467	1,492
11/5/2015	FALSE	FALSE	FALSE	3.44	8.60	5.83	59%	40%	68%		1.48	5.7	5.8	266.00	267.00	1.00		12,934	12,982			12,976	10,970	1,492	12,934	12,982		12,976	10,970	1,492
11/6/2015	FALSE	FALSE	FALSE	3.47	8.67	5.83	60%	40%	67%		1.49	5.7	5.9									12,976	10,970	1,492				12,976	10,970	1,492
11/7/2015	FALSE	FALSE	FALSE	3.42	8.69	5.64	61%	39%	65%		1.54	5.7	5.8									12,904	10,955	1,492				12,904	10,955	1,492
11/8/2015	FALSE	FALSE	TRUE	3.37	9.08	5.76	59%	37%	63%		1.58	5.7	5.8																	

Date	Butte Break?	CSU Break?	Precip?	Min Influent Flow, mgd	Max Influent Flow, mgd	Avg Influent Flow, mgd	Min % of Avg	Min % of Max	Avg % of Max	Flow Outlier Type	Diurnal Peak Factor (DPF)	30-d Avg of Avg Flow, mgd	7-d Avg of Avg Flow, mgd	Influent TSS Conc., mg/L	Influent BOD Conc., mg/L	BOD/TSS Ratio	Influent NH3-N Conc., mg/L	Avg Inf TSS Load, ppd	Avg Inf BOD Load, ppd	Avg Inf NH3 Load, ppd	Load Outlier Type	30-d Avg of TSS Load, ppd	30-d Avg of BOD Load, ppd	30-d Avg of NH3-N Load, ppd	non-SN TSS Load, ppd	non-SN BOD Load, ppd	non-SN NH3 Load, ppd	30-d Avg of non-SN TSS Load, ppd	30-d Avg of non-SN BOD Load, ppd	30-d Avg of non-SN NH3-N Load, ppd
11/20/2015	FALSE	TRUE	FALSE	3.37	8.24	5.74	59%	41%	70%		1.44	5.8	5.9									13,382	11,240	1,453				13,382	11,240	1,453
11/21/2015	FALSE	TRUE	FALSE	3.40	8.67	5.51	62%	39%	64%		1.57	5.8	5.8									13,359	11,220	1,453				13,359	11,220	1,453
11/22/2015	FALSE	TRUE	FALSE	3.42	11.27	5.31	64%	30%	47%	AvgMax	2.12	5.8	5.8									13,359	11,220	1,453				13,359	11,220	1,453
11/23/2015	FALSE	TRUE	FALSE	3.43	10.67	5.39	64%	32%	51%	AvgMax	1.98	5.8	5.8									13,359	11,220	1,453				13,359	11,220	1,453
11/24/2015	FALSE	TRUE	FALSE	3.49	7.52	5.42	64%	46%	72%		1.39	5.8	5.7									13,359	11,220	1,453				13,359	11,220	1,453
11/25/2015	TRUE	TRUE	FALSE	3.43	8.08	5.49	62%	42%	68%		1.47	5.8	5.6	283.00	241.00	0.85		12,958	11,035			13,278	11,183	1,453	12,958	11,035		13,278	11,183	1,453
11/26/2015	TRUE	TRUE	FALSE	3.40	8.38	5.07	67%	41%	61%		1.65	5.8	5.4									13,278	11,183	1,453				13,278	11,183	1,453
11/27/2015	TRUE	TRUE	FALSE	3.42	7.49	4.96	69%	46%	66%		1.51	5.7	5.4									13,278	11,183	1,453				13,278	11,183	1,453
11/28/2015	TRUE	TRUE	FALSE	3.36	7.84	5.20	65%	43%	66%		1.51	5.7	5.3									13,086	11,155	1,453				13,086	11,155	1,453
11/29/2015	TRUE	TRUE	FALSE	3.32	8.49	5.47	61%	39%	64%		1.55	5.7	5.3									13,086	11,155	1,425				13,086	11,155	1,425
11/30/2015	TRUE	TRUE	FALSE	3.39	8.33	5.74	59%	41%	69%		1.45	5.7	5.3									13,086	11,155	1,425				13,086	11,155	1,425
12/1/2015	FALSE	FALSE	FALSE	3.42	8.32	5.72	60%	41%	69%		1.45	5.7	5.4									13,086	11,155	1,425				13,086	11,155	1,425
12/2/2015	FALSE	FALSE	FALSE	3.43	8.07	5.71	60%	43%	71%		1.41	5.7	5.4	299.00	265.00	0.89		14,239	12,620			13,317	11,448	1,425	14,239	12,620		13,317	11,448	1,425
12/3/2015	FALSE	FALSE	TRUE	3.45	8.23	5.80	59%	42%	70%		1.42	5.7	5.5				33.00			1,596		13,317	11,448	1,468			1,596	13,317	11,448	1,468
12/4/2015	FALSE	FALSE	FALSE	3.46	8.22	5.79	60%	42%	70%		1.42	5.7	5.5									13,317	11,448	1,468				13,317	11,448	1,468
12/5/2015	FALSE	FALSE	FALSE	3.44	8.84	5.70	60%	39%	64%		1.55	5.7	5.6									13,317	11,448	1,434				13,317	11,448	1,434
12/6/2015	FALSE	FALSE	TRUE	3.43	9.07	5.76	60%	38%	64%		1.57	5.7	5.7									13,413	11,065	1,434				13,413	11,065	1,434
12/7/2015	FALSE	FALSE	TRUE	3.40	8.28	5.80	59%	41%	70%		1.43	5.7	5.8									13,413	11,065	1,434				13,413	11,065	1,434
12/8/2015	FALSE	FALSE	TRUE	3.43	7.99	5.79	59%	43%	72%		1.38	5.7	5.8									13,413	11,065	1,434				13,413	11,065	1,434
12/9/2015	FALSE	FALSE	TRUE	3.35	8.26	5.88	57%	41%	71%		1.40	5.7	5.8	318.00	216.00	0.68		15,594	10,592			13,849	10,970	1,434	15,594	10,592		13,849	10,970	1,434
12/10/2015	FALSE	FALSE	TRUE	3.38	8.39	5.98	57%	40%	71%		1.40	5.7	5.8				29.90			1,491		13,849	10,970	1,448			1,491	13,849	10,970	1,448
12/11/2015	FALSE	FALSE	FALSE	3.45	8.29	5.89	59%	42%	71%		1.41	5.7	5.8									13,849	10,970	1,448				13,849	10,970	1,448
12/12/2015	FALSE	FALSE	FALSE	3.42	9.13	5.78	59%	37%	63%		1.58	5.7	5.8									13,849	10,970	1,448				13,849	10,970	1,448
12/13/2015	FALSE	FALSE	TRUE	3.39	9.65	5.99	57%	35%	62%		1.61	5.7	5.9									13,849	10,970	1,478				13,849	10,970	1,478
12/14/2015	FALSE	FALSE	FALSE	3.45	8.66	6.08	57%	40%	70%		1.42	5.7	5.9									13,859	11,403	1,478				13,859	11,403	1,478
12/15/2015	FALSE	FALSE	FALSE	3.45	8.57	6.01	57%	40%	70%		1.43	5.7	5.9									13,859	11,403	1,478				13,859	11,403	1,478
12/16/2015	FALSE	FALSE	FALSE	3.46	8.42	5.90	59%	41%	70%		1.43	5.7	5.9	618.00	484.00	0.78		30,409	23,816		TSS	13,859	13,886	1,478	30,409	23,816		13,859	13,886	1,478
12/17/2015	FALSE	FALSE	FALSE	3.45	8.28	5.87	59%	42%	71%		1.41	5.7	5.9				28.50			1,395		13,859	13,886	1,457			1,395	13,859	13,886	1,457
12/18/2015	TRUE	TRUE	TRUE	3.41	9.22	6.28	54%	37%	68%		1.47	5.7	6.0									13,859	13,886	1,457				13,859	13,886	1,457
12/19/2015	TRUE	TRUE	TRUE	4.33	10.68	7.28	59%	41%	68%		1.47	5.8	6.1									14,264	14,516	1,457				14,264	14,516	1,457
12/20/2015	TRUE	TRUE	TRUE	3.64	16.48	6.29	58%	22%	38%	inMaxAvgM	2.62	5.8	6.2									14,264	14,516	1,494				14,264	14,516	1,494
12/21/2015	TRUE	TRUE	TRUE	4.10	10.15	6.71	61%	40%	66%		1.51	5.8	6.3									14,264	14,516	1,494				14,264	14,516	1,494
12/22/2015	TRUE	TRUE	TRUE	4.04	9.45	6.61	61%	43%	70%		1.43	5.8	6.4				16.80			926		14,264	14,516	1,352			926	14,264	14,516	1,352
12/23/2015	TRUE	TRUE	FALSE	3.73	8.93	6.13	61%	42%	69%		1.46	5.9	6.4	207.00	170.00	0.82		10,583	8,691			13,343	13,351	1,352	10,583	8,691		13,343	13,351	1,352
12/24/2015	TRUE	TRUE	TRUE	3.55	8.80	5.80	61%	40%	66%		1.52	5.9	6.4									13,343	13,351	1,352				13,343	13,351	1,352
12/25/2015	TRUE	TRUE	TRUE	3.47	7.27	4.95	70%	48%	68%	MinAvg	1.47	5.9	6.5									13,343	13,351	1,352				13,343	13,351	1,352
12/26/2015	TRUE	TRUE	FALSE	3.40	7.95	5.22	65%	43%	66%		1.52	5.9	6.3									13,472	13,930	1,352				13,472	13,930	1,352
12/27/2015	TRUE	TRUE	FALSE	3.41	8.13	5.32	64%	42%	65%		1.53	5.9	6.0									13,472	13,930	1,352				13,472	13,930	1,352
12/28/2015	TRUE	TRUE	TRUE	3.46	8.10	5.51	63%	43%	68%		1.47	5.9	5.9									13,472	13,930	1,352				13,472	13,930	1,352
12/29/2015	TRUE	TRUE	FALSE	3.48	7.81	5.46	64%	45%	70%		1.43	5.9	5.7									13,472	13,930	1,352				13,472	13,930	1,352
12/30/2015	TRUE	TRUE	FALSE	3.44	7.66	5.34	64%	45%	70%		1.43	5.9	5.5	287.00	253.00	0.88		12,782	11,268			13,299	13,397	1,352	12,782	11,268		13,299	13,397	1,352
12/31/2015	TRUE	TRUE	FALSE	3.37	8.09	5.45	62%	42%	67%		1.48	5.9	5.4				28.00			1,273		13,299	13,397	1,336			1,273	13,299	13,397	1,336
1/1/2016	TRUE	TRUE	FALSE	3.38	7.38	4.97	68%	46%	67%		1.48	5.9	5.3									13,299	13,397	1,336				13,299	13,397	1,336
1/2/2016	TRUE	TRUE	FALSE	3.37	8.11	5.17	65%	42%	64%		1.57	5.8	5.3									12,986	13,592	1,336				12,986	13,592	1,336
1/3/2016	TRUE	TRUE	FALSE	3.33	8.23	5.46	61%	40%	66%		1.51	5.8	5.3									12,986	13,592	1,271				12,986	13,592	1,271
1/4/2016	TRUE	TRUE	TRUE	3.23	7.65	5.40	60%	42%	71%		1.42	5.8	5.3									12,986	13,592	1,271				12,986	13,592	1,271
1/5/2016	TRUE	TRUE	TRUE	3.50	10.81	7.54	46%	32%	70%		1.43	5.9	5.6									12,986	13,592	1,271				12,986	13,592	1,271
1/6/2016	TRUE	TRUE	TRUE	3.93	11.36	8.40	47%	35%	74%		1.35	6.0	6.0	224.00	183.00	0.82		15,693	12,820			13,663	13,437	1,271	15,693	12,820		13,663	13,437	1,271
1/7/2016	TRUE	TRUE	TRUE	5.10	10.83	8.19	62%	47%	76%		1.32	6.0	6.3				10.84			740		13,663	13,437	1,165			740	13,663	13,437	1,165
1/8/2016	TRUE	TRUE	FALSE	3.86	18.52	6.91	56%	21%	37%	inMaxAvgM	2.68	6.1	6.4									13,663	13,437	1,165				13,663	13,437	1,165
1/9/2016	TRUE	TRUE	TRUE	3.56	10.06	6.42	55%	35%	64%		1.57	6.1	6.7									13,019	14,149	1,165				13,019	14,149	1,165
1/10/2016	TRUE	TRUE	FALSE	3.36	9.34	6.12	55%	36%	66%		1.53	6.1	6.8																	

Date	Butte Break?	CSU Break?	Precip?	Min Influent Flow, mgd	Max Influent Flow, mgd	Avg Influent Flow, mgd	Min % of Avg	Min % of Max	Avg % of Max	Flow Outlier Type	Diurnal Peak Factor (DPF)	30-d Avg of Avg Flow, mgd	7-d Avg of Avg Flow, mgd	Influent TSS Conc., mg/L	Influent BOD Conc., mg/L	BOD/TSS Ratio	Influent NH3-N Conc., mg/L	Avg Inf TSS Load, ppd	Avg Inf BOD Load, ppd	Avg Inf NH3 Load, ppd	Load Outlier Type	30-d Avg of TSS Load, ppd	30-d Avg of BOD Load, ppd	30-d Avg of NH3-N Load, ppd	non-SN TSS Load, ppd	non-SN BOD Load, ppd	non-SN NH3 Load, ppd	30-d Avg of non-SN TSS Load, ppd	30-d Avg of non-SN BOD Load, ppd	30-d Avg of non-SN NH3-N Load, ppd
1/22/2016	TRUE	TRUE	TRUE	4.07	10.58	8.08	50%	38%	76%		1.31	6.6	8.2	204.00	180.00	0.88		13,747	12,130			13,158	11,590	975	13,747	12,130		13,158	11,590	975
1/23/2016	TRUE	TRUE	TRUE	5.66	11.90	8.98	63%	48%	75%		1.33	6.7	8.5									13,802	12,315	975				13,802	12,315	975
1/24/2016	TRUE	TRUE	TRUE	4.33	10.95	8.13	53%	40%	74%		1.35	6.8	8.6									13,802	12,315	975				13,802	12,315	975
1/25/2016	TRUE	TRUE	TRUE	3.88	10.91	7.68	51%	36%	70%		1.42	6.8	8.5									13,802	12,315	975				13,802	12,315	975
1/26/2016	FALSE	FALSE	FALSE	3.79	10.68	7.36	51%	35%	69%		1.45	6.9	8.3									13,802	12,315	975				13,802	12,315	975
1/27/2016	FALSE	FALSE	FALSE	3.56	10.36	6.95	51%	34%	67%		1.49	6.9	8.0	213.00	229.00	1.08		12,346	13,274			13,511	12,507	975	12,346	13,274		13,511	12,507	975
1/28/2016	FALSE	FALSE	TRUE	3.52	9.91	6.80	52%	36%	69%		1.46	7.0	7.7				21.10			1,197		13,511	12,507	1,019			1,197	13,511	12,507	1,019
1/29/2016	FALSE	FALSE	TRUE	3.52	9.57	6.82	52%	37%	71%		1.40	7.0	7.6									13,511	12,507	1,019				13,511	12,507	1,019
1/30/2016	FALSE	FALSE	TRUE	3.65	10.38	7.06	52%	35%	68%		1.47	7.1	7.5									13,693	12,817	1,019				13,693	12,817	1,019
1/31/2016	FALSE	FALSE	TRUE	3.49	10.92	6.92	50%	32%	63%		1.58	7.1	7.2									13,693	12,817	956				13,693	12,817	956
2/1/2016	FALSE	FALSE	FALSE	3.40	10.07	6.75	50%	34%	67%		1.49	7.2	7.0									13,693	12,817	956				13,693	12,817	956
2/2/2016	FALSE	FALSE	FALSE	3.42	9.55	6.53	52%	36%	68%		1.46	7.3	6.9									13,693	12,817	956				13,693	12,817	956
2/3/2016	FALSE	FALSE	FALSE	3.36	9.37	6.40	53%	36%	68%		1.46	7.3	6.8									13,693	12,817	956				13,693	12,817	956
2/4/2016	FALSE	FALSE	FALSE	3.32	9.37	6.31	53%	35%	67%		1.48	7.3	6.7	261.00	302.00	1.16		13,735	15,893			13,702	13,432	956	13,735	15,893		13,702	13,432	956
2/5/2016	FALSE	FALSE	FALSE	3.21	9.18	6.22	52%	35%	68%		1.48	7.3	6.6									13,702	13,432	956				13,702	13,432	956
2/6/2016	FALSE	FALSE	FALSE	3.24	9.60	6.05	54%	34%	63%		1.59	7.2	6.5									13,204	13,585	956				13,204	13,585	956
2/7/2016	FALSE	FALSE	FALSE	3.23	10.03	5.92	55%	32%	59%		1.69	7.1	6.4									13,204	13,585	1,027				13,204	13,585	1,027
2/8/2016	FALSE	FALSE	FALSE	3.16	8.94	6.02	52%	35%	67%		1.49	7.1	6.3									13,204	13,585	1,027				13,204	13,585	1,027
2/9/2016	FALSE	FALSE	FALSE	3.20	8.88	6.04	53%	36%	68%		1.47	7.1	6.2									13,204	13,585	1,027				13,204	13,585	1,027
2/10/2016	FALSE	FALSE	FALSE	3.20	8.73	5.92	54%	37%	68%		1.47	7.1	6.1	226.00	141.00	0.62		11,158	6,962			12,795	12,260	1,027	11,158	6,962		12,795	12,260	1,027
2/11/2016	FALSE	FALSE	FALSE	3.19	8.79	5.85	55%	36%	67%		1.50	7.0	6.0									12,795	12,260	1,027				12,795	12,260	1,027
2/12/2016	FALSE	FALSE	FALSE	3.20	8.95	5.89	54%	36%	66%		1.52	7.0	6.0									12,795	12,260	1,027				12,795	12,260	1,027
2/13/2016	FALSE	FALSE	FALSE	3.16	9.27	5.66	56%	34%	61%		1.64	7.0	5.9									12,747	12,064	1,027				12,747	12,064	1,027
2/14/2016	FALSE	FALSE	FALSE	3.12	8.97	5.56	56%	35%	62%		1.61	7.0	5.9									12,747	12,064	1,108				12,747	12,064	1,108
2/15/2016	FALSE	FALSE	FALSE	3.11	8.88	5.79	54%	35%	65%		1.53	6.9	5.8									12,747	12,064	1,108				12,747	12,064	1,108
2/16/2016	FALSE	FALSE	FALSE	3.17	8.58	5.76	55%	37%	67%		1.49	6.9	5.8									12,747	12,064	1,108				12,747	12,064	1,108
2/17/2016	FALSE	FALSE	TRUE	3.14	9.51	5.89	53%	33%	62%		1.61	6.8	5.8	274.00	327.00	1.19		13,460	16,063			12,889	12,864	1,108	13,460	16,063		12,889	12,864	1,108
2/18/2016	FALSE	FALSE	TRUE	3.25	9.42	6.14	53%	35%	65%		1.53	6.8	5.8									12,889	12,864	1,108				12,889	12,864	1,108
2/19/2016	FALSE	FALSE	TRUE	3.24	8.65	6.08	53%	37%	70%		1.42	6.6	5.8									12,889	12,864	1,108				12,889	12,864	1,108
2/20/2016	FALSE	FALSE	FALSE	3.22	9.60	5.96	54%	34%	62%		1.61	6.6	5.9									12,889	12,864	1,108				12,889	12,864	1,108
2/21/2016	FALSE	FALSE	FALSE	3.16	9.40	5.93	53%	34%	63%		1.59	6.5	5.9									12,889	12,864	1,197				12,889	12,864	1,197
2/22/2016	FALSE	FALSE	FALSE	3.17	8.79	5.94	53%	36%	68%		1.48	6.4	5.9									12,675	13,048	1,197				12,675	13,048	1,197
2/23/2016	FALSE	FALSE	FALSE	3.25	9.01	5.94	55%	36%	66%		1.52	6.3	6.0									12,675	13,048	1,197				12,675	13,048	1,197
2/24/2016	FALSE	FALSE	FALSE	3.23	9.09	5.92	55%	36%	65%		1.54	6.3	6.0	236.00	194.00	0.82		11,652	9,578			12,470	12,354	1,197	11,652	9,578		12,470	12,354	1,197
2/25/2016	FALSE	FALSE	FALSE	3.21	8.60	5.81	55%	37%	68%		1.48	6.2	6.0									12,470	12,354	1,197				12,470	12,354	1,197
2/26/2016	FALSE	FALSE	FALSE	3.16	8.51	5.75	55%	37%	68%		1.48	6.1	5.9									12,470	12,354	1,197				12,470	12,354	1,197
2/27/2016	FALSE	FALSE	FALSE	3.12	9.20	5.71	55%	34%	62%		1.61	6.1	5.9									12,501	12,124	1,197				12,501	12,124	1,197
2/28/2016	FALSE	FALSE	FALSE	3.12	9.00	5.70	55%	35%	63%		1.58	6.1	5.8									12,501	12,124					12,501	12,124	
2/29/2016	FALSE	FALSE	FALSE	3.09	8.69	5.74	54%	36%	66%		1.51	6.0	5.8									12,501	12,124					12,501	12,124	
3/1/2016	FALSE	FALSE	FALSE	3.14	8.33	5.68	55%	38%	68%		1.47	6.0	5.8									12,501	12,124					12,501	12,124	
3/2/2016	FALSE	FALSE	FALSE	3.13	8.55	5.76	54%	37%	67%		1.48	6.0	5.8	319.00	239.00	0.75		15,324	11,481			13,066	11,995		15,324	11,481		13,066	11,995	
3/3/2016	FALSE	FALSE	TRUE	3.16	8.44	5.77	55%	37%	68%		1.46	5.9	5.7				29.00			1,396		13,066	11,995	1,396			1,396	13,066	11,995	1,396
3/4/2016	FALSE	FALSE	TRUE	3.16	8.39	5.82	54%	38%	69%		1.44	5.9	5.7									13,066	11,995	1,396				13,066	11,995	1,396
3/5/2016	FALSE	FALSE	TRUE	3.27	10.68	6.61	49%	31%	62%		1.62	5.9	5.8									13,066	11,995	1,396				13,066	11,995	1,396
3/6/2016	FALSE	FALSE	TRUE	5.25	11.84	9.16	57%	44%	77%		1.29	6.0	6.3									12,899	11,021	1,396				12,899	11,021	1,396
3/7/2016	FALSE	FALSE	TRUE	8.80	16.65	12.75	69%	53%	77%		1.31	6.2	7.2									12,899	11,021	1,396				12,899	11,021	1,396
3/8/2016	FALSE	FALSE	FALSE	6.20	13.27	9.82	63%	47%	74%		1.35	6.3	7.7									12,899	11,021	1,396				12,899	11,021	1,396
3/9/2016	FALSE	FALSE	TRUE	4.84	11.50	8.55	57%	42%	74%		1.35	6.4	8.0									12,899	11,021	1,396				12,899	11,021	1,396
3/10/2016	FALSE	FALSE	TRUE	4.39	15.06	10.17	43%	29%	68%		1.48	6.6	8.6				26.40			2,239	NH3	12,899	11,021	1,396			2,239	12,899	11,021	1,396
3/11/2016	FALSE	TRUE	TRUE	9.01	16.18	12.91	70%	56%	80%	inAvgMinM	1.25	6.6	9.0									12,899	11,021	1,396				12,899	11,021	1,396
3/12/2016	FALSE	TRUE	TRUE	6.93	13.88	11.14	62%	50%	80%		1.25	6.7	9.7									13,479	12,374	1,396				13,479	12,374	1,396
3/13/2016	FALSE	TRUE	TRUE	7.59	13.37	10.72	71%	57%	80%	inAvgMinM	1.25	6.8	10.3									13,479	12,374	1,396				13,479	12,374	1,396
3/14/2016	FALSE	TRUE	FALSE	6.41	12.20	9.73	66%																							

Date	Butte Break?	CSU Break?	Precip?	Min Influent Flow, mgd	Max Influent Flow, mgd	Avg Influent Flow, mgd	Min % of Avg	Min % of Max	Avg % of Max	Flow Outlier Type	Diurnal Peak Factor (DPF)	30-d Avg of Avg Flow, mgd	7-d Avg of Avg Flow, mgd	Influent TSS Conc., mg/L	Influent BOD Conc., mg/L	BOD/TSS Ratio	Influent NH3-N Conc., mg/L	Avg Inf TSS Load, ppd	Avg Inf BOD Load, ppd	Avg Inf NH3 Load, ppd	Load Outlier Type	30-d Avg of TSS Load, ppd	30-d Avg of BOD Load, ppd	30-d Avg of NH3-N Load, ppd	non-SN TSS Load, ppd	non-SN BOD Load, ppd	non-SN NH3 Load, ppd	30-d Avg of non-SN TSS Load, ppd	30-d Avg of non-SN BOD Load, ppd	30-d Avg of non-SN NH3-N Load, ppd
3/25/2016	TRUE	FALSE	FALSE	3.46	9.87	6.69	52%	35%	68%		1.48	7.4	7.0									12,814	10,673	1,338				12,753	10,658	1,338
3/26/2016	FALSE	FALSE	FALSE	3.36	9.92	6.39	53%	34%	64%		1.55	7.5	6.9									13,202	11,038	1,338				13,120	11,018	1,338
3/27/2016	FALSE	FALSE	FALSE	3.36	9.61	6.09	55%	35%	63%		1.58	7.5	6.8									13,202	11,038	1,338				13,120	11,018	1,338
3/28/2016	FALSE	FALSE	FALSE	3.27	9.84	6.36	51%	33%	65%		1.55	7.5	6.7									13,202	11,038	1,338				13,120	11,018	1,338
3/29/2016	FALSE	FALSE	FALSE	3.35	9.37	6.28	53%	36%	67%		1.49	7.5	6.6									13,202	11,038	1,338				13,120	11,018	1,338
3/30/2016	FALSE	FALSE	FALSE	3.27	9.22	6.20	53%	35%	67%		1.49	7.5	6.5	256.00	316.00	1.23		13,237	16,340			13,211	12,364	1,338	13,237	16,340		13,150	12,349	1,338
3/31/2016	FALSE	FALSE	FALSE	3.36	9.23	6.14	55%	36%	67%		1.50	7.5	6.4		29.90					1,531		13,211	12,364	1,387			1,531	13,150	12,349	1,387
4/1/2016	FALSE	FALSE	FALSE	3.26	9.08	6.07	54%	36%	67%		1.50	7.6	6.3									13,211	12,364	1,387				13,150	12,349	1,387
4/2/2016	FALSE	FALSE	FALSE	3.23	8.93	5.83	55%	36%	65%		1.53	7.6	6.2									12,506	12,658	1,387				12,425	12,638	1,387
4/3/2016	FALSE	FALSE	FALSE	3.26	9.21	5.87	56%	35%	64%		1.57	7.6	6.1									12,506	12,658	1,384				12,425	12,638	1,384
4/4/2016	FALSE	FALSE	FALSE	3.22	8.88	6.03	53%	36%	68%		1.47	7.6	6.1									12,506	12,658	1,384				12,425	12,638	1,384
4/5/2016	FALSE	FALSE	FALSE	3.16	8.77	6.00	53%	36%	68%		1.46	7.5	6.1									12,506	12,658	1,384				12,425	12,638	1,384
4/6/2016	FALSE	FALSE	FALSE	3.39	8.76	5.99	57%	39%	68%		1.46	7.4	6.0	248.00	179.00	0.72		12,389	8,942			12,477	11,729	1,384	12,389	8,942		12,416	11,714	1,384
4/7/2016	FALSE	FALSE	FALSE	3.40	8.85	6.01	57%	38%	68%		1.47	7.2	6.0				28.30			1,418		12,477	11,729	1,392			1,418	12,416	11,714	1,392
4/8/2016	FALSE	FALSE	FALSE	3.41	8.79	5.99	57%	39%	68%		1.47	7.1	6.0									12,477	11,729	1,392				12,416	11,714	1,392
4/9/2016	FALSE	FALSE	TRUE	3.35	9.08	5.97	56%	37%	66%		1.52	7.0	6.0									12,477	11,729	1,392				12,416	11,714	1,392
4/10/2016	FALSE	FALSE	TRUE	3.36	9.26	5.98	56%	36%	65%		1.55	6.8	6.0									12,477	11,729	1,392				12,416	11,714	1,392
4/11/2016	FALSE	FALSE	FALSE	3.36	8.39	5.94	57%	40%	71%		1.41	6.8	6.0									12,477	11,729	1,392				12,416	11,714	1,392
4/12/2016	FALSE	FALSE	FALSE	3.43	8.58	5.94	58%	40%	69%		1.44	6.6	6.0									12,477	11,729	1,392				12,416	11,714	1,392
4/13/2016	FALSE	FALSE	FALSE	3.38	8.39	5.94	57%	40%	71%		1.41	6.6	6.0	277.00	217.00	0.78		13,722	10,750			12,726	11,533	1,392	13,722	10,750		12,677	11,521	1,392
4/14/2016	FALSE	FALSE	FALSE	3.41	8.69	6.00	57%	39%	69%		1.45	6.5	6.0				31.80			1,591		12,726	11,533	1,432			1,591	12,677	11,521	1,432
4/15/2016	FALSE	FALSE	FALSE	3.32	8.45	5.88	56%	39%	70%		1.44	6.4	6.0									12,726	11,533	1,432				12,677	11,521	1,432
4/16/2016	FALSE	FALSE	FALSE	3.34	8.79	5.70	59%	38%	65%		1.54	6.3	5.9									13,018	11,791	1,432				12,957	11,776	1,432
4/17/2016	FALSE	FALSE	FALSE	3.40	8.63	5.68	60%	39%	66%		1.52	6.2	5.9									13,018	11,791	1,533				12,957	11,776	1,533
4/18/2016	FALSE	FALSE	FALSE	3.39	8.49	5.87	58%	40%	69%		1.45	6.2	5.9									13,018	11,791	1,533				12,957	11,776	1,533
4/19/2016	FALSE	FALSE	FALSE	3.40	8.36	5.87	58%	41%	70%		1.42	6.2	5.9									13,018	11,791	1,533				12,957	11,776	1,533
4/20/2016	FALSE	FALSE	FALSE	3.40	8.56	5.87	58%	40%	69%		1.46	6.2	5.9	316.00				15,470				13,508	11,791	1,533	15,470			13,459	11,776	1,533
4/21/2016	FALSE	FALSE	FALSE	3.46	8.38	5.99	58%	41%	71%		1.40	6.1	5.9				35.20			1,758		13,508	11,791	1,578			1,758	13,459	11,776	1,578
4/22/2016	FALSE	FALSE	TRUE	3.58	9.49	6.40	56%	38%	67%		1.48	6.1	5.9									13,508	11,791	1,578				13,459	11,776	1,578
4/23/2016	FALSE	FALSE	FALSE	3.48	9.07	6.05	58%	38%	67%		1.50	6.1	5.9									13,508	11,791	1,575				13,459	11,776	1,575
4/24/2016	FALSE	FALSE	FALSE	3.49	8.86	5.95	59%	39%	67%		1.49	6.0	6.0									13,705	12,011	1,575				13,705	12,011	1,575
4/25/2016	FALSE	FALSE	FALSE	3.38	8.62	5.99	56%	39%	69%		1.44	6.0	6.0									13,705	12,011	1,575				13,705	12,011	1,575
4/26/2016	FALSE	FALSE	FALSE	3.43	8.72	6.01	57%	39%	69%		1.45	6.0	6.0									13,705	12,011	1,575				13,705	12,011	1,575
4/27/2016	FALSE	FALSE	FALSE	3.44	8.61	6.04	57%	40%	70%		1.43	6.0	6.0	261.00	189.00	0.72		13,148	9,521			13,593	11,388	1,575	13,148	9,521		13,593	11,388	1,575
4/28/2016	FALSE	FALSE	FALSE	3.41	8.53	5.98	57%	40%	70%		1.43	6.0	6.1									13,593	11,388	1,575				13,593	11,388	1,575
4/29/2016	FALSE	FALSE	FALSE	3.46	8.51	5.93	58%	41%	70%		1.44	6.0	6.0									13,593	11,388	1,575				13,593	11,388	1,575
4/30/2016	FALSE	FALSE	FALSE	3.46	8.70	5.76	60%	40%	66%		1.51	6.0	6.0									13,682	9,738	1,575				13,682	9,738	1,575
5/1/2016	FALSE	FALSE	TRUE	3.42	8.52	5.70	60%	40%	67%		1.49	5.9	5.9									13,682	9,738	1,589				13,682	9,738	1,589
5/2/2016	FALSE	FALSE	TRUE	3.36	8.36	5.85	57%	40%	70%		1.43	5.9	5.9									13,682	9,738	1,589				13,682	9,738	1,589
5/3/2016	FALSE	FALSE	FALSE	3.41	8.37	5.86	58%	41%	70%		1.43	5.9	5.9									13,682	9,738	1,589				13,682	9,738	1,589
5/4/2016	FALSE	FALSE	FALSE	3.44	8.44	5.90	58%	41%	70%		1.43	5.9	5.9	252.00	195.00	0.77		12,400	9,595			13,426	9,702	1,589	12,400	9,595		13,426	9,702	1,589
5/5/2016	FALSE	FALSE	TRUE	3.41	8.66	6.19	55%	39%	71%		1.40	5.9	5.9				32.30			1,667		13,426	9,702	1,609			1,667	13,426	9,702	1,609
5/6/2016	FALSE	FALSE	TRUE	3.43	8.26	5.92	58%	42%	72%		1.40	5.9	5.9									13,426	9,702	1,609				13,426	9,702	1,609
5/7/2016	FALSE	FALSE	TRUE	3.43	9.39	5.88	58%	37%	63%		1.60	5.9	5.9									13,685	9,955	1,609				13,685	9,955	1,609
5/8/2016	FALSE	FALSE	TRUE	3.36	8.92	5.73	59%	38%	64%		1.56	5.9	5.9									13,685	9,955	1,672				13,685	9,955	1,672
5/9/2016	FALSE	FALSE	FALSE	3.41	8.39	5.99	57%	41%	71%		1.40	5.9	5.9									13,685	9,955	1,672				13,685	9,955	1,672
5/10/2016	FALSE	FALSE	FALSE	3.44	8.35	5.89	58%	41%	71%		1.42	5.9	5.9									13,685	9,955	1,672				13,685	9,955	1,672
5/11/2016	FALSE	FALSE	FALSE	3.51	8.28	5.83	60%	42%	70%		1.42	5.9	5.9	202.20	203.00	1.00		9,831	9,870			12,914	9,934	1,672	9,831	9,870		12,914	9,934	1,672
5/12/2016	FALSE	FALSE	FALSE	3.42	8.37	5.81	59%	41%	69%		1.44	5.9	5.9									12,914	9,934	1,672				12,914	9,934	1,672
5/13/2016	FALSE	FALSE	FALSE	3.43	8.81	5.83	59%	39%	66%		1.51	5.9	5.9									12,914	9,934	1,672				12,914	9,934	1,672
5/14/2016	FALSE	FALSE	FALSE	3.34	8.57	5.66	59%	39%	66%		1.51	5.9	5.8									12,712	9,662	1,672				12,712	9,662	1,672
5/15/2016	FALSE	FALSE	FALSE	3.33	8.82	5.67	59%	38%	64%		1.56	5.9	5.8									12,712	9,662	1,713				12,712	9,662	1,713
5/16/2016	FALSE	FALSE	FALSE	3																										

Date	Butte Break?	CSU Break?	Precip?	Min Influent Flow, mgd	Max Influent Flow, mgd	Avg Influent Flow, mgd	Min % of Avg	Min % of Max	Avg % of Max	Flow Outlier Type	Diurnal Peak Factor (DPF)	30-d Avg of Avg Flow, mgd	7-d Avg of Avg Flow, mgd	Influent TSS Conc., mg/L	Influent BOD Conc., mg/L	BOD/TSS Ratio	Influent NH3-N Conc., mg/L	Avg Inf TSS Load, ppd	Avg Inf BOD Load, ppd	Avg Inf NH3 Load, ppd	Load Outlier Type	30-d Avg of TSS Load, ppd	30-d Avg of BOD Load, ppd	30-d Avg of NH3-N Load, ppd	non-SN TSS Load, ppd	non-SN BOD Load, ppd	non-SN NH3 Load, ppd	30-d Avg of non-SN TSS Load, ppd	30-d Avg of non-SN BOD Load, ppd	30-d Avg of non-SN NH3-N Load, ppd
5/27/2016	TRUE	TRUE	FALSE	3.48	7.75	5.44	64%	45%	70%		1.42	5.8	5.6	315.00	237.00	0.75		14,291	10,753			12,847	9,935	1,667	14,291	10,753		12,847	9,935	1,667
5/28/2016	TRUE	TRUE	FALSE	3.41	7.91	5.18	66%	43%	65%		1.53	5.8	5.5									12,771	10,073	1,667				12,771	10,073	1,667
5/29/2016	TRUE	TRUE	FALSE	3.47	7.48	5.03	69%	46%	67%		1.49	5.7	5.4									12,771	10,073	1,667				12,771	10,073	1,667
5/30/2016	TRUE	TRUE	FALSE	3.43	8.02	5.21	66%	43%	65%		1.54	5.7	5.4									12,771	10,073	1,667				12,771	10,073	1,667
5/31/2016	TRUE	TRUE	FALSE	3.45	7.54	5.33	65%	46%	71%		1.41	5.7	5.3									12,771	10,073	1,667				12,771	10,073	1,667
6/1/2016	TRUE	TRUE	FALSE	3.53	7.37	5.36	66%	48%	73%		1.38	5.7	5.3	356.85	186.00	0.52		15,952	8,315			13,408	9,633	1,667	15,952	8,315		13,408	9,633	1,667
6/2/2016	TRUE	TRUE	FALSE	3.46	7.58	5.40	64%	46%	71%		1.40	5.7	5.3				30.00			1,351		13,408	9,633	1,509			1,351	13,408	9,633	1,509
6/3/2016	TRUE	TRUE	FALSE	3.50	7.28	5.37	65%	48%	74%		1.36	5.7	5.3									13,408	9,633	1,509				13,408	9,633	1,509
6/4/2016	TRUE	TRUE	FALSE	3.50	8.04	5.31	66%	44%	66%		1.51	5.6	5.3									13,659	9,646	1,509				13,659	9,646	1,509
6/5/2016	TRUE	TRUE	FALSE	3.48	7.70	5.21	67%	45%	68%		1.48	5.6	5.3									13,659	9,646	1,351				13,659	9,646	1,351
6/6/2016	TRUE	TRUE	FALSE	3.44	7.24	5.31	65%	48%	73%		1.36	5.6	5.3									13,659	9,646	1,351				13,659	9,646	1,351
6/7/2016	TRUE	TRUE	FALSE	3.51	7.48	5.33	66%	47%	71%		1.40	5.6	5.3									13,659	9,646	1,351				13,659	9,646	1,351
6/8/2016	TRUE	TRUE	FALSE	3.50	7.62	5.38	65%	46%	71%		1.42	5.6	5.3	134.70	97.00	0.72		6,044	4,352			12,136	8,322	1,351	6,044	4,352		12,136	8,322	1,351
6/9/2016	TRUE	TRUE	FALSE	3.48	7.31	5.32	65%	48%	73%		1.37	5.5	5.3									12,136	8,322	1,351				12,136	8,322	1,351
6/10/2016	TRUE	TRUE	FALSE	3.40	7.61	5.29	64%	45%	70%		1.44	5.5	5.3	289.00	229.00	0.79		12,750	10,103			12,239	8,679	1,351	12,750	10,103		12,239	8,679	1,351
6/11/2016	TRUE	TRUE	FALSE	3.41	7.73	5.10	67%	44%	66%		1.52	5.5	5.3									12,720	8,381	1,351				12,720	8,381	1,351
6/12/2016	TRUE	TRUE	FALSE	3.42	7.74	5.09	67%	44%	66%		1.52	5.5	5.3									12,720	8,381	1,351				12,720	8,381	1,351
6/13/2016	TRUE	TRUE	FALSE	3.43	7.42	5.33	64%	46%	72%		1.39	5.5	5.3									12,720	8,381	1,351				12,720	8,381	1,351
6/14/2016	TRUE	TRUE	FALSE	3.44	7.10	5.28	65%	48%	74%		1.34	5.4	5.3									12,720	8,381	1,351				12,720	8,381	1,351
6/15/2016	TRUE	TRUE	FALSE	3.44	7.43	5.42	63%	46%	73%		1.37	5.4	5.3	280.40	246.00	0.88		12,675	11,120			12,713	8,929	1,351	12,675	11,120		12,713	8,929	1,351
6/16/2016	TRUE	TRUE	FALSE	3.45	7.35	5.37	64%	47%	73%		1.37	5.4	5.3									12,713	8,929	1,351				12,713	8,929	1,351
6/17/2016	TRUE	TRUE	TRUE	3.41	7.59	5.38	63%	45%	71%		1.41	5.4	5.3	278.20	247.00	0.89		12,483	11,083			12,680	9,288	1,351	12,483	11,083		12,680	9,288	1,351
6/18/2016	TRUE	TRUE	TRUE	3.53	8.01	5.29	67%	44%	66%		1.51	5.4	5.3									12,366	9,288	1,351				12,366	9,288	1,351
6/19/2016	TRUE	TRUE	FALSE	3.40	7.51	5.05	67%	45%	67%		1.49	5.4	5.3									12,366	9,288	1,351				12,366	9,288	1,351
6/20/2016	TRUE	TRUE	FALSE	3.38	7.23	5.17	65%	47%	72%		1.40	5.3	5.3				30.00			1,294		12,366	9,288	1,322			1,294	12,366	9,288	1,322
6/21/2016	TRUE	TRUE	FALSE	3.44	7.15	5.28	65%	48%	74%		1.35	5.3	5.3									12,366	9,288	1,322				12,366	9,288	1,322
6/22/2016	TRUE	TRUE	FALSE	3.44	7.28	5.28	65%	47%	73%		1.38	5.3	5.3	270.40	201.00	0.74		11,907	8,851			12,300	9,225	1,322	11,907	8,851		12,300	9,225	1,322
6/23/2016	TRUE	TRUE	FALSE	3.36	7.35	5.24	64%	46%	71%		1.40	5.3	5.3									12,300	9,225	1,322				12,300	9,225	1,322
6/24/2016	TRUE	TRUE	FALSE	3.44	7.24	5.25	66%	48%	73%		1.38	5.3	5.2	348.60	310.00	0.89		15,263	13,573			12,671	9,769	1,322	15,263	13,573		12,671	9,769	1,322
6/25/2016	TRUE	TRUE	FALSE	3.45	7.30	5.02	69%	47%	69%		1.45	5.3	5.2									12,671	9,769	1,322				12,671	9,769	1,322
6/26/2016	TRUE	TRUE	FALSE	3.42	7.35	5.03	68%	47%	68%		1.46	5.3	5.2									12,671	9,769	1,322				12,671	9,769	1,322
6/27/2016	TRUE	TRUE	FALSE	3.44	7.41	5.26	65%	46%	71%		1.41	5.3	5.2									12,439	9,628	1,322				12,439	9,628	1,322
6/28/2016	TRUE	TRUE	FALSE	3.53	7.36	5.25	67%	48%	71%		1.40	5.3	5.2									12,439	9,628	1,322				12,439	9,628	1,322
6/29/2016	TRUE	TRUE	FALSE	3.43	7.18	5.29	65%	48%	74%		1.36	5.3	5.2									12,439	9,628	1,322				12,439	9,628	1,322
6/30/2016	TRUE	TRUE	FALSE	3.52	7.02	5.23	67%	50%	75%		1.34	5.3	5.2	284.40	184.00	0.65		12,405	8,026			12,435	9,428	1,322	12,405	8,026		12,435	9,428	1,322
7/1/2016	TRUE	TRUE	FALSE	3.45	7.41	5.21	66%	47%	70%		1.42	5.3	5.2	262.60	216.00	0.82		11,410	9,386			12,321	9,423	1,322	11,410	9,386		12,321	9,423	1,322
7/2/2016	TRUE	TRUE	FALSE	3.44	7.02	4.94	70%	49%	70%	MinAvg	1.42	5.3	5.2									11,867	9,562	1,322				11,867	9,562	1,322
7/3/2016	TRUE	TRUE	FALSE	1.34	6.87	4.75	28%	20%	69%	inAvgMinM	1.45	5.3	5.2									11,867	9,562	1,294				11,867	9,562	1,294
7/4/2016	TRUE	TRUE	FALSE	3.42	7.26	4.86	70%	47%	67%	MinAvg	1.49	5.2	5.2									11,867	9,562	1,294				11,867	9,562	1,294
7/5/2016	TRUE	TRUE	FALSE	3.44	7.43	5.18	66%	46%	70%		1.43	5.2	5.2									11,867	9,562	1,294				11,867	9,562	1,294
7/6/2016	TRUE	TRUE	FALSE	3.47	7.21	4.90	71%	48%	68%	MinAvg	1.47	5.2	5.2	293.00	201.00	0.69		11,974	8,214			11,879	9,412	1,294	11,974	8,214		11,879	9,412	1,294
7/7/2016	TRUE	TRUE	FALSE	3.50	7.23	5.67	62%	48%	78%		1.28	5.3	5.3									11,879	9,412	1,294				11,879	9,412	1,294
7/8/2016	TRUE	TRUE	FALSE	3.42	7.66	5.34	64%	45%	70%		1.43	5.3	5.4									11,879	9,412	1,294				11,879	9,412	1,294
7/9/2016	TRUE	TRUE	FALSE	3.42	7.68	5.16	66%	45%	67%		1.49	5.3	5.3									12,608	10,044	1,294				12,608	10,044	1,294
7/10/2016	TRUE	TRUE	FALSE	3.37	7.61	5.09	66%	44%	67%		1.50	5.2	5.3									12,608	10,044	1,294				12,608	10,044	1,294
7/11/2016	TRUE	TRUE	FALSE	3.33	7.24	5.22	64%	46%	72%		1.39	5.2	5.3									12,588	10,036	1,294				12,588	10,036	1,294
7/12/2016	TRUE	TRUE	FALSE	3.39	7.54	5.30	64%	45%	70%		1.42	5.2	5.3									12,588	10,036	1,294				12,588	10,036	1,294
7/13/2016	TRUE	TRUE	FALSE	3.40	7.15	5.29	64%	48%	74%		1.35	5.3	5.3									12,588	10,036	1,294				12,588	10,036	1,294
7/14/2016	TRUE	TRUE	FALSE	3.45	7.30	5.30	65%	47%	73%		1.38	5.3	5.3									12,588	10,036	1,294				12,588	10,036	1,294
7/15/2016	TRUE	TRUE	FALSE	3.39	7.24	5.25	65%	47%	73%		1.38	5.3	5.2	275.60	205.00	0.74		12,067	8,976			12,523	9,904	1,294	12,067	8,976		12,523	9,904	1,294
7/16/2016	TRUE	TRUE	FALSE	3.37	7.28	5.06	67%	46%	70%		1.44	5.2	5.2									12,501	9,730	1,294				12,501	9,730	1,294
7/17/2016	TRUE	TRUE	FALSE	3.38	7.30	5.10	66%	46%	70%		1.43																			

Date	Butte Break?	CSU Break?	Precip?	Min Influent Flow, mgd	Max Influent Flow, mgd	Avg Influent Flow, mgd	Min % of Avg	Min % of Max	Avg % of Max	Flow Outlier Type	Diurnal Peak Factor (DPF)	30-d Avg of Avg Flow, mgd	7-d Avg of Avg Flow, mgd	Influent TSS Conc., mg/L	Influent BOD Conc., mg/L	BOD/TSS Ratio	Influent NH3-N Conc., mg/L	Avg Inf TSS Load, ppd	Avg Inf BOD Load, ppd	Avg Inf NH3 Load, ppd	Load Outlier Type	30-d Avg of TSS Load, ppd	30-d Avg of BOD Load, ppd	30-d Avg of NH3-N Load, ppd	non-SN TSS Load, ppd	non-SN BOD Load, ppd	non-SN NH3 Load, ppd	30-d Avg of non-SN TSS Load, ppd	30-d Avg of non-SN BOD Load, ppd	30-d Avg of non-SN NH3-N Load, ppd
7/29/2016	TRUE	TRUE	FALSE	3.46	7.53	5.25	66%	46%	70%		1.43	5.2	5.2	250.00	177.00	0.71		10,946	7,750			11,642	8,466		10,946	7,750		11,642	8,466	
7/30/2016	TRUE	TRUE	FALSE	3.51	7.26	5.07	69%	48%	70%		1.43	5.2	5.2									11,642	8,466					11,642	8,466	
7/31/2016	TRUE	TRUE	FALSE	3.44	7.36	5.06	68%	47%	69%		1.45	5.2	5.2									11,533	8,540					11,533	8,540	
8/1/2016	TRUE	TRUE	FALSE	3.46	7.51	5.28	66%	46%	70%		1.42	5.2	5.2									11,554	8,370					11,554	8,370	
8/2/2016	TRUE	TRUE	FALSE	3.47	7.14	5.25	66%	49%	74%		1.36	5.2	5.2									11,554	8,370					11,554	8,370	
8/3/2016	TRUE	TRUE	FALSE	3.46	7.39	5.34	65%	47%	72%		1.38	5.2	5.2									11,554	8,370					11,554	8,370	
8/4/2016	TRUE	TRUE	FALSE	3.55	7.21	5.32	67%	49%	74%		1.36	5.2	5.2	288.00	173.00	0.60		12,778	7,676			11,729	8,255		12,778	7,676		11,729	8,255	
8/5/2016	TRUE	TRUE	FALSE	3.41	7.54	5.28	65%	45%	70%		1.43	5.2	5.2	264.20	170.00	0.64		11,634	7,486			11,717	8,145		11,634	7,486		11,717	8,145	
8/6/2016	TRUE	TRUE	FALSE	3.45	7.47	5.15	67%	46%	69%		1.45	5.2	5.2									11,680	8,133					11,680	8,133	
8/7/2016	TRUE	TRUE	FALSE	3.41	7.70	5.21	65%	44%	68%		1.48	5.2	5.2									11,680	8,133					11,680	8,133	
8/8/2016	TRUE	TRUE	FALSE	3.46	7.57	5.35	65%	46%	71%		1.41	5.2	5.3									11,680	8,133					11,680	8,133	
8/9/2016	TRUE	TRUE	FALSE	3.51	7.48	5.41	65%	47%	72%		1.38	5.2	5.3									11,680	8,133					11,680	8,133	
8/10/2016	TRUE	TRUE	FALSE	3.46	7.55	5.49	63%	46%	73%		1.38	5.2	5.3	246.20	123.00	0.50		11,273	5,632			11,629	7,776		11,273	5,632		11,629	7,776	
8/11/2016	TRUE	TRUE	FALSE	3.48	7.59	5.41	64%	46%	71%		1.40	5.2	5.3									11,629	7,776					11,629	7,776	
8/12/2016	TRUE	TRUE	FALSE	3.33	7.94	5.42	61%	42%	68%		1.46	5.3	5.3									11,629	7,776					11,629	7,776	
8/13/2016	TRUE	TRUE	FALSE	3.47	8.15	5.29	66%	43%	65%		1.54	5.3	5.3									11,629	7,776					11,629	7,776	
8/14/2016	TRUE	TRUE	FALSE	3.41	7.90	5.28	65%	43%	67%		1.50	5.3	5.4									11,629	7,776					11,629	7,776	
8/15/2016	TRUE	TRUE	FALSE	3.44	13.15	5.59	62%	26%	43%	AvgMax	2.35	5.3	5.4									11,567	7,576					11,567	7,576	
8/16/2016	TRUE	TRUE	FALSE	3.42	7.89	5.66	60%	43%	72%		1.39	5.3	5.4									11,567	7,576					11,567	7,576	
8/17/2016	TRUE	TRUE	FALSE	3.47	8.07	5.68	61%	43%	70%		1.42	5.3	5.5	285.00	190.00	0.67		13,501	9,001			11,809	7,780		13,501	9,001		11,809	7,780	
8/18/2016	TRUE	TRUE	FALSE	3.47	8.47	5.74	60%	41%	68%		1.48	5.3	5.5				28.90			1,383		11,809	7,780	1,383			1,383	11,809	7,780	1,383
8/19/2016	TRUE	TRUE	FALSE	3.44	7.99	5.76	60%	43%	72%		1.39	5.3	5.5	255.00	167.00	0.65		12,250	8,022			11,858	7,810	1,383	12,250	8,022	1,383	11,858	7,810	1,383
8/20/2016	TRUE	TRUE	FALSE	3.46	8.87	5.73	60%	39%	65%		1.55	5.3	5.6									11,842	7,810	1,383				11,842	7,810	1,383
8/21/2016	TRUE	TRUE	FALSE	3.45	9.10	5.85	59%	38%	64%		1.56	5.4	5.7									11,842	7,810	1,383				11,842	7,810	1,383
8/22/2016	TRUE	TRUE	FALSE	3.45	8.79	5.82	59%	39%	66%		1.51	5.4	5.7									11,974	7,787	1,383				11,974	7,787	1,383
8/23/2016	FALSE	FALSE	FALSE	3.45	8.61	5.81	59%	40%	67%		1.48	5.4	5.8									11,974	7,787	1,383				11,974	7,787	1,383
8/24/2016	FALSE	FALSE	FALSE	3.43	8.68	5.87	58%	40%	68%		1.48	5.4	5.8	265.00				12,973				12,099	7,787	1,383	12,973			12,099	7,787	1,383
8/25/2016	FALSE	FALSE	FALSE	3.49	8.72	5.82	60%	40%	67%		1.50	5.4	5.8									12,099	7,787	1,383				12,099	7,787	1,383
8/26/2016	FALSE	FALSE	FALSE	3.50	8.41	5.87	60%	42%	70%		1.43	5.5	5.8	232.00	211.00	0.91		11,358	10,330			12,016	8,105	1,383	11,358	10,330		12,016	8,105	1,383
8/27/2016	FALSE	FALSE	FALSE	3.49	9.03	5.72	61%	39%	63%		1.58	5.5	5.8									12,089	7,985	1,383				12,089	7,985	1,383
8/28/2016	FALSE	FALSE	FALSE	3.39	8.97	5.81	58%	38%	65%		1.54	5.5	5.8									12,089	7,985	1,383				12,089	7,985	1,383
8/29/2016	FALSE	FALSE	FALSE	3.48	8.79	5.94	59%	40%	68%		1.48	5.5	5.8									12,252	8,024	1,383				12,252	8,024	1,383
8/30/2016	FALSE	FALSE	FALSE	3.39	8.58	5.91	57%	40%	69%		1.45	5.6	5.8									12,252	8,024	1,383				12,252	8,024	1,383
8/31/2016	FALSE	FALSE	FALSE	3.44	8.75	5.89	58%	39%	67%		1.49	5.6	5.9									12,252	8,024	1,383				12,252	8,024	1,383
9/1/2016	FALSE	FALSE	FALSE	3.46	9.32	6.02	57%	37%	65%		1.55	5.6	5.9									12,252	8,024	1,383				12,252	8,024	1,383
9/2/2016	FALSE	FALSE	FALSE	3.56	8.52	5.92	60%	42%	69%		1.44	5.6	5.9	258.00	191.00	0.74		12,738	9,430			12,313	8,225	1,383	12,738	9,430		12,313	8,225	1,383
9/3/2016	FALSE	FALSE	FALSE	3.50	8.93	5.64	62%	39%	63%		1.58	5.6	5.9									12,313	8,225	1,383				12,313	8,225	1,383
9/4/2016	FALSE	FALSE	FALSE	3.41	8.88	5.54	62%	38%	62%		1.60	5.6	5.8									12,247	8,317	1,383				12,247	8,317	1,383
9/5/2016	FALSE	FALSE	FALSE	3.46	9.05	5.73	60%	38%	63%		1.58	5.7	5.8									12,349	8,483	1,383				12,349	8,483	1,383
9/6/2016	FALSE	FALSE	FALSE	3.42	8.55	5.93	58%	40%	69%		1.44	5.7	5.8									12,349	8,483	1,383				12,349	8,483	1,383
9/7/2016	FALSE	FALSE	FALSE	3.50	8.76	5.97	59%	40%	68%		1.47	5.7	5.8	253.70				12,632				12,389	8,483	1,383	12,632			12,389	8,483	1,383
9/8/2016	FALSE	FALSE	FALSE	3.52	8.59	5.99	59%	41%	70%		1.43	5.7	5.8									12,389	8,483	1,383				12,389	8,483	1,383
9/9/2016	FALSE	FALSE	FALSE	3.42	8.50	5.99	57%	40%	70%		1.42	5.8	5.8	272.80	174.00	0.64		13,628	8,692			12,544	8,518	1,383	13,628	8,692		12,544	8,518	1,383
9/10/2016	FALSE	FALSE	FALSE	3.55	8.94	5.87	60%	40%	66%		1.52	5.8	5.8									12,726	9,095	1,383				12,726	9,095	1,383
9/11/2016	FALSE	FALSE	FALSE	3.45	8.99	5.85	59%	38%	65%		1.54	5.8	5.9									12,726	9,095	1,383				12,726	9,095	1,383
9/12/2016	FALSE	FALSE	FALSE	3.47	8.51	6.02	58%	41%	71%		1.41	5.8	5.9									12,726	9,095	1,383				12,726	9,095	1,383
9/13/2016	FALSE	FALSE	FALSE	3.53	8.81	6.00	59%	40%	68%		1.47	5.8	6.0									12,726	9,095	1,383				12,726	9,095	1,383
9/14/2016	FALSE	FALSE	FALSE	3.50	8.96	5.94	59%	39%	66%		1.51	5.8	6.0	167.00				8,273				12,169	9,095	1,383	8,273			12,169	9,095	1,383
9/15/2016	FALSE	FALSE	FALSE	3.51	8.76	5.93	59%	40%	68%		1.48	5.8	5.9									12,169	9,095	1,383				12,169	9,095	1,383
9/16/2016	FALSE	FALSE	FALSE	3.51	17.50	5.91	59%	20%	34%	inMaxAvgM	2.96	5.9	5.9	244.60	176.00	0.72		12,056	8,675			12,157	9,025	1,383	12,056	8,675		12,157	9,025	1,383
9/17/2016	FALSE	FALSE	FALSE	3.60	7.95	5.69	63%	45%	72%		1.40	5.9	5.9									11,989	9,030	1,383				11,989	9,030	1,383
9/18/2016	FALSE	FALSE	FALSE	3.51	8.04	5.77	61%	44%	72%		1.39	5.9	5.9									11,989	9,030					11,989	9,030	
9/19/2016	FALSE	FALSE	FALSE	3.54	8.68	5.89	60%	41%	68%		1.47	5.9	5.9									11,951	9,282					11,951	9,28	

Date	Butte Break?	CSU Break?	Precip?	Min Influent Flow, mgd	Max Influent Flow, mgd	Avg Influent Flow, mgd	Min % of Avg	Min % of Max	Avg % of Max	Flow Outlier Type	Diurnal Peak Factor (DPF)	30-d Avg of Avg Flow, mgd	7-d Avg of Avg Flow, mgd	Influent TSS Conc., mg/L	Influent BOD Conc., mg/L	BOD/TSS Ratio	Influent NH3-N Conc., mg/L	Avg Inf TSS Load, ppd	Avg Inf BOD Load, ppd	Avg Inf NH3 Load, ppd	Load Outlier Type	30-d Avg of TSS Load, ppd	30-d Avg of BOD Load, ppd	30-d Avg of NH3-N Load, ppd	non-SN TSS Load, ppd	non-SN BOD Load, ppd	non-SN NH3 Load, ppd	30-d Avg of non-SN TSS Load, ppd	30-d Avg of non-SN BOD Load, ppd	30-d Avg of non-SN NH3-N Load, ppd
9/30/2016	FALSE	FALSE	FALSE	3.57	8.37	6.09	59%	43%	73%		1.37	5.9	5.9	238.50	191.00	0.80		12,114	9,701			12,148	9,339	1,444	12,114	9,701		12,148	9,339	1,444
10/1/2016	FALSE	FALSE	FALSE	3.54	8.41	5.82	61%	42%	69%		1.45	5.9	5.9									12,148	9,339	1,444				12,148	9,339	1,444
10/2/2016	FALSE	FALSE	TRUE	3.42	9.12	6.15	56%	38%	67%		1.48	5.9	5.9									12,148	9,339	1,444				12,148	9,339	1,444
10/3/2016	FALSE	FALSE	TRUE	3.58	8.68	6.35	56%	41%	73%		1.37	5.9	6.0									12,064	9,321	1,444				12,064	9,321	1,444
10/4/2016	FALSE	FALSE	FALSE	3.62	8.61	6.15	59%	42%	71%		1.40	5.9	6.1									12,064	9,321	1,444				12,064	9,321	1,444
10/5/2016	FALSE	FALSE	FALSE	3.54	8.12	5.99	59%	44%	74%		1.36	5.9	6.1	329.00	219.00	0.67		16,436	10,940			12,610	9,591	1,444	16,436	10,940		12,610	9,591	1,444
10/6/2016	FALSE	FALSE	FALSE	3.58	7.81	5.83	61%	46%	75%		1.34	5.9	6.0									12,610	9,591	1,444				12,610	9,591	1,444
10/7/2016	FALSE	FALSE	FALSE	3.27	7.80	5.84	56%	42%	75%		1.34	5.9	6.0	277.00	184.00	0.66		13,491	8,962			12,708	9,501	1,444	13,491	8,962		12,708	9,501	1,444
10/8/2016	FALSE	FALSE	FALSE	3.31	8.53	5.62	59%	39%	66%		1.52	5.9	6.0									12,718	9,501	1,444				12,718	9,501	1,444
10/9/2016	FALSE	FALSE	FALSE	3.20	8.03	5.51	58%	40%	69%		1.46	5.9	5.9									12,718	9,501	1,444				12,718	9,501	1,444
10/10/2016	FALSE	FALSE	FALSE	3.21	8.25	5.89	54%	39%	71%		1.40	5.9	5.9									12,588	9,636	1,444				12,588	9,636	1,444
10/11/2016	FALSE	FALSE	FALSE	3.21	7.92	5.68	57%	41%	72%		1.39	5.9	5.8									12,588	9,636	1,444				12,588	9,636	1,444
10/12/2016	FALSE	FALSE	FALSE	3.19	7.95	5.71	56%	40%	72%		1.39	5.9	5.8	308.00	202.00	0.66		14,667	9,620			12,848	9,633	1,444	14,667	9,620		12,848	9,633	1,444
10/13/2016	FALSE	FALSE	FALSE	3.26	7.75	5.74	57%	42%	74%		1.35	5.9	5.7									12,848	9,633	1,444				12,848	9,633	1,444
10/14/2016	FALSE	FALSE	TRUE	3.20	8.77	6.09	53%	36%	69%		1.44	5.9	5.8	343.00	269.00	0.78		17,421	13,663			13,356	10,137	1,444	17,421	13,663		13,356	10,137	1,444
10/15/2016	FALSE	FALSE	TRUE	3.28	8.86	5.99	55%	37%	68%		1.48	5.9	5.8									13,991	10,137	1,444				13,991	10,137	1,444
10/16/2016	FALSE	FALSE	TRUE	3.25	8.73	6.01	54%	37%	69%		1.45	5.9	5.8									13,991	10,137	1,444				13,991	10,137	1,444
10/17/2016	FALSE	FALSE	FALSE	2.39	8.32	6.08	39%	29%	73%	MinAvg	1.37	5.9	5.9									14,268	10,346	1,444				14,268	10,346	1,444
10/18/2016	FALSE	FALSE	FALSE	3.31	8.09	5.95	56%	41%	74%		1.36	5.9	5.9									14,268	10,346	1,444				14,268	10,346	1,444
10/19/2016	FALSE	FALSE	FALSE	3.27	8.04	5.86	56%	41%	73%		1.37	5.9	5.9	274.00								14,158	10,346	1,444	13,391			14,158	10,346	1,444
10/20/2016	FALSE	FALSE	FALSE	3.29	8.21	5.78	57%	40%	70%		1.42	5.9	5.9									14,158	10,346	1,444				14,158	10,346	1,444
10/21/2016	FALSE	FALSE	FALSE	3.27	8.28	5.74	57%	39%	69%		1.44	5.9	5.9	296.00	238.00	0.80		14,170	11,393			14,159	10,477	1,444	14,170	11,393		14,159	10,477	1,444
10/22/2016	FALSE	FALSE	FALSE	3.25	8.60	5.61	58%	38%	65%		1.53	5.9	5.8									14,389	10,785	1,444				14,389	10,785	1,444
10/23/2016	FALSE	FALSE	FALSE	3.20	8.21	5.62	57%	39%	68%		1.46	5.9	5.8									14,389	10,785					14,389	10,785	
10/24/2016	FALSE	FALSE	TRUE	3.20	8.50	6.02	53%	38%	71%		1.41	5.9	5.8									14,527	10,713					14,527	10,713	
10/25/2016	FALSE	FALSE	TRUE	4.60	18.57	8.91	52%	25%	48%	inMaxAvgM	2.08	5.9	5.8									14,527	10,713					14,527	10,713	
10/26/2016	FALSE	FALSE	FALSE	4.00	10.81	7.32	55%	37%	68%		1.48	5.9	6.0	206.00	197.00	0.96		12,576	12,027			14,283	10,901		12,576	12,027		14,283	10,901	
10/27/2016	FALSE	FALSE	TRUE	3.47	9.37	6.63	52%	37%	71%		1.41	6.0	6.1									14,283	10,901					14,283	10,901	
10/28/2016	FALSE	FALSE	TRUE	3.59	14.88	6.97	52%	24%	47%	inMaxAvgM	2.13	6.0	6.2	244.00	199.00	0.82		14,184	11,568			14,272	10,984		14,184	11,568		14,272	10,984	
10/29/2016	FALSE	FALSE	TRUE	4.00	15.90	7.26	55%	25%	46%	AvgMax	2.19	6.0	6.2									14,272	10,984					14,272	10,984	
10/30/2016	FALSE	FALSE	TRUE	3.65	10.01	6.90	53%	36%	69%		1.45	6.0	6.5									14,272	10,984					14,272	10,984	
10/31/2016	FALSE	FALSE	TRUE	3.50	9.52	6.77	52%	37%	71%		1.41	6.0	6.7									14,542	11,167					14,542	11,167	
11/1/2016	FALSE	FALSE	FALSE	3.81	9.44	7.08	54%	40%	75%		1.33	6.1	6.9									14,542	11,167					14,542	11,167	
11/2/2016	FALSE	FALSE	FALSE	3.59	10.10	6.60	54%	36%	65%		1.53	6.1	6.9	145.00	131.00	0.90		7,981	7,211			13,813	10,673		7,981	7,211		13,813	10,673	
11/3/2016	FALSE	FALSE	FALSE	3.45	8.87	6.37	54%	39%	72%		1.39	6.1	6.7									13,813	10,673					13,813	10,673	
11/4/2016	FALSE	FALSE	FALSE	1.93	8.67	5.98	32%	22%	69%	inAvgMinM	1.45	6.1	6.7	123.40	148.00	1.20		6,154	7,381			13,047	10,307		6,154	7,381		13,047	10,307	
11/5/2016	FALSE	FALSE	FALSE	3.35	8.25	5.96	56%	41%	72%		1.38	6.1	6.6									12,671	10,228					12,671	10,228	
11/6/2016	FALSE	FALSE	FALSE	3.00	8.45	5.94	51%	36%	70%		1.42	6.1	6.5									12,671	10,228					12,671	10,228	
11/7/2016	FALSE	FALSE	FALSE	3.28	8.40	5.96	55%	39%	71%		1.41	6.1	6.4									12,568	10,409					12,568	10,409	
11/8/2016	FALSE	FALSE	FALSE	3.31	8.21	5.86	56%	40%	71%		1.40	6.1	6.3									12,568	10,409					12,568	10,409	
11/9/2016	FALSE	FALSE	FALSE	3.33	7.99	5.82	57%	42%	73%		1.37	6.1	6.1									12,568	10,409					12,568	10,409	
11/10/2016	FALSE	FALSE	FALSE	3.27	7.89	5.81	56%	41%	74%		1.36	6.1	6.0	223.00	155.00	0.70		10,806	7,511			12,372	10,047		10,806	7,511		12,372	10,047	
11/11/2016	FALSE	FALSE	FALSE	3.29	8.36	5.84	56%	39%	70%		1.43	6.1	5.9	250.20	235.00	0.94		12,186	11,446			12,354	10,202		12,186	11,446		12,354	10,202	
11/12/2016	FALSE	FALSE	FALSE	3.28	7.54	5.62	58%	44%	75%		1.34	6.1	5.9									12,097	10,275					12,097	10,275	
11/13/2016	FALSE	FALSE	FALSE	3.19	7.95	5.67	56%	40%	71%		1.40	6.1	5.8									12,097	10,275					12,097	10,275	
11/14/2016	FALSE	FALSE	FALSE	3.23	8.01	5.81	56%	40%	73%		1.38	6.1	5.8									11,431	9,791					11,431	9,791	
11/15/2016	FALSE	FALSE	FALSE	3.36	8.27	5.93	57%	41%	72%		1.39	6.1	5.8									11,431	9,791					11,431	9,791	
11/16/2016	FALSE	FALSE	FALSE	3.29	8.40	5.87	56%	39%	70%		1.43	6.1	5.8	291.00	225.00	0.77		14,246	11,015			11,744	9,944		14,246	11,015		11,744	9,944	
11/17/2016	FALSE	FALSE	FALSE	3.28	7.96	5.84	56%	41%	73%		1.36	6.1	5.8									11,744	9,944					11,744	9,944	
11/18/2016	FALSE	TRUE	FALSE	3.23	7.89	5.74	56%	41%	73%		1.37	6.1	5.8	256.00	246.00	0.96		12,255	11,776			11,795	10,148		12,255	11,776		11,795	10,148	
11/19/2016	FALSE	TRUE	TRUE	3.31	12.93	7.15	46%	26%	55%	AvgMax	1.81	6.1	5.8									11,618	10,148					11,618	10,148	
11/20/2016	FALSE	TRUE	TRUE	4.43	11.05	7.89	56%	40%	71%		1.40	6.2	6.1									11,618	10,148					11,618	10,148	
11/21/2016	FALSE	TRUE	FALSE</																											

Date	Butte Break?	CSU Break?	Precip?	Min Influent Flow, mgd	Max Influent Flow, mgd	Avg Influent Flow, mgd	Min % of Avg	Min % of Max	Avg % of Max	Flow Outlier Type	Diurnal Peak Factor (DPF)	30-d Avg of Avg Flow, mgd	7-d Avg of Avg Flow, mgd	Influent TSS Conc., mg/L	Influent BOD Conc., mg/L	BOD/TSS Ratio	Influent NH3-N Conc., mg/L	Avg Inf TSS Load, ppd	Avg Inf BOD Load, ppd	Avg Inf NH3 Load, ppd	Load Outlier Type	30-d Avg of TSS Load, ppd	30-d Avg of BOD Load, ppd	30-d Avg of NH3-N Load, ppd	non-SN TSS Load, ppd	non-SN BOD Load, ppd	non-SN NH3 Load, ppd	30-d Avg of non-SN TSS Load, ppd	30-d Avg of non-SN BOD Load, ppd	30-d Avg of non-SN NH3-N Load, ppd
12/2/2016	FALSE	FALSE	FALSE	3.32	8.34	6.13	54%	40%	74%		1.36	6.2	6.3	252.70	213.00	0.84		12,919	10,889			11,643	10,290		12,919	10,889		11,643	10,290	
12/3/2016	FALSE	FALSE	FALSE	3.33	8.75	6.03	55%	38%	69%		1.45	6.1	6.3									12,100	10,675					12,100	10,675	
12/4/2016	FALSE	FALSE	FALSE	3.27	8.70	5.96	55%	38%	69%		1.46	6.1	6.3									12,100	10,675					12,100	10,675	
12/5/2016	FALSE	FALSE	FALSE	2.81	10.22	6.06	46%	27%	59%		1.69	6.1	6.3									12,950	11,146					12,950	11,146	
12/6/2016	FALSE	FALSE	FALSE	3.23	8.44	5.97	54%	38%	71%		1.41	6.1	6.2									12,950	11,146					12,950	11,146	
12/7/2016	FALSE	FALSE	TRUE	3.21	8.16	5.98	54%	39%	73%		1.36	6.1	6.1	281.70	283.00	1.00		14,049	14,114			13,087	11,517		14,049	14,114		13,087	11,517	
12/8/2016	FALSE	FALSE	TRUE	3.51	10.05	7.05	50%	35%	70%		1.43	6.2	6.2									13,087	11,517					13,087	11,517	
12/9/2016	FALSE	FALSE	TRUE	3.66	21.29	11.38	32%	17%	53%	igMinMaxA	1.87	6.2	6.2	125.90	134.00	1.06		11,949	12,718			12,961	11,650		11,949	12,718		12,961	11,650	
12/10/2016	FALSE	FALSE	TRUE	7.30	19.64	10.26	71%	37%	52%	inAvgAvgM	1.91	6.2	6.2									12,961	11,650					12,961	11,650	
12/11/2016	FALSE	FALSE	FALSE	4.81	11.43	8.27	58%	42%	72%		1.38	6.3	6.5									13,230	12,167					13,230	12,167	
12/12/2016	FALSE	FALSE	FALSE	4.06	10.62	7.49	54%	38%	71%		1.42	6.3	6.8									13,379	12,271					13,379	12,271	
12/13/2016	FALSE	FALSE	TRUE	3.68	10.02	7.09	52%	37%	71%		1.41	6.4	7.0									13,379	12,271					13,379	12,271	
12/14/2016	FALSE	FALSE	TRUE	4.30	11.48	8.44	51%	37%	74%		1.36	6.5	7.4				16.90			1,190		13,379	12,271	1,190		1,190		13,379	12,271	1,190
12/15/2016	FALSE	FALSE	TRUE	5.58	18.88	13.07	43%	30%	69%		1.44	6.8	8.6	242.80	180.00	0.74		26,466	19,621		TSS	13,379	13,189	1,190	26,466	19,621		13,379	13,189	1,190
12/16/2016	TRUE	TRUE	FALSE	9.30	17.60	12.53	74%	53%	71%	MinAvg	1.40	6.8	8.9									13,379	13,189	1,190				13,379	13,189	1,190
12/17/2016	TRUE	TRUE	FALSE	6.10	12.29	9.36	65%	50%	76%		1.31	6.9	9.0									13,235	13,500	1,190				13,235	13,500	1,190
12/18/2016	TRUE	TRUE	FALSE	4.77	11.66	7.95	60%	41%	68%		1.47	7.0	8.8									13,235	13,500	1,190				13,235	13,500	1,190
12/19/2016	TRUE	TRUE	FALSE	4.24	10.10	7.58	56%	42%	75%		1.33	7.1	8.7	152.90				9,666				12,803	13,787	1,190	9,666			12,803	13,787	1,190
12/20/2016	TRUE	TRUE	FALSE	4.08	9.38	7.14	57%	43%	76%		1.31	7.1	8.7									12,803	13,787	1,190				12,803	13,787	1,190
12/21/2016	TRUE	TRUE	FALSE	3.79	8.99	6.85	55%	42%	76%		1.31	7.0	8.6	170.40				9,735				12,365	13,787	1,190	9,735			12,365	13,787	1,190
12/22/2016	TRUE	TRUE	FALSE	3.64	9.11	6.68	54%	40%	73%		1.66	7.0	8.4	190.70	182.00	0.95		10,624	10,139			12,147	13,266	1,190	10,624	10,139		12,147	13,266	1,190
12/23/2016	TRUE	TRUE	TRUE	3.75	11.43	7.49	50%	33%	66%		1.53	7.1	7.6									12,147	13,266	1,190				12,147	13,266	1,190
12/24/2016	TRUE	TRUE	FALSE	4.64	10.61	7.50	62%	44%	71%		1.41	7.1	7.6									11,700	13,389	1,190				11,700	13,389	1,190
12/25/2016	TRUE	TRUE	FALSE	3.81	8.23	6.04	63%	46%	73%		1.36	7.1	7.2									11,700	13,389	1,190				11,700	13,389	1,190
12/26/2016	TRUE	TRUE	FALSE	3.56	9.04	6.21	57%	39%	69%		1.46	7.1	6.9									11,700	13,389	1,190				11,700	13,389	1,190
12/27/2016	TRUE	TRUE	FALSE	3.43	8.70	6.30	54%	39%	72%		1.38	7.1	6.8									11,700	13,389	1,190				11,700	13,389	1,190
12/28/2016	TRUE	TRUE	FALSE	3.61	8.54	6.18	58%	42%	72%		1.38	7.1	6.7	190.00	187.00	0.98		9,793	9,638			11,462	12,853	1,190	9,793	9,638		11,462	12,853	1,190
12/29/2016	TRUE	TRUE	FALSE	3.45	8.07	6.03	57%	43%	75%		1.34	7.1	6.6									11,462	12,853	1,190				11,462	12,853	1,190
12/30/2016	TRUE	TRUE	FALSE	3.45	8.13	5.94	58%	42%	73%		1.37	7.1	6.5	265.90				13,173				11,652	12,853	1,190	13,173			11,652	12,853	1,190
12/31/2016	TRUE	TRUE	TRUE	3.47	8.37	5.89	59%	41%	70%		1.42	7.0	6.3									11,488	12,853	1,190				11,488	12,853	1,190
1/1/2017	TRUE	TRUE	TRUE	3.38	7.71	5.48	62%	44%	71%		1.41	7.0	6.0									11,488	12,853	1,190				11,488	12,853	1,190
1/2/2017	TRUE	TRUE	FALSE	3.34	8.42	5.80	58%	40%	69%		1.45	7.0	6.0									11,284	13,246	1,190				11,284	13,246	1,190
1/3/2017	TRUE	TRUE	TRUE	3.35	12.17	6.75	50%	28%	55%	AvgMax	1.80	7.0	5.9									11,284	13,246	1,190				11,284	13,246	1,190
1/4/2017	TRUE	TRUE	FALSE	6.56	11.97	9.22	71%	55%	77%	inAvgMinM	1.30	7.1	5.9	174.20	189.00	1.08		13,395	14,533			11,548	13,461	1,190	13,395	14,533		11,548	13,461	1,190
1/5/2017	TRUE	TRUE	FALSE	4.36	9.74	7.55	58%	45%	78%		1.29	7.1	6.1	107.80				6,788				11,019	13,461	1,190	6,788			11,019	13,461	1,190
1/6/2017	TRUE	TRUE	FALSE	3.95	9.31	7.03	56%	42%	76%		1.32	7.2	6.3									11,019	13,461	1,190				11,019	13,461	1,190
1/7/2017	TRUE	TRUE	TRUE	3.80	12.40	8.17	47%	31%	66%		1.52	7.3	6.7									10,640	13,330	1,190				10,640	13,330	1,190
1/8/2017	TRUE	TRUE	TRUE	6.68	17.91	12.79	52%	37%	71%		1.40	7.5	7.8									10,640	13,330	1,190				10,640	13,330	1,190
1/9/2017	TRUE	TRUE	TRUE	7.99	15.14	11.28	71%	53%	75%	MinAvg	1.34	7.5	8.3									10,453	13,483	1,190				10,453	13,483	1,190
1/10/2017	TRUE	TRUE	TRUE	6.51	14.41	10.70	61%	45%	74%		1.35	7.6	9.2									10,453	13,483	1,190				10,453	13,483	1,190
1/11/2017	TRUE	TRUE	FALSE	7.64	14.07	10.74	71%	54%	76%	MinAvg	1.31	7.6	9.2	136.00	116.00	0.85		12,182	10,390			10,669	12,864	1,190	12,182	10,390		10,669	12,864	1,190
1/12/2017	TRUE	TRUE	TRUE	5.87	12.38	9.37	63%	47%	76%		1.32	7.6	9.3	129.70	115.00	0.89		10,136	8,987			10,610	12,218	1,190	10,136	8,987		10,610	12,218	1,190
1/13/2017	TRUE	TRUE	FALSE	5.16	11.64	8.53	60%	44%	73%		1.36	7.7	9.4									10,610	12,218	1,190				10,610	12,218	1,190
1/14/2017	TRUE	TRUE	FALSE	4.73	11.14	7.94	60%	42%	71%		1.40	7.7	9.6									10,610	12,218					10,610	12,218	
1/15/2017	TRUE	TRUE	FALSE	4.29	10.64	7.41	58%	40%	70%		1.44	7.5	9.5									10,610	10,738					10,610	10,738	
1/16/2017	TRUE	TRUE	TRUE	4.10	10.48	7.46	55%	39%	71%		1.40	7.5	8.6									10,610	10,738					10,610	10,738	
1/17/2017	TRUE	TRUE	FALSE	3.82	9.84	7.14	54%	39%	73%		1.38	7.4	8.4									10,610	10,738					10,610	10,738	
1/18/2017	TRUE	TRUE	TRUE	3.70	13.50	8.07	46%	27%	60%		1.67	7.4	8.0	213.50	164.00	0.77		14,369	11,038			10,986	10,788		14,369	11,038		10,986	10,788	
1/19/2017	TRUE	TRUE	TRUE	6.82	13.49	10.04	68%	51%	74%		1.34	7.5	8.2	206.60				17,299				11,749	10,788		17,299			11,749	10,788	
1/20/2017	TRUE	TRUE	TRUE	6.34	15.09	11.59	55%	42%	77%		1.30	7.6	8.5									11,749	10,788					11,749	10,788	
1/21/2017	TRUE	TRUE	TRUE	6.96	12.81	10.18	68%	54%	79%		1.26	7.8	8.7									11,973	10,788					11,973	10,788	
1/22/2017	TRUE	TRUE	TRUE	8.11	15.17	11.72	69%	53%	77%		1.29	7.9	9.2									12,142	10,917					12,142	10,917	

Date	Butte Break?	CSU Break?	Precip?	Min Influent Flow, mgd	Max Influent Flow, mgd	Avg Influent Flow, mgd	Min % of Avg	Min % of Max	Avg % of Max	Flow Outlier Type	Diurnal Peak Factor (DPF)	30-d Avg of Avg Flow, mgd	7-d Avg of Avg Flow, mgd	Influent TSS Conc., mg/L	Influent BOD Conc., mg/L	BOD/TSS Ratio	Influent NH3-N Conc., mg/L	Avg Inf TSS Load, ppd	Avg Inf BOD Load, ppd	Avg Inf NH3 Load, ppd	Load Outlier Type	30-d Avg of TSS Load, ppd	30-d Avg of BOD Load, ppd	30-d Avg of NH3-N Load, ppd	non-SN TSS Load, ppd	non-SN BOD Load, ppd	non-SN NH3 Load, ppd	30-d Avg of non-SN TSS Load, ppd	30-d Avg of non-SN BOD Load, ppd	30-d Avg of non-SN NH3-N Load, ppd
2/3/2017	FALSE	FALSE	TRUE	4.33	11.73	8.07	54%	37%	69%		1.45	8.6	7.3	198.60	216.00	1.09		13,367	14,538			12,162	11,619		13,367	14,538		12,162	11,619	
2/4/2017	FALSE	FALSE	TRUE	4.73	11.89	8.15	58%	40%	69%		1.46	8.6	7.4									12,025	11,203					12,025	11,203	
2/5/2017	FALSE	FALSE	TRUE	4.12	11.89	7.61	54%	35%	64%		1.56	8.6	7.4									12,679	11,203					12,679	11,203	
2/6/2017	FALSE	FALSE	TRUE	4.10	11.49	7.95	52%	36%	69%		1.45	8.6	7.5									12,679	11,203					12,679	11,203	
2/7/2017	FALSE	FALSE	TRUE	8.85	15.12	12.03	74%	59%	80%	inAvgMinM	1.26	8.7	7.5									12,679	11,203					12,679	11,203	
2/8/2017	FALSE	FALSE	TRUE	6.23	13.28	10.54	59%	47%	79%		1.26	8.6	8.0	183.50	132.00	0.72		16,130	11,603			13,063	11,253		16,130	11,603		13,063	11,253	
2/9/2017	FALSE	FALSE	TRUE	5.74	13.78	10.56	54%	42%	77%		1.30	8.6	8.6	173.00	152.00	0.88		15,236	13,387			13,280	11,490		15,236	13,387		13,280	11,490	
2/10/2017	FALSE	FALSE	FALSE	6.72	13.49	10.32	65%	50%	77%		1.31	8.6	9.0									13,280	11,490					13,280	11,490	
2/11/2017	FALSE	FALSE	TRUE	5.28	12.89	9.04	58%	41%	70%		1.43	8.6	9.2									13,402	11,628					13,402	11,628	
2/12/2017	FALSE	FALSE	FALSE	4.74	12.29	8.38	57%	39%	68%		1.47	8.6	9.2									13,810	12,005					13,810	12,005	
2/13/2017	FALSE	FALSE	FALSE	4.36	10.99	8.21	53%	40%	75%		1.34	8.6	9.3									13,810	12,005					13,810	12,005	
2/14/2017	FALSE	FALSE	FALSE	4.24	10.96	8.05	53%	39%	73%		1.36	8.6	9.3									13,810	12,005					13,810	12,005	
2/15/2017	FALSE	FALSE	FALSE	3.78	10.53	7.57	50%	36%	72%		1.39	8.6	9.1									13,810	12,005					13,810	12,005	
2/16/2017	FALSE	FALSE	TRUE	4.00	10.05	7.68	52%	40%	76%		1.31	8.6	8.7	257.40	206.00	0.80		16,487	13,195			14,108	12,154		16,487	13,195		14,108	12,154	
2/17/2017	FALSE	FALSE	TRUE	4.10	15.64	9.94	41%	26%	64%	MinAvg	1.57	8.7	8.5	224.00	212.00	0.95		18,570	17,575			14,554	12,756		18,570	17,575		14,554	12,756	
2/18/2017	FALSE	FALSE	TRUE	9.56	17.77	13.72	70%	54%	77%	MinAvg	1.30	8.7	8.2									14,574	12,971					14,574	12,971	
2/19/2017	FALSE	FALSE	TRUE	7.52	13.82	11.10	68%	54%	80%		1.25	8.7	8.5									14,234	12,971					14,234	12,971	
2/20/2017	FALSE	FALSE	TRUE	7.94	16.00	12.21	65%	50%	76%		1.31	8.8	9.1									14,234	12,971					14,234	12,971	
2/21/2017	FALSE	FALSE	FALSE	7.92	15.29	11.47	69%	52%	75%		1.33	8.8	9.7									14,234	12,971					14,234	12,971	
2/22/2017	FALSE	FALSE	TRUE	6.02	13.05	9.95	61%	46%	76%		1.31	8.7	10.0	173.10	146.00	0.84		14,364	12,116			14,248	12,876		14,364	12,116		14,248	12,876	
2/23/2017	FALSE	FALSE	TRUE	5.42	12.12	9.16	59%	45%	76%		1.32	8.7	10.3									14,248	12,876					14,248	12,876	
2/24/2017	FALSE	FALSE	FALSE	4.92	11.54	8.68	57%	43%	75%		1.33	8.7	10.4									14,248	12,876					14,248	12,876	
2/25/2017	FALSE	FALSE	FALSE	4.48	11.60	8.11	55%	39%	70%		1.43	8.6	10.1									14,475	13,104					14,475	13,104	
2/26/2017	FALSE	FALSE	FALSE	4.26	11.20	7.86	54%	38%	70%		1.42	8.6	9.8									14,998	13,446					14,998	13,446	
2/27/2017	FALSE	FALSE	FALSE	3.85	10.33	7.64	50%	37%	74%		1.35	8.6	9.4									14,998	13,446					14,998	13,446	
2/28/2017	FALSE	FALSE	FALSE	3.75	10.29	7.40	51%	36%	72%		1.39	8.6	8.8									14,998	13,446					14,998	13,446	
3/1/2017	FALSE	FALSE	FALSE	3.61	10.25	7.17	50%	35%	70%		1.43	8.6	8.2	194.30	209.00	1.08		11,619	12,498			14,575	13,327		11,619	12,498		14,575	13,327	
3/2/2017	FALSE	FALSE	FALSE	3.49	9.67	7.03	50%	36%	73%		1.38	8.6	7.9	111.20	98.00	0.88		6,520	5,746			13,680	12,485		6,520	5,746		13,680	12,485	
3/3/2017	FALSE	FALSE	FALSE	3.49	9.46	6.92	50%	37%	73%		1.37	8.6	7.6									13,680	12,485					13,680	12,485	
3/4/2017	FALSE	FALSE	TRUE	3.60	9.97	6.77	53%	36%	68%		1.47	8.6	7.4									13,680	12,485					13,680	12,485	
3/5/2017	FALSE	FALSE	FALSE	3.50	10.17	6.76	52%	34%	66%		1.50	8.6	7.2									14,037	12,582					14,037	12,582	
3/6/2017	FALSE	FALSE	FALSE	3.46	9.40	6.69	52%	37%	71%		1.41	8.5	7.0									14,132	12,303					14,132	12,303	
3/7/2017	FALSE	FALSE	FALSE	3.41	9.53	6.59	52%	36%	69%		1.45	8.5	6.9									14,132	12,303					14,132	12,303	
3/8/2017	FALSE	FALSE	FALSE	3.31	9.28	6.48	51%	36%	70%		1.43	8.4	6.8	239.70	241.00	1.01		12,954	13,024			13,985	12,393		12,954	13,024		13,985	12,393	
3/9/2017	FALSE	FALSE	FALSE	3.36	9.04	6.48	52%	37%	72%		1.40	8.4	6.7	218.00	241.00	1.11		11,781	13,024			13,740	12,463		11,556	12,920		13,715	12,451	
3/10/2017	FALSE	TRUE	FALSE	3.44	8.85	6.26	55%	39%	71%		1.41	8.3	6.6									13,740	12,463					13,715	12,451	
3/11/2017	FALSE	TRUE	FALSE	3.33	8.84	5.96	56%	38%	67%		1.48	8.2	6.5									13,441	12,570					13,413	12,557	
3/12/2017	FALSE	TRUE	FALSE	3.31	7.84	5.60	59%	42%	71%		1.40	8.0	6.4									13,185	12,454					13,153	12,439	
3/13/2017	FALSE	TRUE	FALSE	3.24	7.60	5.64	57%	43%	74%		1.35	7.8	6.2									13,185	12,454					13,153	12,439	
3/14/2017	FALSE	TRUE	FALSE	3.32	7.45	5.57	60%	45%	75%		1.34	7.7	6.1									13,185	12,454					13,153	12,439	
3/15/2017	FALSE	TRUE	FALSE	3.27	7.35	5.65	58%	44%	77%		1.30	7.6	6.0	245.50	240.00	0.98		11,568	11,309			12,983	12,311		11,568	11,309		12,955	12,298	
3/16/2017	FALSE	TRUE	FALSE	3.29	7.48	5.65	58%	44%	76%		1.32	7.5	5.9	242.70	239.00	0.98		11,436	11,262			12,811	12,194		11,436	11,262		12,786	12,183	
3/17/2017	TRUE	TRUE	FALSE	3.27	7.52	5.60	58%	43%	74%		1.34	7.4	5.7									12,811	12,194					12,786	12,183	
3/18/2017	TRUE	TRUE	TRUE	3.28	8.09	5.60	59%	41%	69%		1.44	7.4	5.7									12,811	12,194					12,786	12,183	
3/19/2017	TRUE	TRUE	FALSE	3.17	8.39	5.82	54%	38%	69%		1.44	7.3	5.6									12,352	12,069					12,323	12,056	
3/20/2017	TRUE	TRUE	TRUE	3.23	8.44	6.21	52%	38%	74%		1.36	7.3	5.7									11,463	11,283					11,431	11,268	
3/21/2017	TRUE	FALSE	TRUE	3.65	9.70	6.97	52%	38%	72%		1.39	7.3	5.9									11,463	11,283					11,431	11,268	
3/22/2017	TRUE	FALSE	TRUE	3.91	10.37	7.72	51%	38%	74%		1.34	7.1	6.2	288.40	271.00	0.94		18,569	17,448			12,351	12,053		18,569	17,448		12,323	12,040	
3/23/2017	TRUE	FALSE	TRUE	4.02	10.60	7.53	53%	38%	71%		1.41	7.0	6.4	235.90	204.00	0.86		14,815	12,811			12,625	12,138		14,815	12,811		12,600	12,126	
3/24/2017	TRUE	FALSE	TRUE	3.70	13.17	8.99	41%	28%	68%	MinAvg	1.46	6.8	6.5									12,625	12,138					12,600	12,126	
3/25/2017	FALSE	FALSE	FALSE	5.42	12.92	8.83	61%	42%	68%		1.46	6.8	7.0									12,408	12,140					12,379	12,127	
3/26/2017	FALSE	FALSE	TRUE	4.39	11.45	8.03	55%	38%	70%		1.43	6.8	7.3									12,408	12,140					12,379	12,127	
3/27/2017	FALSE	FALSE	FALSE	3.89	10.53	7.61	51%	37%	72%		1.38	6.7	7.6									12,408	12,140					12,379	12,127	
3/28/2017	FALSE	FALSE	FALSE	3.86	11.00	7.40	52%	35%	67%																					

Date	Butte Break?	CSU Break?	Precip?	Min Influent Flow, mgd	Max Influent Flow, mgd	Avg Influent Flow, mgd	Min % of Avg	Min % of Max	Avg % of Max	Flow Outlier Type	Diurnal Peak Factor (DPF)	30-d Avg of Avg Flow, mgd	7-d Avg of Avg Flow, mgd	Influent TSS Conc., mg/L	Influent BOD Conc., mg/L	BOD/TSS Ratio	Influent NH3-N Conc., mg/L	Avg Inf TSS Load, ppd	Avg Inf BOD Load, ppd	Avg Inf NH3 Load, ppd	Load Outlier Type	30-d Avg of TSS Load, ppd	30-d Avg of BOD Load, ppd	30-d Avg of NH3-N Load, ppd	non-SN TSS Load, ppd	non-SN BOD Load, ppd	non-SN NH3 Load, ppd	30-d Avg of non-SN TSS Load, ppd	30-d Avg of non-SN BOD Load, ppd	30-d Avg of non-SN NH3-N Load, ppd
6/9/2017	TRUE	TRUE	FALSE	3.26	7.30	5.44	60%	45%	75%		1.34	5.6	5.4									13,142	11,438				13,137	11,432		
6/10/2017	TRUE	TRUE	FALSE	3.15	7.40	5.19	61%	43%	70%		1.43	5.6	5.4									13,142	11,438				13,137	11,432		
6/11/2017	TRUE	TRUE	FALSE	3.09	7.61	5.25	59%	41%	69%		1.45	5.5	5.4									13,176	11,565				13,170	11,558		
6/12/2017	TRUE	TRUE	FALSE	3.15	7.09	5.43	58%	44%	77%		1.31	5.5	5.4									13,276	11,538				13,270	11,530		
6/13/2017	TRUE	TRUE	FALSE	3.22	7.46	5.39	60%	43%	72%		1.38	5.5	5.4									13,276	11,538				13,270	11,530		
6/14/2017	TRUE	TRUE	FALSE	3.21	7.38	5.41	59%	43%	73%		1.36	5.5	5.4									13,276	11,538				13,270	11,530		
6/15/2017	TRUE	TRUE	FALSE	3.25	7.60	5.34	61%	43%	70%		1.42	5.5	5.4									13,276	11,538				13,270	11,530		
6/16/2017	TRUE	TRUE	FALSE	3.20	7.50	5.25	61%	43%	70%		1.43	5.5	5.3	298.00	286.00	0.96		13,048	12,523			13,251	11,647		13,048	12,523	13,245	11,640		
6/17/2017	TRUE	TRUE	FALSE	3.21	7.14	5.12	63%	45%	72%		1.39	5.4	5.3									13,236	11,571				13,236	11,571		
6/18/2017	TRUE	TRUE	FALSE	3.21	7.31	5.02	64%	44%	69%		1.46	5.4	5.3									13,377	11,447				13,377	11,447		
6/19/2017	TRUE	TRUE	FALSE	3.17	6.97	4.58	69%	45%	66%		1.52	5.4	5.2	230.00	240.00	1.04		8,785	9,167			12,803	11,162		8,785	9,167	12,803	11,162		
6/20/2017	TRUE	TRUE	FALSE	4.30	7.00	5.35	80%	61%	76%	inAvgMinM	1.31	5.4	5.2									12,803	11,162				12,803	11,162		
6/21/2017	TRUE	TRUE	FALSE	5.43	7.04	6.12	89%	77%	87%	gMinMaxA	1.15	5.4	5.1	269.00	252.00	0.94		13,730	12,862			12,906	11,351		13,730	12,862	12,906	11,351		
6/22/2017	TRUE	TRUE	FALSE	3.20	7.35	5.35	60%	44%	73%		1.37	5.3	5.1	252.00								12,740	11,351		11,036		12,719	11,351		
6/23/2017	TRUE	TRUE	FALSE	3.23	7.25	5.25	62%	45%	72%		1.38	5.3	5.1									12,768	11,466				12,745	11,466		
6/24/2017	TRUE	TRUE	FALSE	3.23	7.19	5.06	64%	45%	70%		1.42	5.3	5.1									12,768	11,466				12,745	11,466		
6/25/2017	TRUE	TRUE	FALSE	3.15	7.12	5.09	62%	44%	71%		1.40	5.3	5.1									12,768	11,466				12,745	11,466		
6/26/2017	TRUE	TRUE	FALSE	3.17	7.10	5.31	60%	45%	75%		1.34	5.3	5.1									12,715	11,318				12,688	11,318		
6/27/2017	TRUE	TRUE	FALSE	3.23	7.50	5.35	60%	43%	71%		1.40	5.3	5.2									12,715	11,318				12,688	11,318		
6/28/2017	TRUE	TRUE	FALSE	3.24	7.55	5.38	60%	43%	71%		1.40	5.3	5.3	301.00	264.00	0.88		13,506	11,845			12,802	11,384		13,506	11,845	12,779	11,384		
6/29/2017	TRUE	TRUE	FALSE	3.17	7.38	5.35	59%	43%	72%		1.38	5.3	5.3	267.00	202.00	0.76		11,913	9,013			12,713	11,121		11,913	9,013	12,693	11,121		
6/30/2017	TRUE	TRUE	FALSE	3.15	7.26	5.25	60%	43%	72%		1.38	5.3	5.3									12,713	11,121				12,693	11,121		
7/1/2017	TRUE	TRUE	FALSE	3.22	7.16	5.04	64%	45%	70%		1.42	5.3	5.2									12,300	11,035				12,277	11,035		
7/2/2017	TRUE	TRUE	FALSE	3.15	6.80	4.85	65%	46%	71%		1.40	5.3	5.2									12,303	11,164				12,277	11,164		
7/3/2017	TRUE	TRUE	FALSE	3.17	6.92	4.94	64%	46%	71%		1.40	5.2	5.2									12,303	11,164				12,277	11,164		
7/4/2017	TRUE	TRUE	FALSE	0.55	6.69	4.77	12%	8%	71%	inAvgMinM	1.40	5.2	5.2									12,303	11,164				12,277	11,164		
7/5/2017	TRUE	TRUE	FALSE	3.14	6.63	5.01	63%	47%	76%		1.32	5.2	5.1	227.80	210.00	0.92		9,518	8,775			11,993	10,865		9,518	8,775	11,970	10,865		
7/6/2017	TRUE	TRUE	FALSE	3.22	7.09	5.22	62%	45%	74%		1.36	5.2	5.1	256.00								11,909	10,865		11,145		11,888	10,865		
7/7/2017	TRUE	TRUE	FALSE	3.18	7.27	5.20	61%	44%	72%		1.40	5.2	5.1									11,909	10,865				11,888	10,865		
7/8/2017	TRUE	TRUE	FALSE	3.28	6.99	5.03	65%	47%	72%		1.39	5.2	5.0									11,812	11,043				11,789	11,043		
7/9/2017	TRUE	TRUE	FALSE	3.15	6.91	4.99	63%	46%	72%		1.38	5.2	5.0									11,611	10,698				11,585	10,698		
7/10/2017	TRUE	TRUE	FALSE	3.18	7.13	5.32	60%	45%	75%		1.34	5.2	5.1									11,611	10,698				11,585	10,698		
7/11/2017	TRUE	TRUE	FALSE	3.29	7.37	5.33	62%	45%	72%		1.38	5.2	5.2									11,611	10,698				11,585	10,698		
7/12/2017	TRUE	TRUE	FALSE	3.32	7.53	5.36	62%	44%	71%		1.40	5.2	5.2	275.00	191.00	0.69		12,293	8,538			11,687	10,389		12,293	8,538	11,664	10,389		
7/13/2017	TRUE	TRUE	FALSE	3.21	7.42	5.41	59%	43%	73%		1.37	5.2	5.2		220.00							11,687	10,331			9,855	11,664	10,322		
7/14/2017	TRUE	TRUE	FALSE	3.35	7.43	5.29	63%	45%	71%		1.40	5.2	5.2	229.00	169.00	0.74		10,103	7,456			11,529	10,012		10,103	7,456	11,508	10,004		
7/15/2017	TRUE	TRUE	FALSE	3.23	7.06	5.06	64%	46%	72%		1.40	5.2	5.2									11,529	10,012				11,508	10,004		
7/16/2017	TRUE	TRUE	FALSE	3.19	6.85	4.99	64%	47%	73%		1.37	5.2	5.2									11,529	10,012				11,508	10,004		
7/17/2017	TRUE	TRUE	FALSE	3.31	7.08	5.27	63%	47%	74%		1.34	5.2	5.3									11,360	9,698				11,337	9,689		
7/18/2017	TRUE	TRUE	FALSE	3.23	7.34	5.72	56%	44%	78%		1.28	5.2	5.3									11,360	9,698				11,337	9,689		
7/19/2017	TRUE	TRUE	FALSE	3.19	7.37	5.24	61%	43%	71%		1.41	5.2	5.3	236.80	274.00	1.16		10,349	11,974			11,259	9,951		10,349	11,974	11,238	9,943		
7/20/2017	TRUE	TRUE	FALSE	3.19	7.33	5.24	61%	44%	71%		1.40	5.2	5.3	267.50	274.00	1.02		11,690	11,974			11,549	10,263		11,690	11,974	11,528	10,255		
7/21/2017	TRUE	TRUE	FALSE	3.20	7.34	5.20	62%	44%	71%		1.41	5.2	5.3									11,549	10,263				11,528	10,255		
7/22/2017	TRUE	TRUE	FALSE	3.22	6.95	5.01	64%	46%	72%		1.39	5.2	5.2									11,307	9,938				11,284	9,929		
7/23/2017	TRUE	TRUE	FALSE	3.14	7.04	4.98	63%	45%	71%		1.41	5.2	5.2									11,315	9,938				11,315	9,929		
7/24/2017	TRUE	TRUE	FALSE	3.18	7.01	5.19	61%	45%	74%		1.35	5.2	5.2									11,315	9,938				11,315	9,929		
7/25/2017	TRUE	TRUE	FALSE	3.13	7.06	5.19	60%	44%	74%		1.36	5.2	5.2									11,315	9,938				11,315	9,929		
7/26/2017	TRUE	TRUE	FALSE	3.20	7.31	5.23	61%	44%	72%		1.40	5.2	5.2	249.00	197.00	0.79		10,861	8,593			11,264	9,788		10,861	8,593	11,264	9,780		
7/27/2017	TRUE	TRUE	FALSE	3.10	7.13	5.19	60%	43%	73%		1.37	5.2	5.2	255.00	222.00	0.87		11,038	9,609			11,242	9,770		11,038	9,609	11,242	9,763		
7/28/2017	TRUE	TRUE	FALSE	3.14	7.20	5.13	61%	44%	71%		1.40	5.2	5.1									11,242	9,770				11,242	9,763		
7/29/2017	TRUE	TRUE	FALSE	3.17	6.93	4.97	64%	46%	72%		1.39	5.2	5.1									10,990	9,540				10,990	9,532		
7/30/2017	TRUE	TRUE	FALSE	3.12	6.92	4.95	63%	45%	72%		1.40	5.2	5.1									10,875	9,606				10,875	9,597		
7/31/2017	TRUE	TRUE	FALSE	3.14	7.20	5.31	59%	44%	74%		1.36	5.2	5.1									10,875	9,606				10,875	9,597		
8/1/2017	TRUE	TRUE	FALSE	3.27	7.37	5.33	61%	44%	72%		1.38	5.2	5.2									10,875	9,606				10,875	9,597		
8/2/2017	TRUE	TRUE	FALSE	3.21	7.23	5.30	61%	44%	73%		1.36	5.2	5.2	272.80	187.00	0.69		12,058	8,266			11,006	9,457		12,058	8,266	11,006			

Date	Butte Break?	CSU Break?	Precip?	Min Influent Flow, mgd	Max Influent Flow, mgd	Avg Influent Flow, mgd	Min % of Avg	Min % of Max	Avg % of Max	Flow Outlier Type	Diurnal Peak Factor (DPF)	30-d Avg of Avg Flow, mgd	7-d Avg of Avg Flow, mgd	Influent TSS Conc., mg/L	Influent BOD Conc., mg/L	BOD/TSS Ratio	Influent NH3-N Conc., mg/L	Avg Inf TSS Load, ppd	Avg Inf BOD Load, ppd	Avg Inf NH3 Load, ppd	Load Outlier Type	30-d Avg of TSS Load, ppd	30-d Avg of BOD Load, ppd	30-d Avg of NH3-N Load, ppd	non-SN TSS Load, ppd	non-SN BOD Load, ppd	non-SN NH3 Load, ppd	30-d Avg of non-SN TSS Load, ppd	30-d Avg of non-SN BOD Load, ppd	30-d Avg of non-SN NH3-N Load, ppd
8/11/2017	TRUE	TRUE	FALSE	3.23	7.45	5.38	60%	43%	72%		1.38	5.2	5.3									10,924	9,311				10,924	9,304		
8/12/2017	TRUE	TRUE	FALSE	3.24	7.38	5.21	62%	44%	71%		1.42	5.2	5.3									10,772	9,388				10,772	9,381		
8/13/2017	TRUE	TRUE	FALSE	3.19	7.42	5.27	61%	43%	71%		1.41	5.2	5.3									10,772	9,328				10,772	9,328		
8/14/2017	TRUE	TRUE	FALSE	3.20	7.44	5.57	57%	43%	75%		1.34	5.2	5.4									10,855	9,562				10,855	9,562		
8/15/2017	TRUE	TRUE	FALSE	3.26	7.72	5.56	59%	42%	72%		1.39	5.3	5.4									10,855	9,562				10,855	9,562		
8/16/2017	TRUE	TRUE	FALSE	3.19	7.81	5.54	58%	41%	71%		1.41	5.3	5.4	222.65	241.00	1.08		10,287	11,135			10,792	9,737		10,287	11,135	10,792	9,737		
8/17/2017	TRUE	TRUE	FALSE	3.29	7.59	5.63	58%	43%	74%		1.35	5.3	5.5	254.00	308.00	1.21		11,926	14,462			10,906	10,209		11,926	14,462	10,906	10,209		
8/18/2017	TRUE	TRUE	FALSE	3.21	7.70	5.66	57%	42%	74%		1.36	5.3	5.5									10,906	10,209				10,906	10,209		
8/19/2017	TRUE	TRUE	FALSE	3.26	8.27	5.65	58%	39%	68%		1.46	5.3	5.5									10,968	10,013				10,968	10,013		
8/20/2017	TRUE	TRUE	FALSE	3.16	8.48	5.80	54%	37%	68%		1.46	5.3	5.6									10,877	9,768				10,877	9,768		
8/21/2017	TRUE	TRUE	FALSE	3.15	8.85	5.84	54%	36%	66%		1.52	5.3	5.7									10,877	9,768				10,877	9,768		
8/22/2017	FALSE	FALSE	FALSE	3.32	8.90	5.98	56%	37%	67%		1.49	5.4	5.7									10,877	9,768				10,877	9,768		
8/23/2017	FALSE	FALSE	FALSE	3.15	8.78	5.89	53%	36%	67%		1.49	5.4	5.7	265.00	306.00	1.15		13,017	15,032			11,115	10,353		13,017	15,032	11,115	10,353		
8/24/2017	FALSE	FALSE	FALSE	3.20	8.57	5.97	54%	37%	70%		1.44	5.4	5.8									11,115	10,353				11,115	10,353		
8/25/2017	FALSE	FALSE	FALSE	3.24	8.25	5.83	56%	39%	71%		1.42	5.4	5.8									11,115	10,353				11,115	10,353		
8/26/2017	FALSE	FALSE	FALSE	3.25	8.39	5.66	57%	39%	67%		1.48	5.5	5.8									11,147	10,573				11,147	10,573		
8/27/2017	FALSE	FALSE	FALSE	3.16	8.57	5.66	56%	37%	66%		1.51	5.5	5.8									11,163	10,711				11,163	10,711		
8/28/2017	FALSE	FALSE	FALSE	3.25	8.89	5.82	56%	37%	65%		1.53	5.5	5.8									11,163	10,711				11,163	10,711		
8/29/2017	FALSE	FALSE	FALSE	3.26	8.38	5.78	56%	39%	69%		1.45	5.5	5.8									11,163	10,711				11,163	10,711		
8/30/2017	FALSE	FALSE	FALSE	3.22	8.48	5.95	54%	38%	70%		1.43	5.6	5.8									11,163	10,711				11,163	10,711		
8/31/2017	FALSE	FALSE	FALSE	3.18	8.65	5.82	55%	37%	67%		1.49	5.6	5.8	236.40	329.00	1.39		11,475	15,969			11,202	11,368		11,475	15,969	11,202	11,368		
9/1/2017	FALSE	FALSE	FALSE	3.21	8.22	5.80	55%	39%	71%		1.42	5.6	5.8	228.60	316.00	1.38		11,058	15,286			11,186	11,803		11,058	15,286	11,186	11,803		
9/2/2017	FALSE	FALSE	FALSE	3.25	7.98	5.54	59%	41%	69%		1.44	5.6	5.8									11,076	12,245				11,076	12,245		
9/3/2017	FALSE	FALSE	FALSE	3.22	7.97	5.41	60%	40%	68%		1.47	5.6	5.7									11,535	13,144				11,535	13,144		
9/4/2017	FALSE	FALSE	FALSE	3.19	8.43	5.70	56%	38%	68%		1.48	5.6	5.7									11,535	13,144				11,535	13,144		
9/5/2017	FALSE	FALSE	TRUE	3.25	8.35	5.92	55%	39%	71%		1.41	5.6	5.7									11,535	13,144				11,535	13,144		
9/6/2017	FALSE	FALSE	FALSE	3.36	8.58	6.00	56%	39%	70%		1.43	5.7	5.8									11,535	13,144				11,535	13,144		
9/7/2017	FALSE	FALSE	FALSE	3.23	8.68	6.02	54%	37%	69%		1.44	5.7	5.8	294.50	390.00	1.32		14,786	19,581		BOD	11,941	13,144		14,786	19,581	11,941	13,144		
9/8/2017	FALSE	FALSE	FALSE	3.22	8.33	5.91	54%	39%	71%		1.41	5.7	5.8	237.40	315.00	1.33		11,701	15,526			11,915	13,442		11,701	15,526	11,915	13,442		
9/9/2017	FALSE	FALSE	FALSE	3.20	8.33	5.72	56%	38%	69%		1.46	5.7	5.8									11,936	13,871				11,936	13,871		
9/10/2017	FALSE	FALSE	FALSE	3.22	8.41	5.80	56%	38%	69%		1.45	5.7	5.8									12,036	14,568				12,036	14,568		
9/11/2017	FALSE	FALSE	FALSE	3.12	8.39	5.94	53%	37%	71%		1.41	5.7	5.9									12,036	14,568				12,036	14,568		
9/12/2017	FALSE	FALSE	FALSE	3.37	8.80	6.00	56%	38%	68%		1.47	5.8	5.9				50.90			2,547	NH3	12,036	14,568				12,036	14,568		
9/13/2017	FALSE	FALSE	FALSE	3.41	8.58	6.00	57%	40%	70%		1.43	5.8	5.9	195.70	221.00	1.13		9,793	11,059			11,755	14,067		9,793	11,059	11,755	14,067		
9/14/2017	FALSE	FALSE	FALSE	3.24	8.79	6.03	54%	37%	69%		1.46	5.8	5.9	257.10	284.00	1.10		12,930	14,282			11,886	14,094		12,930	14,282	11,886	14,094		
9/15/2017	FALSE	FALSE	FALSE	3.21	8.23	5.92	54%	39%	72%		1.39	5.8	5.9									11,886	14,094				11,886	14,094		
9/16/2017	FALSE	FALSE	FALSE	3.27	8.45	5.74	57%	39%	68%		1.47	5.8	5.9									12,086	14,517				12,086	14,517		
9/17/2017	FALSE	FALSE	FALSE	3.19	8.71	5.82	55%	37%	67%		1.50	5.8	5.9									12,109	14,526				12,109	14,526		
9/18/2017	FALSE	FALSE	FALSE	3.31	8.37	6.01	55%	40%	72%		1.39	5.8	5.9									12,109	14,526				12,109	14,526		
9/19/2017	FALSE	FALSE	FALSE	3.15	8.36	5.99	53%	38%	72%		1.40	5.8	5.9									12,109	14,526				12,109	14,526		
9/20/2017	FALSE	FALSE	FALSE	3.25	8.59	6.09	53%	38%	71%		1.41	5.9	6.0	258.90	385.00	1.49		13,150	19,554			12,239	15,244		13,150	19,554	12,239	15,244		
9/21/2017	FALSE	FALSE	FALSE	3.20	8.38	6.01	53%	38%	72%		1.39	5.9	6.0	289.60	282.00	0.97		14,516	14,135			12,492	15,105		14,516	14,135	12,492	15,105		
9/22/2017	FALSE	FALSE	FALSE	3.21	8.48	5.88	55%	38%	69%		1.44	5.9	5.9									12,492	15,105				12,492	15,105		
9/23/2017	FALSE	FALSE	FALSE	3.16	8.57	5.73	55%	37%	67%		1.50	5.9	5.9									12,426	15,116				12,426	15,116		
9/24/2017	FALSE	FALSE	FALSE	3.21	8.79	5.87	55%	37%	67%		1.50	5.9	5.9									12,426	15,116				12,426	15,116		
9/25/2017	FALSE	FALSE	FALSE	3.17	8.33	5.94	53%	38%	71%		1.40	5.9	5.9									12,426	15,116				12,426	15,116		
9/26/2017	FALSE	FALSE	FALSE	3.17	9.21	5.94	53%	34%	64%		1.55	5.9	5.9									12,426	15,116				12,426	15,116		
9/27/2017	FALSE	FALSE	FALSE	3.24	8.53	5.90	55%	38%	69%		1.45	5.9	5.9	247.80								12,400	15,116		12,193		12,400	15,116		
9/28/2017	FALSE	FALSE	FALSE	3.22	8.81	5.93	54%	37%	67%		1.49	5.9	5.9	247.90	266.00	1.07		12,260	13,155			12,386	14,871		12,059	13,115	12,366	14,866		
9/29/2017	FALSE	FALSE	FALSE	3.19	8.33	5.96	54%	38%	72%		1.40	5.9	5.9									12,386	14,871				12,366	14,866		
9/30/2017	FALSE	FALSE	FALSE	3.25	8.63	5.76	56%	38%	67%		1.50	5.9	5.9									12,386	14,871				12,366	14,866		
10/1/2017	FALSE	FALSE	FALSE	3.14	8.56	5.78	54%	37%	68%		1.48	5.9	5.9									12,487	14,714				12,465	14,708		
10/2/2017	FALSE	FALSE	FALSE	3.13	8.31	5.80	54%	38%	70%		1.43	5.9	5.9									12,666	14,619				12,641	14,612		
10/3/2017	FALSE	FALSE	FALSE	3.21	8.49	5.90	54%	38%	69%		1.44	5.9	5.9									12,666	14,619				12,641	14,612		
10/4/2017	FALSE	FALSE	FALSE	3.18	8.82	5.85	54%	36%	66%		1.51	5.9	5.9	273.50	289.00	1.06		13,344	14,100			12,741	14,545		13,344	14,100				

Date	Butte Break?	CSU Break?	Precip?	Min Influent Flow, mgd	Max Influent Flow, mgd	Avg Influent Flow, mgd	Min % of Avg	Min % of Max	Avg % of Max	Flow Outlier Type	Diurnal Peak Factor (DPF)	30-d Avg of Avg Flow, mgd	7-d Avg of Avg Flow, mgd	Influent TSS Conc., mg/L	Influent BOD Conc., mg/L	BOD/TSS Ratio	Influent NH3-N Conc., mg/L	Avg Inf TSS Load, ppd	Avg Inf BOD Load, ppd	Avg Inf NH3 Load, ppd	Load Outlier Type	30-d Avg of TSS Load, ppd	30-d Avg of BOD Load, ppd	30-d Avg of NH3-N Load, ppd	non-SN TSS Load, ppd	non-SN BOD Load, ppd	non-SN NH3 Load, ppd	30-d Avg of non-SN TSS Load, ppd	30-d Avg of non-SN BOD Load, ppd	30-d Avg of non-SN NH3-N Load, ppd
10/13/2017	FALSE	FALSE	FALSE	3.20	8.47	5.84	55%	38%	69%		1.45	5.9	5.8									13,069	14,004				13,049	14,000		
10/14/2017	FALSE	FALSE	FALSE	3.17	8.65	5.73	55%	37%	66%		1.51	5.9	5.8									13,434	14,372				13,411	14,367		
10/15/2017	FALSE	FALSE	FALSE	3.16	8.87	5.78	55%	36%	65%		1.53	5.9	5.8									13,497	14,385				13,471	14,380		
10/16/2017	FALSE	FALSE	FALSE	3.17	8.44	5.86	54%	38%	69%		1.44	5.9	5.8									13,497	14,385				13,471	14,380		
10/17/2017	FALSE	FALSE	FALSE	3.22	8.39	5.88	55%	38%	70%		1.43	5.9	5.8									13,497	14,385				13,471	14,380		
10/18/2017	FALSE	FALSE	FALSE	3.15	8.27	5.80	54%	38%	70%		1.43	5.9	5.8	238.90	261.00	1.09		11,556	12,625			13,281	14,165		11,556	12,625	13,258	14,160		
10/19/2017	FALSE	FALSE	TRUE	3.23	8.65	5.91	55%	37%	68%		1.46	5.9	5.8	300.50	296.00	0.99		14,811	14,590			13,434	14,212		14,811	14,590	13,414	14,208		
10/20/2017	FALSE	FALSE	TRUE	3.27	8.37	6.04	54%	39%	72%		1.39	5.9	5.9									13,434	14,212				13,414	14,208		
10/21/2017	FALSE	FALSE	FALSE	3.24	8.66	5.84	55%	37%	67%		1.48	5.9	5.9									13,466	13,545				13,443	13,540		
10/22/2017	FALSE	FALSE	FALSE	3.24	8.74	5.84	55%	37%	67%		1.50	5.8	5.9									13,334	13,460				13,309	13,455		
10/23/2017	FALSE	FALSE	FALSE	3.17	8.44	5.89	54%	38%	70%		1.43	5.8	5.9									13,334	13,460				13,309	13,455		
10/24/2017	FALSE	FALSE	FALSE	3.20	8.64	5.84	55%	37%	68%		1.48	5.9	5.9									13,334	13,460				13,309	13,455		
10/25/2017	FALSE	FALSE	FALSE	3.19	8.79	5.87	54%	36%	67%		1.50	5.9	5.9	281.50	194.00	0.69		13,781	9,497			13,384	12,965		13,781	9,497	13,362	12,960		
10/26/2017	FALSE	FALSE	FALSE	3.24	8.39	5.95	54%	39%	71%		1.41	5.9	5.9	276.00	232.00	0.84		13,696	11,513			13,415	12,804		13,696	11,513	13,395	12,799		
10/27/2017	FALSE	FALSE	FALSE	3.24	8.44	5.93	55%	38%	70%		1.42	5.9	5.9									13,415	12,804				13,395	12,799		
10/28/2017	FALSE	FALSE	FALSE	3.24	8.50	5.85	55%	38%	69%		1.45	5.8	5.9									13,551	12,804				13,528	12,799		
10/29/2017	FALSE	FALSE	FALSE	3.23	8.46	5.79	56%	38%	68%		1.46	5.8	5.9									13,712	12,760				13,712	12,760		
10/30/2017	FALSE	FALSE	FALSE	3.33	8.41	5.90	56%	40%	70%		1.43	5.8	5.9									13,712	12,760				13,712	12,760		
10/31/2017	FALSE	FALSE	FALSE	3.20	8.72	5.85	55%	37%	67%		1.49	5.8	5.9									13,712	12,760				13,712	12,760		
11/1/2017	FALSE	FALSE	FALSE	3.20	8.40	5.87	55%	38%	70%		1.43	5.8	5.9	257.60				12,611				13,590	12,760		12,611		13,590	12,760		
11/2/2017	FALSE	FALSE	FALSE	3.22	8.45	5.99	54%	38%	71%		1.41	5.9	5.9	135.70	91.00	0.67		6,779	4,546			12,909	11,847		6,779	4,546	12,909	11,847		
11/3/2017	FALSE	FALSE	TRUE	3.21	8.42	6.03	53%	38%	72%		1.40	5.9	5.9									12,909	11,847				12,909	11,847		
11/4/2017	FALSE	FALSE	TRUE	3.51	9.47	6.33	55%	37%	67%		1.50	5.9	6.0									12,860	11,565				12,860	11,565		
11/5/2017	FALSE	FALSE	FALSE	3.25	9.55	6.20	52%	34%	65%		1.54	5.9	6.0									12,896	11,361				12,896	11,361		
11/6/2017	FALSE	FALSE	FALSE	3.25	8.63	6.07	54%	38%	70%		1.42	5.9	6.0									12,896	11,361				12,896	11,361		
11/7/2017	FALSE	FALSE	FALSE	3.26	8.42	6.01	54%	39%	71%		1.40	5.9	6.0									12,896	11,361				12,896	11,361		
11/8/2017	FALSE	FALSE	TRUE	3.20	9.31	6.15	52%	34%	66%		1.51	5.9	6.1	251.70	270.00	1.07		12,910	13,849			12,898	11,672		12,910	13,849	12,898	11,672		
11/9/2017	FALSE	FALSE	TRUE	3.63	9.56	6.92	52%	38%	72%		1.38	6.0	6.2	199.10	240.00	1.21		11,491	13,851			12,757	11,914		11,491	13,851	12,757	11,914		
11/10/2017	FALSE	FALSE	TRUE	3.40	9.54	6.51	52%	36%	68%		1.47	6.0	6.3									12,757	11,914				12,757	11,914		
11/11/2017	FALSE	FALSE	FALSE	3.38	9.00	6.15	55%	38%	68%		1.46	6.0	6.3									12,721	11,657				12,721	11,657		
11/12/2017	FALSE	FALSE	FALSE	3.27	8.83	6.13	53%	37%	69%		1.44	6.0	6.3									12,204	11,496				12,204	11,496		
11/13/2017	FALSE	FALSE	TRUE	3.25	8.60	6.27	52%	38%	73%		1.37	6.0	6.3									12,204	11,496				12,204	11,496		
11/14/2017	FALSE	FALSE	FALSE	3.34	8.69	6.23	54%	38%	72%		1.39	6.0	6.3									12,204	11,496				12,204	11,496		
11/15/2017	FALSE	FALSE	TRUE	3.27	9.50	6.65	49%	34%	70%		1.43	6.1	6.4	234.50	252.00	1.07		13,006	13,976			12,293	11,806		13,006	13,976	12,293	11,806		
11/16/2017	FALSE	FALSE	TRUE	3.61	9.43	6.99	52%	38%	74%		1.35	6.1	6.5	247.80	319.00	1.29		14,446	18,597			12,509	12,560		14,446	18,597	12,509	12,560		
11/17/2017	FALSE	TRUE	FALSE	3.64	8.96	6.63	55%	41%	74%		1.35	6.1	6.4									12,509	12,560				12,509	12,560		
11/18/2017	FALSE	TRUE	FALSE	3.62	8.64	6.13	59%	42%	71%		1.41	6.1	6.4									12,615	12,552				12,615	12,552		
11/19/2017	FALSE	TRUE	FALSE	3.47	8.51	5.92	59%	41%	70%		1.44	6.1	6.4									12,340	12,261				12,340	12,261		
11/20/2017	FALSE	TRUE	TRUE	3.46	8.63	6.18	56%	40%	72%		1.40	6.1	6.4									12,340	12,261				12,340	12,261		
11/21/2017	FALSE	TRUE	TRUE	3.64	8.33	6.27	58%	44%	75%		1.33	6.1	6.4	139.40	175.00	1.26		7,289	9,151			11,779	11,872		7,289	9,151	11,779	11,872		
11/22/2017	TRUE	TRUE	FALSE	3.42	8.26	6.05	57%	41%	73%		1.37	6.1	6.4									11,779	11,872				11,779	11,872		
11/23/2017	TRUE	TRUE	TRUE	3.26	9.03	5.47	60%	36%	61%		1.65	6.1	6.2									11,779	11,872				11,779	11,872		
11/24/2017	TRUE	TRUE	FALSE	3.21	7.67	5.22	61%	42%	68%		1.47	6.1	6.0									11,779	11,872				11,779	11,872		
11/25/2017	TRUE	TRUE	FALSE	3.21	8.14	5.44	59%	39%	67%		1.50	6.1	5.8									11,528	12,212				11,528	12,212		
11/26/2017	TRUE	TRUE	TRUE	3.20	9.66	6.39	50%	33%	66%		1.51	6.1	5.9									11,219	12,328				11,219	12,328		
11/27/2017	TRUE	TRUE	TRUE	3.39	9.28	6.85	49%	37%	74%		1.35	6.1	6.0									11,219	12,328				11,219	12,328		
11/28/2017	FALSE	FALSE	FALSE	3.43	9.11	6.65	52%	38%	73%		1.37	6.2	6.0									11,219	12,328				11,219	12,328		
11/29/2017	FALSE	FALSE	FALSE	3.33	9.11	6.43	52%	37%	71%		1.42	6.2	6.1	198.00	229.00	1.16		10,618	12,280			11,144	12,321		10,618	12,280	11,144	12,321		
11/30/2017	FALSE	FALSE	FALSE	3.30	8.65	6.27	53%	38%	72%		1.38	6.2	6.1	243.30	229.00	0.94		12,723	11,975			11,319	12,278		12,723	11,975	11,319	12,278		
12/1/2017	FALSE	FALSE	FALSE	3.35	8.45	6.18	54%	40%	73%		1.37	6.2	6.2									11,319	12,278				11,319	12,278		
12/2/2017	FALSE	FALSE	FALSE	3.30	9.32	6.17	53%	35%	66%		1.51	6.2	6.3									11,158	12,278				11,158	12,278		
12/3/2017	FALSE	FALSE	FALSE	3.25	8.96	6.17	53%	36%	69%		1.45	6.2	6.4									11,783	13,383				11,783	13,383		
12/4/2017	FALSE	FALSE	FALSE	3.20	8.48	6.08	53%	38%	72%		1.39	6.2	6.4									11,783	13,383				11,783	13,383		
12/5/2017	FALSE	FALSE	FALSE	3.23	8.54	6.04	53%	38%	71%		1.41	6.2	6.2									11,783	13,383				11,783	13,383		
12/6/2017	FALSE	FALSE	FALSE	3.20	8.58	6.05	53%	37%	71%		1.42	6.2	6.2	265.00	364.00	1.37		13,371	18,366											

Date	Butte Break?	CSU Break?	Precip?	Min Influent Flow, mgd	Max Influent Flow, mgd	Avg Influent Flow, mgd	Min % of Avg	Min % of Max	Avg % of Max	Flow Outlier Type	Diurnal Peak Factor (DPF)	30-d Avg of Avg Flow, mgd	7-d Avg of Avg Flow, mgd	Influent TSS Conc., mg/L	Influent BOD Conc., mg/L	BOD/TSS Ratio	Influent NH3-N Conc., mg/L	Avg Inf TSS Load, ppd	Avg Inf BOD Load, ppd	Avg Inf NH3 Load, ppd	Load Outlier Type	30-d Avg of TSS Load, ppd	30-d Avg of BOD Load, ppd	30-d Avg of NH3-N Load, ppd	non-SN TSS Load, ppd	non-SN BOD Load, ppd	non-SN NH3 Load, ppd	30-d Avg of non-SN TSS Load, ppd	30-d Avg of non-SN BOD Load, ppd	30-d Avg of non-SN NH3-N Load, ppd
12/15/2017	TRUE	TRUE	FALSE	3.05	7.80	5.84	52%	39%	75%		1.34	6.1	5.9									12,352	13,824				12,308	13,808		
12/16/2017	TRUE	TRUE	FALSE	3.15	7.97	5.61	56%	40%	70%		1.42	6.1	5.9									12,270	13,805				12,220	13,787		
12/17/2017	TRUE	TRUE	FALSE	3.11	7.79	5.51	56%	40%	71%		1.41	6.0	5.8									11,959	13,120				11,903	13,100		
12/18/2017	TRUE	TRUE	FALSE	3.16	7.38	5.52	57%	43%	75%		1.34	6.0	5.8									11,959	13,120				11,903	13,100		
12/19/2017	TRUE	TRUE	FALSE	3.14	7.52	5.62	56%	42%	75%		1.34	6.0	5.7									11,959	13,120				11,903	13,100		
12/20/2017	TRUE	TRUE	TRUE	3.22	7.42	5.59	58%	43%	75%		1.33	6.0	5.7									11,959	13,120				11,903	13,100		
12/21/2017	TRUE	TRUE	FALSE	3.10	7.48	5.56	56%	41%	74%		1.35	6.0	5.6	270.90	274.00	1.01		12,562	12,705			12,034	13,068	12,562	12,705		11,985	13,051		
12/22/2017	TRUE	TRUE	FALSE	3.22	7.47	5.55	58%	43%	74%		1.35	5.9	5.6									12,712	13,628				12,656	13,608		
12/23/2017	TRUE	TRUE	FALSE	3.14	7.93	5.42	58%	40%	68%		1.46	5.9	5.5									12,712	13,628				12,656	13,608		
12/24/2017	TRUE	TRUE	FALSE	3.13	7.90	5.23	60%	40%	66%		1.51	5.9	5.5									12,712	13,628				12,656	13,608		
12/25/2017	TRUE	TRUE	FALSE	3.08	6.29	4.62	67%	49%	73%		1.36	5.9	5.4									12,712	13,628				12,656	13,608		
12/26/2017	TRUE	TRUE	FALSE	3.08	7.27	5.17	60%	42%	71%		1.41	5.9	5.3									12,712	13,628				12,656	13,608		
12/27/2017	TRUE	TRUE	FALSE	3.16	7.15	5.38	59%	44%	75%		1.33	5.8	5.3									12,712	13,628				12,656	13,608		
12/28/2017	TRUE	TRUE	FALSE	3.16	7.38	5.43	58%	43%	74%		1.36	5.8	5.3	261.70	339.00	1.30		11,851	15,352			12,605	13,843	11,851	15,352		12,555	13,826		
12/29/2017	TRUE	TRUE	FALSE	3.13	7.33	5.35	59%	43%	73%		1.37	5.8	5.3									12,605	13,843				12,555	13,826		
12/30/2017	TRUE	TRUE	FALSE	3.10	7.44	5.27	59%	42%	71%		1.41	5.7	5.2									12,888	14,067				12,832	14,047		
12/31/2017	TRUE	TRUE	FALSE	3.01	7.76	5.31	57%	39%	68%		1.46	5.7	5.2									12,916	14,415				12,850	14,392		
1/1/2018	TRUE	TRUE	FALSE	3.06	6.98	4.99	61%	44%	71%		1.40	5.6	5.2									12,916	14,415				12,850	14,392		
1/2/2018	TRUE	TRUE	FALSE	2.99	7.30	5.35	56%	41%	73%		1.36	5.6	5.3									12,916	14,415				12,850	14,392		
1/3/2018	TRUE	TRUE	FALSE	3.11	7.33	5.42	57%	42%	74%		1.35	5.6	5.3	278.30				12,580				12,868	14,415	12,580			12,812	14,392		
1/4/2018	TRUE	TRUE	TRUE	3.13	7.24	5.48	57%	43%	76%		1.32	5.6	5.3	255.70	280.00	1.10		11,686	12,797			12,720	14,184	11,686	12,797		12,671	14,164		
1/5/2018	TRUE	TRUE	TRUE	3.14	7.51	5.52	57%	42%	74%		1.36	5.6	5.3									12,720	14,184				12,671	14,164		
1/6/2018	TRUE	TRUE	TRUE	3.12	7.73	5.49	57%	40%	71%		1.41	5.5	5.4									12,627	13,487				12,571	13,464		
1/7/2018	TRUE	TRUE	FALSE	3.02	7.87	5.56	54%	38%	71%		1.42	5.5	5.4									12,715	13,358				12,649	13,331		
1/8/2018	TRUE	TRUE	TRUE	3.06	10.98	6.65	46%	28%	61%		1.65	5.5	5.6									12,715	13,358				12,649	13,331		
1/9/2018	TRUE	TRUE	TRUE	7.70	11.66	9.80	79%	66%	84%	inAvgMinM	1.19	5.5	5.6									12,715	13,358				12,649	13,331		
1/10/2018	TRUE	TRUE	TRUE	4.22	10.62	7.41	57%	40%	70%		1.43	5.6	5.9	176.70	217.00	1.23		10,920	13,410			12,459	13,367	10,920	13,410		12,402	13,344		
1/11/2018	TRUE	TRUE	FALSE	3.64	9.46	6.77	54%	38%	72%		1.40	5.6	6.1	167.60	192.00	1.15		9,463	10,841			12,084	13,006	9,302	10,772		12,015	12,976		
1/12/2018	TRUE	TRUE	FALSE	3.35	8.77	6.29	53%	38%	72%		1.39	5.6	6.2									12,084	13,006				12,015	12,976		
1/13/2018	TRUE	TRUE	FALSE	3.29	8.46	6.06	54%	39%	72%		1.40	5.6	6.3									11,969	12,956				11,890	12,922		
1/14/2018	TRUE	TRUE	FALSE	3.25	8.67	5.90	55%	37%	68%		1.47	5.6	6.4									11,510	13,021				11,484	13,007		
1/15/2018	TRUE	TRUE	TRUE	3.18	8.59	6.09	52%	37%	71%		1.41	5.6	6.5									11,510	13,021				11,484	13,007		
1/16/2018	TRUE	TRUE	TRUE	3.37	8.44	6.14	55%	40%	73%		1.37	5.7	6.4									11,510	13,021				11,484	13,007		
1/17/2018	TRUE	TRUE	FALSE	3.35	8.65	6.13	55%	39%	71%		1.41	5.7	6.3	219.40	283.00	1.29		11,217	14,468			11,468	13,262	11,217	14,468		11,445	13,251		
1/18/2018	TRUE	TRUE	TRUE	3.28	8.29	6.10	54%	40%	74%		1.36	5.7	6.2	237.80	359.00	1.51		12,098	18,264			11,547	13,977	12,098	18,264		11,527	13,967		
1/19/2018	TRUE	TRUE	FALSE	3.38	8.24	6.17	55%	41%	75%		1.34	5.7	6.1									11,547	13,977				11,527	13,967		
1/20/2018	TRUE	TRUE	FALSE	3.25	8.81	6.08	53%	37%	69%		1.45	5.7	6.1									11,547	13,977				11,527	13,967		
1/21/2018	TRUE	TRUE	TRUE	3.26	9.70	6.24	52%	34%	64%		1.55	5.8	6.1									11,402	14,189				11,379	14,177		
1/22/2018	TRUE	TRUE	TRUE	3.43	9.80	7.09	48%	35%	72%		1.38	5.8	6.3									11,402	14,189				11,379	14,177		
1/23/2018	FALSE	FALSE	FALSE	3.57	9.94	6.99	51%	36%	70%		1.42	5.9	6.4									11,402	14,189				11,379	14,177		
1/24/2018	FALSE	FALSE	TRUE	3.42	9.52	6.85	50%	36%	72%		1.39	5.9	6.5	209.70	256.00	1.22		11,980	14,625			11,474	14,251	11,980	14,625		11,454	14,241		
1/25/2018	FALSE	FALSE	FALSE	3.43	9.53	6.85	50%	36%	72%		1.39	6.0	6.5	190.70	290.00	1.52		10,895	16,567			11,410	14,541	10,895	16,567		11,392	14,532		
1/26/2018	FALSE	FALSE	FALSE	3.48	9.16	6.60	53%	38%	72%		1.39	6.0	6.6									11,410	14,541				11,392	14,532		
1/27/2018	FALSE	FALSE	FALSE	3.40	9.88	6.48	52%	34%	66%		1.52	6.1	6.6									11,410	14,541				11,392	14,532		
1/28/2018	FALSE	FALSE	FALSE	3.31	9.39	6.40	52%	35%	68%		1.47	6.1	6.7									11,355	14,425				11,335	14,415		
1/29/2018	FALSE	FALSE	FALSE	3.24	8.96	6.36	51%	36%	71%		1.41	6.1	6.7									11,355	14,425				11,335	14,415		
1/30/2018	FALSE	FALSE	FALSE	3.21	9.00	6.30	51%	36%	70%		1.43	6.2	6.6									11,355	14,425				11,335	14,415		
1/31/2018	FALSE	FALSE	FALSE	3.20	8.99	6.23	51%	36%	69%		1.44	6.2	6.5	301.50	381.00	1.26		15,665	19,796		BOD	11,834	14,425	15,665	19,796		11,816	14,415		
2/1/2018	FALSE	FALSE	FALSE	3.33	8.62	6.17	54%	39%	72%		1.40	6.2	6.4	234.70				12,077				11,858	14,425	12,077			11,842	14,415		
2/2/2018	FALSE	FALSE	FALSE	3.25	8.48	6.07	54%	38%	72%		1.40	6.3	6.3									11,858	14,425				11,842	14,415		
2/3/2018	FALSE	FALSE	FALSE	3.24	9.07	6.02	54%	36%	66%		1.51	6.3	6.3									11,778	14,425				11,760	14,415		
2/4/2018	FALSE	FALSE	FALSE	3.19	9.60	6.00	53%	33%	63%		1.60	6.3	6.2									11,789	14,696				11,769	14,684		
2/5/2018	FALSE	FALSE	FALSE	3.18	8.39	6.04	53%	38%	72%		1.39	6.3	6.1									11,789	14,696				11,769	14,684		
2/6/2018	FALSE	FALSE	FALSE	3.24	8.53	6.01	54%	38%	70%		1.42	6.3	6.1									11,789	14,696				11,769	14,684		
2/7/2018	FALSE	FALSE	FALSE	3.24	8.78	6.04	54%	37%	69%		1.45	6.4	6.1									11,789	14,696				11,769	14,684		
2/8/2018	FALSE	FALSE	FALSE	3.29	8.43	5.98	5																							

Date	Butte Break?	CSU Break?	Precip?	Min Influent Flow, mgd	Max Influent Flow, mgd	Avg Influent Flow, mgd	Min % of Avg	Min % of Max	Avg % of Max	Flow Outlier Type	Diurnal Peak Factor (DPF)	30-d Avg of Avg Flow, mgd	7-d Avg of Avg Flow, mgd	Influent TSS Conc., mg/L	Influent BOD Conc., mg/L	BOD/TSS Ratio	Influent NH3-N Conc., mg/L	Avg Inf TSS Load, ppd	Avg Inf BOD Load, ppd	Avg Inf NH3 Load, ppd	Load Outlier Type	30-d Avg of TSS Load, ppd	30-d Avg of BOD Load, ppd	30-d Avg of NH3-N Load, ppd	non-SN TSS Load, ppd	non-SN BOD Load, ppd	non-SN NH3 Load, ppd	30-d Avg of non-SN TSS Load, ppd	30-d Avg of non-SN BOD Load, ppd	30-d Avg of non-SN NH3-N Load, ppd
2/16/2018	FALSE	FALSE	FALSE	3.11	8.11	5.84	53%	38%	72%		1.39	6.2	5.9	257.20	277.00	1.08		12,527	13,491			12,587	14,942		12,527	13,491		12,587	14,942	
2/17/2018	FALSE	FALSE	FALSE	3.18	8.57	5.76	55%	37%	67%		1.49	6.2	5.9									12,739	15,010					12,739	15,010	
2/18/2018	FALSE	FALSE	FALSE	3.16	8.86	5.72	55%	36%	65%		1.55	6.2	5.9									12,820	14,468					12,820	14,468	
2/19/2018	FALSE	FALSE	FALSE	3.07	8.64	5.97	51%	36%	69%		1.45	6.2	5.9									12,820	14,468					12,820	14,468	
2/20/2018	FALSE	FALSE	FALSE	3.07	8.53	5.95	52%	36%	70%		1.43	6.2	5.9									12,820	14,468					12,820	14,468	
2/21/2018	FALSE	FALSE	FALSE	3.14	8.30	5.93	53%	38%	71%		1.40	6.2	5.9	253.70	293.00	1.15		12,547	14,491			12,789	14,471		12,547	14,491		12,789	14,471	
2/22/2018	FALSE	FALSE	FALSE	3.42	8.40	6.01	57%	41%	72%		1.40	6.1	5.9	267.20	268.00	1.00		13,393	13,433			12,850	14,341		13,393	13,433		12,850	14,341	
2/23/2018	FALSE	FALSE	FALSE	3.32	8.20	5.89	56%	40%	72%		1.39	6.1	5.9									12,850	14,341					12,850	14,341	
2/24/2018	FALSE	FALSE	FALSE	3.33	8.96	5.86	57%	37%	65%		1.53	6.1	5.9									12,946	14,301					12,946	14,301	
2/25/2018	FALSE	FALSE	FALSE	3.29	8.83	5.96	55%	37%	67%		1.48	6.0	5.9									13,203	13,923					13,203	13,923	
2/26/2018	FALSE	FALSE	FALSE	3.36	8.34	5.96	56%	40%	71%		1.40	6.0	5.9									13,203	13,923					13,203	13,923	
2/27/2018	FALSE	FALSE	FALSE	3.14	8.35	5.92	53%	38%	71%		1.41	6.0	5.9									13,203	13,923					13,203	13,923	
2/28/2018	FALSE	FALSE	FALSE	3.17	8.77	5.98	53%	36%	68%		1.47	6.0	5.9	266.10				13,271				13,210	13,923		13,271			13,210	13,923	
3/1/2018	FALSE	FALSE	TRUE	3.54	9.12	6.75	52%	39%	74%		1.35	6.0	6.0	262.20	287.00	1.09		14,761	16,157			13,365	14,242		14,761	16,157		13,365	14,242	
3/2/2018	FALSE	FALSE	FALSE	3.50	9.20	6.65	53%	38%	72%		1.38	6.0	6.1									13,365	14,242					13,365	14,242	
3/3/2018	FALSE	FALSE	FALSE	3.39	9.70	6.43	53%	35%	66%		1.51	6.0	6.2									13,110	14,242					13,110	14,242	
3/4/2018	FALSE	FALSE	FALSE	3.30	9.56	6.25	53%	35%	65%		1.53	6.0	6.2									13,239	14,242					13,239	14,242	
3/5/2018	FALSE	FALSE	FALSE	3.21	8.67	6.22	52%	37%	72%		1.39	6.0	6.3									13,239	14,242					13,239	14,242	
3/6/2018	FALSE	FALSE	FALSE	3.25	8.80	6.26	52%	37%	71%		1.41	6.0	6.3									13,239	14,242					13,239	14,242	
3/7/2018	FALSE	FALSE	TRUE	3.40	8.74	6.27	54%	39%	72%		1.39	6.0	6.4	237.20	237.00	1.00		12,404	12,393			13,146	14,011		12,404	12,393		13,146	14,011	
3/8/2018	FALSE	FALSE	TRUE	3.53	8.53	6.40	55%	41%	75%		1.33	6.0	6.4	245.70	256.00	1.04		13,114	13,664			13,143	13,972		13,114	13,664		13,143	13,972	
3/9/2018	FALSE	FALSE	FALSE	3.49	8.78	6.31	55%	40%	72%		1.39	6.1	6.3									13,143	13,972					13,143	13,972	
3/10/2018	FALSE	FALSE	FALSE	3.45	9.12	6.23	55%	38%	68%		1.46	6.1	6.3									13,143	13,972					13,143	13,972	
3/11/2018	FALSE	FALSE	FALSE	3.44	8.98	6.23	55%	38%	69%		1.44	6.1	6.3									12,960	13,811					12,960	13,811	
3/12/2018	FALSE	FALSE	TRUE	3.36	8.76	6.25	54%	38%	71%		1.40	6.1	6.3									13,060	13,920					13,060	13,920	
3/13/2018	FALSE	FALSE	TRUE	3.51	9.47	6.89	51%	37%	73%		1.37	6.1	6.4									13,060	13,920					13,060	13,920	
3/14/2018	FALSE	FALSE	TRUE	3.63	9.30	7.18	51%	39%	77%		1.30	6.2	6.5									13,060	13,920					13,060	13,920	
3/15/2018	FALSE	FALSE	TRUE	3.61	9.84	7.31	49%	37%	74%		1.35	6.2	6.6									13,060	13,920					13,060	13,920	
3/16/2018	TRUE	TRUE	FALSE	3.87	9.59	7.17	54%	40%	75%		1.34	6.2	6.7	182.40	216.00	1.18		10,907	12,916			12,821	13,794		10,907	12,916		12,821	13,794	
3/17/2018	TRUE	TRUE	FALSE	3.61	8.97	6.53	55%	40%	73%		1.37	6.3	6.7									12,821	13,794					12,821	13,794	
3/18/2018	TRUE	TRUE	FALSE	3.33	8.25	6.05	55%	40%	73%		1.36	6.3	6.7									12,866	13,792					12,866	13,792	
3/19/2018	TRUE	TRUE	FALSE	3.23	7.58	5.88	55%	43%	78%		1.29	6.3	6.7	62.00				3,040			TSS	12,914	13,842		3,040			12,914	13,842	
3/20/2018	TRUE	TRUE	TRUE	3.18	8.00	5.92	54%	40%	74%		1.35	6.3	6.6									12,914	13,842					12,914	13,842	
3/21/2018	TRUE	TRUE	TRUE	3.89	10.84	7.95	49%	36%	73%		1.36	6.3	6.7	227.70	248.00	1.09		15,097	16,443			13,187	14,214		15,097	16,443		13,187	14,214	
3/22/2018	TRUE	TRUE	TRUE	5.47	11.50	9.38	58%	48%	82%		1.23	6.5	7.0	183.60	157.00	0.86		14,363	12,282			13,317	13,972		14,228	12,229		13,302	13,966	
3/23/2018	TRUE	TRUE	FALSE	5.00	10.31	8.03	62%	48%	78%		1.28	6.5	7.1									13,317	13,972					13,302	13,966	
3/24/2018	TRUE	TRUE	TRUE	4.30	9.60	7.24	59%	45%	75%		1.33	6.6	7.1									13,414	13,898					13,397	13,891	
3/25/2018	TRUE	TRUE	FALSE	3.33	9.65	7.05	47%	35%	73%		1.37	6.6	7.2									13,417	13,976					13,397	13,967	
3/26/2018	TRUE	TRUE	FALSE	3.39	9.34	7.00	48%	36%	75%		1.33	6.6	7.3									13,417	13,976					13,397	13,967	
3/27/2018	FALSE	FALSE	FALSE	3.50	9.66	6.79	52%	36%	70%		1.42	6.7	7.4									13,417	13,976					13,397	13,967	
3/28/2018	FALSE	FALSE	FALSE	3.42	9.79	6.69	51%	35%	68%		1.46	6.7	7.5	193.90	233.00	1.20		10,819	13,000			13,092	13,837		10,819	13,000		13,075	13,829	
3/29/2018	FALSE	FALSE	FALSE	3.55	9.38	6.63	54%	38%	71%		1.41	6.7	7.4	202.80	227.00	1.12		11,214	12,552			12,883	13,676		11,214	12,552		12,868	13,669	
3/30/2018	FALSE	FALSE	FALSE	3.41	9.17	6.48	53%	37%	71%		1.42	6.7	7.0									12,883	13,676					12,868	13,669	
3/31/2018	FALSE	FALSE	FALSE	3.31	9.32	6.20	53%	36%	67%		1.50	6.7	6.8									12,835	13,676					12,818	13,669	
4/1/2018	FALSE	FALSE	FALSE	3.28	8.91	6.00	55%	37%	67%		1.49	6.7	6.6									12,560	13,322					12,540	13,314	
4/2/2018	FALSE	FALSE	FALSE	3.27	8.55	6.29	52%	38%	74%		1.36	6.7	6.5									12,560	13,322					12,540	13,314	
4/3/2018	FALSE	FALSE	FALSE	3.29	9.23	6.26	53%	36%	68%		1.47	6.7	6.4									12,560	13,322					12,540	13,314	
4/4/2018	FALSE	FALSE	FALSE	3.24	8.81	6.22	52%	37%	71%		1.42	6.7	6.3									12,560	13,322					12,540	13,314	
4/5/2018	FALSE	FALSE	TRUE	3.26	8.79	6.25	52%	37%	71%		1.41	6.7	6.3									12,560	13,322					12,540	13,314	
4/6/2018	FALSE	FALSE	TRUE	3.38	13.29	8.58	39%	25%	65%	MinAvg	1.55	6.7	6.2									12,560	13,322					12,540	13,314	
4/7/2018	FALSE	FALSE	TRUE	9.97	16.01	12.25	81%	62%	77%	inAvgMinM	1.31	6.7	6.2									12,586	13,476					12,563	13,467	
4/8/2018	FALSE	FALSE	FALSE	5.68	12.10	9.06	63%	47%	75%		1.34	6.8	6.7									12,480	13,439					12,453	13,428	
4/9/2018	FALSE	FALSE	FALSE	4.43	11.10	8.17	54%	40%	74%		1.36	6.9	7.0									12,480	13,439					12,453	13,428	
4/10/2018	FALSE	FALSE	TRUE	4.27	10.94	7.64	56%	39%	70%		1.43	6.9	7.3									12,480	13,439					12,453	13,428	
4/11/2018																														

Date	Butte Break?	CSU Break?	Precip?	Min Influent Flow, mgd	Max Influent Flow, mgd	Avg Influent Flow, mgd	Min % of Avg	Min % of Max	Avg % of Max	Flow Outlier Type	Diurnal Peak Factor (DPF)	30-d Avg of Avg Flow, mgd	7-d Avg of Avg Flow, mgd	Influent TSS Conc., mg/L	Influent BOD Conc., mg/L	BOD/TSS Ratio	Influent NH3-N Conc., mg/L	Avg Inf TSS Load, ppd	Avg Inf BOD Load, ppd	Avg Inf NH3 Load, ppd	Load Outlier Type	30-d Avg of TSS Load, ppd	30-d Avg of BOD Load, ppd	30-d Avg of NH3-N Load, ppd	non-SN TSS Load, ppd	non-SN BOD Load, ppd	non-SN NH3 Load, ppd	30-d Avg of non-SN TSS Load, ppd	30-d Avg of non-SN BOD Load, ppd	30-d Avg of non-SN NH3-N Load, ppd
4/20/2018	FALSE	FALSE	FALSE	3.41	8.97	6.34	54%	38%	71%		1.41	7.0	6.7									12,873	13,569	1,108				12,839	13,556	1,108
4/21/2018	FALSE	FALSE	FALSE	3.36	8.79	6.07	55%	38%	69%		1.45	6.9	6.6									12,132	12,611	1,108				12,087	12,594	1,108
4/22/2018	FALSE	FALSE	FALSE	3.28	8.92	6.12	54%	37%	69%		1.46	6.8	6.6									11,016	12,776	1,108				11,016	12,776	1,108
4/23/2018	FALSE	FALSE	FALSE	3.22	9.18	6.17	52%	35%	67%		1.49	6.8	6.5									11,016	12,776	1,108				11,016	12,776	1,108
4/24/2018	FALSE	FALSE	FALSE	3.25	8.84	6.18	53%	37%	70%		1.43	6.7	6.4				22.50			1,160		11,016	12,776	1,134		1,160		11,016	12,776	1,134
4/25/2018	FALSE	FALSE	FALSE	3.22	8.96	6.09	53%	36%	68%		1.47	6.7	6.3				33.00			1,676		11,016	12,776	1,315		1,676		11,016	12,776	1,315
4/26/2018	FALSE	FALSE	FALSE	3.24	8.86	6.08	53%	37%	69%		1.46	6.7	6.2				34.00			1,724		11,016	12,776	1,417		1,724		11,016	12,776	1,417
4/27/2018	FALSE	FALSE	FALSE	3.26	8.63	6.06	54%	38%	70%		1.42	6.6	6.1									11,016	12,776	1,417				11,016	12,776	1,417
4/28/2018	FALSE	FALSE	FALSE	3.20	8.80	5.91	54%	36%	67%		1.49	6.6	6.1									11,214	12,552	1,417				11,214	12,552	1,417
4/29/2018	FALSE	FALSE	FALSE	3.13	8.48	5.81	54%	37%	69%		1.46	6.6	6.1											1,417						1,417
4/30/2018	FALSE	FALSE	FALSE	3.11	8.63	5.95	52%	36%	69%		1.45	6.6	6.0											1,417						1,417
5/1/2018	FALSE	FALSE	FALSE	3.20	8.71	5.91	54%	37%	68%		1.47	6.6	6.0											1,417						1,417
5/2/2018	FALSE	FALSE	FALSE	3.26	8.53	6.00	54%	38%	70%		1.42	6.6	6.0	208.80	235.00	1.13	38.50	10,448	11,759	1,927		10,448	11,759	1,519	10,448	11,759	1,927	10,448	11,759	1,519
5/3/2018	FALSE	FALSE	FALSE	3.25	8.63	5.96	55%	38%	69%		1.45	6.5	6.0	231.00	248.00	1.07	36.80	11,482	12,327	1,829		10,965	12,043	1,571	11,482	12,327	1,829	10,965	12,043	1,571
5/4/2018	FALSE	FALSE	FALSE	3.24	8.29	5.98	54%	39%	72%		1.39	6.5	5.9									10,965	12,043	1,571				10,965	12,043	1,571
5/5/2018	FALSE	FALSE	FALSE	3.27	8.26	5.93	55%	40%	72%		1.39	6.5	5.9									10,965	12,043	1,571				10,965	12,043	1,571
5/6/2018	FALSE	FALSE	FALSE	3.25	8.10	5.80	56%	40%	72%		1.40	6.5	5.9									10,965	12,043	1,571				10,965	12,043	1,571
5/7/2018	FALSE	FALSE	FALSE	3.11	8.62	5.84	53%	36%	68%		1.48	6.5	5.9									10,965	12,043	1,571				10,965	12,043	1,571
5/8/2018	FALSE	FALSE	FALSE	3.26	8.33	5.86	56%	39%	70%		1.42	6.5	5.9									10,965	12,043	1,571				10,965	12,043	1,571
5/9/2018	FALSE	FALSE	FALSE	3.22	8.80	5.97	54%	37%	68%		1.47	6.4	5.9	322.70	299.00	0.93	40.30	16,067	14,887	2,007		12,666	12,991	1,633	16,067	14,887	2,007	12,666	12,991	1,633
5/10/2018	FALSE	FALSE	FALSE	3.23	8.56	5.92	55%	38%	69%		1.45	6.3	5.9	264.70	284.00	1.07	39.00	13,069	14,022	1,926		12,767	13,249	1,669	13,069	14,022	1,926	12,767	13,249	1,669
5/11/2018	FALSE	FALSE	FALSE	3.19	8.24	5.84	55%	39%	71%		1.41	6.2	5.9									12,767	13,249	1,669				12,767	13,249	1,669
5/12/2018	FALSE	FALSE	FALSE	3.26	8.36	5.69	57%	39%	68%		1.47	6.2	5.9									12,767	13,249	1,669				12,767	13,249	1,669
5/13/2018	FALSE	FALSE	FALSE	3.16	8.30	5.66	56%	38%	68%		1.47	6.1	5.8									12,767	13,249	1,669				12,767	13,249	1,669
5/14/2018	FALSE	FALSE	FALSE	3.17	8.23	5.87	54%	39%	71%		1.40	6.1	5.8									12,767	13,249	1,669				12,767	13,249	1,669
5/15/2018	FALSE	FALSE	FALSE	3.22	8.53	5.93	54%	38%	70%		1.44	6.1	5.8									12,767	13,249	1,669				12,767	13,249	1,669
5/16/2018	FALSE	FALSE	FALSE	3.27	8.41	5.97	55%	39%	71%		1.41	6.1	5.9	300.60	303.00	1.01	42.30	14,967	15,086	2,106	NH3	13,207	13,616	1,669	14,967	15,086	2,106	13,207	13,616	1,669
5/17/2018	FALSE	FALSE	FALSE	3.21	8.23	5.82	55%	39%	71%		1.41	6.0	5.8	277.10	298.00	1.08	38.80	13,450	14,465	1,883		13,247	13,758	1,693	13,450	14,465	1,883	13,247	13,758	1,693
5/18/2018	FALSE	FALSE	FALSE	3.25	8.46	5.94	55%	38%	70%		1.42	6.0	5.8									13,247	13,758	1,693				13,247	13,758	1,693
5/19/2018	FALSE	FALSE	FALSE	3.28	8.18	5.75	57%	40%	70%		1.42	6.0	5.8									13,247	13,758	1,766				13,247	13,758	1,766
5/20/2018	FALSE	TRUE	FALSE	3.18	8.13	5.66	56%	39%	70%		1.44	5.9	5.8									13,247	13,758	1,766				13,247	13,758	1,766
5/21/2018	FALSE	TRUE	FALSE	3.20	8.20	5.61	57%	39%	68%		1.46	5.9	5.8									13,247	13,758	1,766				13,247	13,758	1,766
5/22/2018	FALSE	TRUE	FALSE	3.26	7.81	5.53	59%	42%	71%		1.41	5.9	5.8									13,247	13,758	1,766				13,247	13,758	1,766
5/23/2018	FALSE	TRUE	FALSE	3.19	7.87	5.54	58%	41%	70%		1.42	5.9	5.7									13,247	13,758	1,766				13,247	13,758	1,766
5/24/2018	FALSE	TRUE	FALSE	3.20	7.80	5.52	58%	41%	71%		1.41	5.9	5.7	400.00	317.00	0.79	45.50	18,415	14,594	2,095	NH3	13,985	13,877	1,766	18,415	14,594	2,095	13,985	13,877	1,766
5/25/2018	TRUE	TRUE	TRUE	3.18	7.68	5.75	55%	41%	75%		1.34	5.8	5.7	323.30	441.00	1.36	34.70	15,504	21,148	1,664	BOD	14,175	13,877	1,829	15,504	21,148	1,664	14,175	13,877	1,829
5/26/2018	TRUE	TRUE	TRUE	3.22	7.82	5.35	60%	41%	68%		1.46	5.8	5.6									14,175	13,877	1,851				14,175	13,877	1,851
5/27/2018	TRUE	TRUE	FALSE	3.14	7.19	5.08	62%	44%	71%		1.42	5.8	5.5									14,175	13,877	1,873				14,175	13,877	1,873
5/28/2018	TRUE	TRUE	FALSE	3.20	7.29	5.26	61%	44%	72%		1.39	5.8	5.5									14,175	13,877	1,873				14,175	13,877	1,873
5/29/2018	TRUE	TRUE	FALSE	3.21	7.71	5.40	59%	42%	70%		1.43	5.7	5.4									14,175	13,877	1,873				14,175	13,877	1,873
5/30/2018	TRUE	TRUE	FALSE	3.27	7.84	5.51	59%	42%	70%		1.42	5.7	5.4	247.60	367.00	1.48	37.70	11,378	16,865	1,732		13,864	14,251	1,853	11,256	16,833	1,732	13,851	14,247	1,853
5/31/2018	TRUE	TRUE	FALSE	3.19	8.10	5.48	58%	39%	68%		1.48	5.7	5.4	261.00	344.00	1.32	37.10	11,929	15,722	1,696		13,671	14,414	1,833	11,929	15,722	1,696	13,659	14,411	1,833
6/1/2018	TRUE	TRUE	FALSE	3.20	7.68	5.39	59%	42%	70%		1.42	5.7	5.4									13,671	14,414	1,833				13,659	14,411	1,833
6/2/2018	TRUE	TRUE	FALSE	3.21	7.45	5.21	62%	43%	70%		1.43	5.7	5.3									14,029	14,746	1,820				14,015	14,742	1,820
6/3/2018	TRUE	TRUE	FALSE	3.16	7.11	5.15	61%	44%	72%		1.38	5.7	5.3									14,347	15,091	1,818				14,332	15,087	1,818
6/4/2018	TRUE	TRUE	FALSE	3.16	7.67	5.40	59%	41%	70%		1.42	5.6	5.4									14,347	15,091	1,818				14,332	15,087	1,818
6/5/2018	TRUE	TRUE	FALSE	3.22	7.55	5.33	60%	43%	71%		1.42	5.6	5.4									14,347	15,091	1,818				14,332	15,087	1,818
6/6/2018	TRUE	TRUE	FALSE	3.13	7.39	5.35	59%	42%	72%		1.38	5.6	5.4	271.30	273.00	1.01	40.90	12,105	12,181	1,825		14,098	14,728	1,819	12,105	12,181	1,825	14,085	14,724	1,819
6/7/2018	TRUE	TRUE	FALSE	3.15	7.31	5.37	59%	43%	73%		1.36	5.6	5.3	264.50	264.00	1.00	38.10	11,846	11,823	1,706		13,873	14,405	1,805	11,846	11,823	1,706	13,861	14,401	1,805
6/8/2018	TRUE	TRUE	FALSE	3.15	6.85	5.24	60%	46%	76%		1.31	5.6	5.3									13,629	14,345	1,776				13,616	14,341	1,776
6/9/2018	TRUE	TRUE	FALSE	3.12	7.23	5.19	60%	43%																						

Date	Butte Break?	CSU Break?	Precip?	Min Influent Flow, mgd	Max Influent Flow, mgd	Avg Influent Flow, mgd	Min % of Avg	Min % of Max	Avg % of Max	Flow Outlier Type	Diurnal Peak Factor (DPF)	30-d Avg of Avg Flow, mgd	7-d Avg of Avg Flow, mgd	Influent TSS Conc., mg/L	Influent BOD Conc., mg/L	BOD/TSS Ratio	Influent NH3-N Conc., mg/L	Avg Inf TSS Load, ppd	Avg Inf BOD Load, ppd	Avg Inf NH3 Load, ppd	Load Outlier Type	30-d Avg of TSS Load, ppd	30-d Avg of BOD Load, ppd	30-d Avg of NH3-N Load, ppd	non-SN TSS Load, ppd	non-SN BOD Load, ppd	non-SN NH3 Load, ppd	30-d Avg of non-SN TSS Load, ppd	30-d Avg of non-SN BOD Load, ppd	30-d Avg of non-SN NH3-N Load, ppd
6/22/2018	TRUE	TRUE	FALSE	3.19	7.01	5.19	61%	46%	74%		1.35	5.3	5.2									13,326	13,293	1,719				13,303	13,286	1,719
6/23/2018	TRUE	TRUE	FALSE	3.20	6.99	5.02	64%	46%	72%		1.39	5.3	5.2									13,326	13,293	1,719				13,303	13,286	1,719
6/24/2018	TRUE	TRUE	FALSE	3.14	6.82	4.96	63%	46%	73%		1.38	5.3	5.2									12,760	13,131	1,719				12,735	13,123	1,719
6/25/2018	TRUE	TRUE	FALSE	3.19	6.88	5.26	61%	46%	76%		1.31	5.2	5.2									12,417	13,131	1,728				12,389	13,123	1,728
6/26/2018	TRUE	TRUE	FALSE	3.20	7.37	5.30	60%	43%	72%		1.39	5.2	5.2									12,417	13,131	1,728				12,389	13,123	1,728
6/27/2018	TRUE	TRUE	FALSE	3.17	7.31	5.27	60%	43%	72%		1.39	5.2	5.2	377.00	246.00	0.65		16,570	10,812			12,879	12,873	1,728	16,570	10,812		12,853	12,866	1,728
6/28/2018	TRUE	TRUE	FALSE	3.22	7.15	5.28	61%	45%	74%		1.35	5.2	5.2	251.10	234.00	0.93		11,057	10,304			12,697	12,616	1,728	11,057	10,304		12,674	12,610	1,728
6/29/2018	TRUE	TRUE	FALSE	3.20	7.14	5.23	61%	45%	73%		1.37	5.2	5.2									12,697	12,616	1,728				12,674	12,610	1,728
6/30/2018	TRUE	TRUE	FALSE	3.20	7.10	5.05	63%	45%	71%		1.41	5.2	5.2									12,843	12,144	1,728				12,831	12,141	1,728
7/1/2018	TRUE	TRUE	FALSE	3.15	6.81	4.88	65%	46%	72%		1.40	5.2	5.2									12,957	11,697	1,736				12,944	11,693	1,736
7/2/2018	TRUE	TRUE	FALSE	3.13	6.84	5.17	61%	46%	76%		1.32	5.2	5.2									12,957	11,697	1,736				12,944	11,693	1,736
7/3/2018	TRUE	TRUE	FALSE	3.22	7.13	5.14	63%	45%	72%		1.39	5.2	5.2									12,957	11,697	1,736				12,944	11,693	1,736
7/4/2018	TRUE	TRUE	FALSE	3.14	6.89	4.80	65%	46%	70%		1.44	5.2	5.1									12,957	11,697	1,736				12,944	11,693	1,736
7/5/2018	TRUE	TRUE	FALSE	3.12	6.65	4.87	64%	47%	73%		1.37	5.2	5.1	207.70	212.00	1.02		8,436	8,611			12,455	11,354	1,736	8,436	8,611		12,443	11,351	1,736
7/6/2018	TRUE	TRUE	FALSE	3.10	6.94	5.12	61%	45%	74%		1.36	5.2	5.0									12,455	11,354	1,736				12,443	11,351	1,736
7/7/2018	TRUE	TRUE	FALSE	3.21	7.03	5.00	64%	46%	71%		1.41	5.2	5.0									12,499	11,251	1,706				12,486	11,247	1,706
7/8/2018	TRUE	TRUE	FALSE	3.14	6.80	4.98	63%	46%	73%		1.37	5.1	5.0									12,592	11,169	1,705				12,577	11,164	1,705
7/9/2018	TRUE	TRUE	FALSE	3.15	7.07	5.21	60%	45%	74%		1.36	5.1	5.0									12,592	11,169	1,705				12,577	11,164	1,705
7/10/2018	TRUE	TRUE	FALSE	3.25	7.25	5.25	62%	45%	72%		1.38	5.1	5.0									12,592	11,169	1,705				12,577	11,164	1,705
7/11/2018	TRUE	TRUE	FALSE	3.17	7.17	5.21	61%	44%	73%		1.38	5.1	5.1	268.10	175.00	0.65		11,649	7,604			12,474	10,723	1,705	11,649	7,604		12,461	10,719	1,705
7/12/2018	TRUE	TRUE	FALSE	3.20	7.33	5.24	61%	44%	71%		1.40	5.1	5.1	277.00	190.00	0.69		12,105	8,303			12,433	10,454	1,705	12,105	8,303		12,421	10,451	1,705
7/13/2018	TRUE	TRUE	FALSE	3.17	6.94	5.20	61%	46%	75%		1.33	5.1	5.2									12,433	10,454	1,705				12,421	10,451	1,705
7/14/2018	TRUE	TRUE	FALSE	3.25	7.06	5.01	65%	46%	71%		1.41	5.1	5.1									12,409	10,354	1,699				12,396	10,351	1,699
7/15/2018	TRUE	TRUE	FALSE	3.13	6.95	4.99	63%	45%	72%		1.39	5.1	5.1									12,430	10,163	1,699				12,430	10,163	1,699
7/16/2018	TRUE	TRUE	FALSE	3.16	7.28	5.20	61%	43%	71%		1.40	5.1	5.2									12,430	10,163	1,699				12,430	10,163	1,699
7/17/2018	TRUE	TRUE	FALSE	3.22	7.14	5.26	61%	45%	74%		1.36	5.1	5.2									12,430	10,163	1,699				12,430	10,163	1,699
7/18/2018	TRUE	TRUE	FALSE	3.15	7.10	5.29	60%	44%	75%		1.34	5.143226	5.18	348.00	102.00	0.29		15,353	4,500			12,796	9,456	1,699	15,353	4,500		12,796	9,456	1,699
7/19/2018	TRUE	TRUE	FALSE	3.21	7.30	5.29	61%	44%	72%		1.38	5.144516	5.19	290.00	200.00	0.69		12,794	8,824			12,796	9,385	1,699	12,794	8,824		12,796	9,385	1,699
7/20/2018	TRUE	TRUE	FALSE	3.22	7.27	5.24	61%	44%	72%		1.39	5.143226	5.19									12,796	9,385	1,699				12,796	9,385	1,699
7/21/2018	TRUE	TRUE	FALSE	3.23	7.29	5.07	64%	44%	70%		1.44	5.137419	5.17									12,840	8,928					12,840	8,928	
7/22/2018	TRUE	TRUE	FALSE	3.13	7.11	5.04	62%	44%	71%		1.41	5.129677	5.17									12,566	8,423					12,566	8,423	
7/23/2018	TRUE	TRUE	FALSE	3.18	7.35	5.28	60%	43%	72%		1.39	5.132581	5.21									12,566	8,423					12,566	8,423	
7/24/2018	TRUE	TRUE	FALSE	3.26	7.40	5.41	60%	44%	73%		1.37	5.145161	5.24									12,566	8,423					12,566	8,423	
7/25/2018	TRUE	TRUE	FALSE	3.45	7.17	5.41	64%	48%	75%		1.33	5.159677	5.25	243.80	127.00	0.52		11,000	5,730			12,371	8,086		11,000	5,730		12,371	8,086	
7/26/2018	TRUE	TRUE	FALSE	3.38	7.12	5.33	63%	47%	75%		1.34	5.161935	5.26	260.00				11,558				12,280	8,086		11,558			12,280	8,086	
7/27/2018	TRUE	TRUE	FALSE	3.19	7.34	5.31	60%	43%	72%		1.38	5.162258	5.26									12,280	8,086					12,280	8,086	
7/28/2018	TRUE	TRUE	FALSE	3.25	7.14	5.19	63%	46%	73%		1.38	5.159677	5.26									11,744	7,697					11,744	7,697	
7/29/2018	TRUE	TRUE	FALSE	3.17	7.36	5.17	61%	43%	70%		1.42	5.156129	5.27									11,842	7,262					11,842	7,262	
7/30/2018	TRUE	TRUE	FALSE	3.19	7.26	5.45	59%	44%	75%		1.33	5.163226	5.32									11,842	7,262					11,842	7,262	
7/31/2018	TRUE	TRUE	FALSE	3.20	7.49	5.43	59%	43%	72%		1.38	5.175484	5.34									11,842	7,262					11,842	7,262	
8/1/2018	TRUE	TRUE	FALSE	3.24	7.34	5.40	60%	44%	74%		1.36	5.192258	5.34									11,842	7,262					11,842	7,262	
8/2/2018	TRUE	TRUE	FALSE	3.24	7.69	5.33	61%	42%	69%		1.44	5.197419	5.33									11,842	7,262					11,842	7,262	
8/3/2018	TRUE	TRUE	FALSE	3.21	7.07	5.33	60%	45%	75%		1.33	5.203548	5.33	259.50	125.00	0.48		11,535	5,557			11,804	7,018		11,535	5,557		11,804	7,018	
8/4/2018	TRUE	TRUE	FALSE	3.25	7.24	5.15	63%	45%	71%		1.41	5.214839	5.31									11,804	7,018					11,804	7,018	
8/5/2018	TRUE	TRUE	FALSE	3.17	7.40	5.17	61%	43%	70%		1.43	5.224516	5.30									12,285	6,753					12,285	6,753	
8/6/2018	TRUE	TRUE	FALSE	3.16	6.98	5.35	59%	45%	77%		1.30	5.231935	5.33									12,285	6,753					12,285	6,753	
8/7/2018	TRUE	TRUE	FALSE	3.18	7.42	5.32	60%	43%	72%		1.39	5.242258	5.31									12,285	6,753					12,285	6,753	
8/8/2018	TRUE	TRUE	FALSE	3.28	7.49	5.50	60%	44%	73%		1.36	5.259032	5.32	230.70	174.00	0.75		10,582	7,981			12,072	6,928		10,582	7,981		12,072	6,928	
8/9/2018	TRUE	TRUE	FALSE	3.24	7.42	5.42	60%	44%	73%		1.37	5.265806	5.32	243.20	121.00	0.50		10,993	5,470			11,952	6,746		10,993	5,470		11,952	6,746	
8/10/2018	TRUE	TRUE	FALSE	3.21	7.40	5.23	61%	43%	71%		1.41	5.265161	5.31									11,952	6,746					11,952	6,746	
8/11/2018	TRUE	TRUE	FALSE	3.20	7.38	5.18	62%	43%	70%		1.42	5.264194	5.29									11,990	6,624					11,990	6,624	
8/12/2018	TRUE	TRUE	FALSE	3.19	7.23	5.24	61%	44%	72%		1.38	5.264194	5.30									11,974	6,344					11,974	6,344	
8/13/2018	TRUE	TRUE	FALSE	3.16																										

Date	Butte Break?	CSU Break?	Precip?	Min Influent Flow, mgd	Max Influent Flow, mgd	Avg Influent Flow, mgd	Min % of Avg	Min % of Max	Avg % of Max	Flow Outlier Type	Diurnal Peak Factor (DPF)	30-d Avg of Avg Flow, mgd	7-d Avg of Avg Flow, mgd	Influent TSS Conc., mg/L	Influent BOD Conc., mg/L	BOD/TSS Ratio	Influent NH3-N Conc., mg/L	Avg Inf TSS Load, ppd	Avg Inf BOD Load, ppd	Avg Inf NH3 Load, ppd	Load Outlier Type	30-d Avg of TSS Load, ppd	30-d Avg of BOD Load, ppd	30-d Avg of NH3-N Load, ppd	non-SN TSS Load, ppd	non-SN BOD Load, ppd	non-SN NH3 Load, ppd	30-d Avg of non-SN TSS Load, ppd	30-d Avg of non-SN BOD Load, ppd	30-d Avg of non-SN NH3-N Load, ppd
8/23/2018	FALSE	TRUE	FALSE	3.26	8.63	5.87	56%	38%	68%		1.47	5.409032	5.62	247.20	193.00	0.78		12,102	9,448			11,663	7,745		12,102	9,448		11,663	7,745	
8/24/2018	FALSE	TRUE	FALSE	3.23	8.27	5.80	56%	39%	70%		1.43	5.421613	5.64									11,663	7,745					11,663	7,745	
8/25/2018	FALSE	TRUE	FALSE	3.25	8.50	5.73	57%	38%	67%		1.48	5.431935	5.68									11,745	8,033					11,745	8,033	
8/26/2018	FALSE	TRUE	FALSE	3.25	8.88	5.95	55%	37%	67%		1.49	5.451935	5.75									11,772	8,033					11,772	8,033	
8/27/2018	FALSE	TRUE	FALSE	3.31	8.87	6.03	55%	37%	68%		1.47	5.475161	5.80									11,772	8,033					11,772	8,033	
8/28/2018	FALSE	FALSE	FALSE	3.23	8.70	5.95	54%	37%	68%		1.46	5.499677	5.85									11,772	8,033					11,772	8,033	
8/29/2018	FALSE	FALSE	FALSE	3.23	8.98	5.93	54%	36%	66%		1.51	5.524194	5.88	250.40	173.00	0.69		12,384	8,556			11,849	8,098		12,384	8,556		11,849	8,098	
8/30/2018	FALSE	FALSE	FALSE	3.25	8.94	5.95	55%	36%	67%		1.50	5.540323	5.90									11,849	8,098					11,849	8,098	
8/31/2018	FALSE	FALSE	FALSE	3.26	8.68	5.85	56%	38%	67%		1.48	5.553871	5.90									11,849	8,098					11,849	8,098	
9/1/2018	FALSE	FALSE	FALSE	3.27	8.22	5.62	58%	40%	68%		1.46	5.560968	5.88									11,849	8,098					11,849	8,098	
9/2/2018	FALSE	FALSE	FALSE	3.22	8.20	5.51	58%	39%	67%		1.49	5.566774	5.85									11,849	8,098					11,849	8,098	
9/3/2018	FALSE	FALSE	FALSE	3.25	8.67	5.81	56%	37%	67%		1.49	5.582258	5.83									11,893	8,461					11,893	8,461	
9/4/2018	FALSE	FALSE	FALSE	3.24	8.75	5.88	55%	37%	67%		1.49	5.605806	5.81									11,893	8,461					11,893	8,461	
9/5/2018	FALSE	FALSE	FALSE	3.33	8.81	5.88	57%	38%	67%		1.50	5.62871	5.80	244.80	140.00	0.57		12,005	6,865			11,907	8,262		12,005	6,865		11,907	8,262	
9/6/2018	FALSE	FALSE	FALSE	3.37	8.63	5.97	56%	39%	69%		1.45	5.64871	5.81	231.40	173.00	0.75		11,521	8,614			11,865	8,301		11,521	8,614		11,865	8,301	
9/7/2018	FALSE	FALSE	FALSE	3.27	8.66	5.84	56%	38%	67%		1.48	5.665484	5.80									11,865	8,301					11,865	8,301	
9/8/2018	FALSE	FALSE	FALSE	3.33	8.33	5.80	57%	40%	70%		1.44	5.675161	5.79									12,025	8,341					12,025	8,341	
9/9/2018	FALSE	FALSE	FALSE	3.23	8.34	5.75	56%	39%	69%		1.45	5.685806	5.81									12,172	8,751					12,172	8,751	
9/10/2018	FALSE	FALSE	FALSE	3.18	8.17	5.88	54%	39%	72%		1.39	5.706774	5.85									12,172	8,751					12,172	8,751	
9/11/2018	FALSE	FALSE	FALSE	3.35	8.59	6.01	56%	39%	70%		1.43	5.733548	5.88									12,172	8,751					12,172	8,751	
9/12/2018	FALSE	FALSE	FALSE	3.26	8.81	6.06	54%	37%	69%		1.45	5.76	5.90									12,172	8,751					12,172	8,751	
9/13/2018	FALSE	FALSE	FALSE	3.14	8.67	5.93	53%	36%	68%		1.46	5.779355	5.91	245.80	178.00	0.72		12,156	8,803			12,170	8,758		12,156	8,803		12,170	8,758	
9/14/2018	FALSE	FALSE	FALSE	3.33	8.35	5.96	56%	40%	71%		1.40	5.795484	5.90	220.20	202.00	0.92		10,945	10,041			12,034	8,900		10,945	10,041		12,034	8,900	
9/15/2018	FALSE	FALSE	FALSE	3.23	8.10	5.86	55%	40%	72%		1.38	5.803548	5.91									12,065	8,621					12,065	8,621	
9/16/2018	FALSE	FALSE	FALSE	3.22	8.25	5.85	55%	39%	71%		1.41	5.810645	5.91									11,894	8,598					11,894	8,598	
9/17/2018	FALSE	FALSE	FALSE	3.14	8.64	5.89	53%	36%	68%		1.47	5.826452	5.93									11,894	8,598					11,894	8,598	
9/18/2018	FALSE	FALSE	FALSE	3.37	8.43	5.96	57%	40%	71%		1.41	5.843548	5.94									11,894	8,598					11,894	8,598	
9/19/2018	FALSE	FALSE	FALSE	3.32	8.65	5.92	56%	38%	68%		1.46	5.854194	5.93	265.40	217.00	0.82		13,104	10,714			12,045	8,862		13,104	10,714		12,045	8,862	
9/20/2018	FALSE	FALSE	FALSE	3.17	8.37	5.79	55%	38%	69%		1.45	5.860645	5.90									12,045	8,862					12,045	8,862	
9/21/2018	FALSE	FALSE	FALSE	3.23	8.22	5.85	55%	39%	71%		1.41	5.866452	5.89	259.90	212.00	0.82		12,680	10,343			12,116	9,027		12,680	10,343		12,116	9,027	
9/22/2018	FALSE	FALSE	FALSE	3.29	7.98	5.71	58%	41%	72%		1.40	5.864194	5.85									12,112	9,173					12,112	9,173	
9/23/2018	FALSE	FALSE	FALSE	3.19	7.89	5.73	56%	40%	73%		1.38	5.859677	5.84									12,114	9,134					12,114	9,134	
9/24/2018	FALSE	FALSE	FALSE	3.09	8.28	5.78	53%	37%	70%		1.43	5.859032	5.83									12,114	9,134					12,114	9,134	
9/25/2018	FALSE	FALSE	FALSE	3.21	8.65	5.81	55%	37%	67%		1.49	5.861613	5.82									12,114	9,134					12,114	9,134	
9/26/2018	FALSE	FALSE	FALSE	3.22	8.57	5.77	56%	38%	67%		1.49	5.855806	5.80	260.40	150.00	0.58		12,531	7,218			12,166	8,894		12,531	7,218		12,166	8,894	
9/27/2018	FALSE	FALSE	FALSE	3.25	8.39	5.77	56%	39%	69%		1.45	5.847419	5.78	252.60	187.00	0.74		12,156	8,999			12,165	8,906		12,156	8,999		12,165	8,906	
9/28/2018	FALSE	FALSE	FALSE	3.31	8.03	5.86	56%	41%	73%		1.37	5.844516	5.79									12,165	8,906					12,165	8,906	
9/29/2018	FALSE	FALSE	FALSE	3.25	8.19	5.89	55%	40%	72%		1.39	5.843226	5.79									12,137	8,950					12,137	8,950	
9/30/2018	FALSE	FALSE	FALSE	3.12	8.15	5.82	54%	38%	71%		1.40	5.839032	5.80									12,137	8,950					12,137	8,950	
10/1/2018	FALSE	FALSE	FALSE	3.12	8.40	5.96	52%	37%	71%		1.41	5.842581	5.83									12,137	8,950					12,137	8,950	
10/2/2018	FALSE	FALSE	TRUE	3.15	8.36	6.05	52%	38%	72%		1.38	5.856452	5.87									12,137	8,950					12,137	8,950	
10/3/2018	FALSE	FALSE	TRUE	3.25	8.64	6.13	53%	38%	71%		1.41	5.876452	5.91									12,137	8,950					12,137	8,950	
10/4/2018	FALSE	FALSE	TRUE	3.29	8.61	6.14	54%	38%	71%		1.40	5.887097	5.95	295.10	186.00	0.63		15,111	9,525			12,468	9,014		15,111	9,525		12,468	9,014	
10/5/2018	FALSE	FALSE	TRUE	3.27	8.35	5.98	55%	39%	72%		1.40	5.890323	5.98	297.80	233.00	0.78		14,852	11,620			12,706	9,274		14,852	11,620		12,706	9,274	
10/6/2018	FALSE	FALSE	FALSE	3.23	8.31	5.80	56%	39%	70%		1.43	5.887742	5.97									12,784	9,542					12,784	9,542	
10/7/2018	FALSE	FALSE	FALSE	3.15	8.17	5.73	55%	39%	70%		1.43	5.88	5.95									12,942	9,658					12,942	9,658	
10/8/2018	FALSE	FALSE	FALSE	3.09	8.05	5.81	53%	38%	72%		1.39	5.879032	5.95									12,942	9,658					12,942	9,658	
10/9/2018	FALSE	FALSE	FALSE	3.24	8.30	5.82	56%	39%	70%		1.43	5.879677	5.93									12,942	9,658					12,942	9,658	
10/10/2018	FALSE	FALSE	FALSE	3.18	8.63	5.81	55%	37%	67%		1.49	5.881613	5.90	371.00	165.00	0.44		17,977	7,995			13,501	9,473		17,977	7,995		13,501	9,473	
10/11/2018	FALSE	FALSE	FALSE	3.20	8.25	5.87	55%	39%	71%		1.41	5.88129	5.87	133.10	311.00	2.34		6,516	15,225			12,803	10,048		6,239	15,124		12,775	10,038	
10/12/2018	FALSE	FALSE	FALSE	3.20	8.21	5.85	55%	39%	71%		1.40	5.876129	5.83									12,803	10,048					12,775	10,038	
10/13/2018	FALSE	FALSE	FALSE	3.21	7.88	5.64	57%	41%	72%		1.40	5.862581	5.79									12,803	10,048					12,775	10,038	
10/14/2018	FALSE	FALSE	FALSE	3.17	8.00	5.68	56%	40%	71%		1.41	5.854516	5.78									12,875	10,187					12,844	10,175	
10/15/2018	FALSE	FALSE	FALSE	3.15	8.26	5.78	54%	38%	70%		1.43	5.84871	5.78									13								

Date	Butte Break?	CSU Break?	Precip?	Min Influent Flow, mgd	Max Influent Flow, mgd	Avg Influent Flow, mgd	Min % of Avg	Min % of Max	Avg % of Max	Flow Outlier Type	Diurnal Peak Factor (DPF)	30-d Avg of Avg Flow, mgd	7-d Avg of Avg Flow, mgd	Influent TSS Conc., mg/L	Influent BOD Conc., mg/L	BOD/TSS Ratio	Influent NH3-N Conc., mg/L	Avg Inf TSS Load, ppd	Avg Inf BOD Load, ppd	Avg Inf NH3 Load, ppd	Load Outlier Type	30-d Avg of TSS Load, ppd	30-d Avg of BOD Load, ppd	30-d Avg of NH3-N Load, ppd	non-SN TSS Load, ppd	non-SN BOD Load, ppd	non-SN NH3 Load, ppd	30-d Avg of non-SN TSS Load, ppd	30-d Avg of non-SN BOD Load, ppd	30-d Avg of non-SN NH3-N Load, ppd
10/25/2018	FALSE	FALSE	FALSE	3.18	8.51	5.88	54%	37%	69%		1.45	5.847742	5.83	294.20	151.00	0.51		14,427	7,405			13,421	9,984		14,427	7,405		13,394	9,974	
10/26/2018	FALSE	FALSE	FALSE	3.18	8.33	5.86	54%	38%	70%		1.42	5.849355	5.82									13,421	9,984					13,394	9,974	
10/27/2018	FALSE	FALSE	FALSE	3.22	8.13	5.74	56%	40%	71%		1.42	5.848387	5.82									13,520	10,292					13,489	10,280	
10/28/2018	FALSE	FALSE	FALSE	3.20	8.51	5.79	55%	38%	68%		1.47	5.849032	5.83									13,691	10,453					13,656	10,440	
10/29/2018	FALSE	FALSE	FALSE	3.15	8.14	5.85	54%	39%	72%		1.39	5.84871	5.84									13,691	10,453					13,656	10,440	
10/30/2018	FALSE	FALSE	FALSE	3.16	8.23	5.90	54%	38%	72%		1.39	5.849032	5.85									13,691	10,453					13,656	10,440	
10/31/2018	FALSE	FALSE	FALSE	3.15	8.40	5.83	54%	38%	69%		1.44	5.849355	5.84									13,691	10,453					13,656	10,440	
11/1/2018	FALSE	FALSE	FALSE	3.25	7.98	5.84	56%	41%	73%		1.37	5.845484	5.84									13,691	10,453					13,656	10,440	
11/2/2018	FALSE	FALSE	FALSE	3.18	8.27	5.85	54%	38%	71%		1.41	5.839032	5.83									13,691	10,453					13,656	10,440	
11/3/2018	FALSE	FALSE	FALSE	3.18	8.11	5.76	55%	39%	71%		1.41	5.827097	5.82									13,691	10,453					13,656	10,440	
11/4/2018	FALSE	FALSE	FALSE	3.09	8.66	5.90	52%	36%	68%		1.47	5.819355	5.84									13,488	10,586					13,448	10,571	
11/5/2018	FALSE	FALSE	FALSE	3.11	8.19	5.82	53%	38%	71%		1.41	5.814194	5.84									13,261	10,413					13,214	10,396	
11/6/2018	FALSE	FALSE	FALSE	3.17	8.11	5.90	54%	39%	73%		1.37	5.817419	5.85									13,261	10,413					13,214	10,396	
11/7/2018	FALSE	FALSE	FALSE	3.15	8.09	5.84	54%	39%	72%		1.39	5.820968	5.84									13,261	10,413					13,214	10,396	
11/8/2018	FALSE	FALSE	FALSE	3.12	7.95	5.81	54%	39%	73%		1.37	5.820968	5.84	255.60	197.00	0.77		12,385	9,546			13,136	10,289	12,385	9,546			13,096	10,275	
11/9/2018	FALSE	FALSE	FALSE	3.14	6.99	5.15	61%	45%	74%		1.36	5.799355	5.75									13,136	10,289					13,096	10,275	
11/10/2018	FALSE	FALSE	FALSE	3.07	7.22	5.16	59%	43%	71%		1.40	5.778387	5.67									12,329	10,672					12,282	10,655	
11/11/2018	FALSE	FALSE	FALSE	3.04	7.54	5.36	57%	40%	71%		1.41	5.761935	5.62									13,491	9,761					13,491	9,761	
11/12/2018	FALSE	FALSE	FALSE	3.08	7.96	5.66	54%	39%	71%		1.41	5.755806	5.59									13,491	9,761					13,491	9,761	
11/13/2018	FALSE	FALSE	FALSE	3.18	7.63	5.79	55%	42%	76%		1.32	5.760645	5.58									13,491	9,761					13,491	9,761	
11/14/2018	FALSE	FALSE	FALSE	3.11	7.88	5.84	53%	39%	74%		1.35	5.765806	5.58	249.30	170.00	0.68		12,142	8,280			13,266	9,514	12,142	8,280			13,266	9,514	
11/15/2018	FALSE	FALSE	FALSE	3.19	7.74	5.85	55%	41%	76%		1.32	5.768065	5.58	253.00	259.00	1.02		12,344	12,636			13,135	9,960	12,344	12,636			13,135	9,960	
11/16/2018	FALSE	TRUE	FALSE	3.29	8.05	5.86	56%	41%	73%		1.37	5.769677	5.58									13,135	9,960					13,135	9,960	
11/17/2018	FALSE	TRUE	FALSE	3.19	7.97	5.71	56%	40%	72%		1.40	5.764516	5.65									13,097	10,135					13,097	10,135	
11/18/2018	FALSE	TRUE	FALSE	3.23		5.72	56%			inMaxAvgM	0.00	5.76	5.72									12,905	10,027					12,905	10,027	
11/19/2018	FALSE	TRUE	FALSE	3.03	7.59	5.81	52%	40%	77%		1.31	5.76	5.79									12,905	10,027					12,905	10,027	
11/20/2018	FALSE	TRUE	FALSE	3.22	7.85	5.87	55%	41%	75%		1.34	5.765333	5.82									12,905	10,027					12,905	10,027	
11/21/2018	TRUE	TRUE	TRUE	3.16	8.50	6.18	51%	37%	73%		1.38	5.779667	5.87	274.50	210.00	0.77		14,148	10,824			13,112	10,160	14,148	10,824			13,112	10,160	
11/22/2018	TRUE	TRUE	TRUE	3.39	9.43	6.02	56%	36%	64%		1.57	5.786	5.90									13,112	10,160					13,112	10,160	
11/23/2018	TRUE	TRUE	TRUE	3.28	8.48	5.88	56%	39%	69%		1.44	5.785667	5.90									13,112	10,160					13,112	10,160	
11/24/2018	TRUE	TRUE	FALSE	3.40	8.78	6.10	56%	39%	69%		1.44	5.793667	5.94									13,089	9,738					13,089	9,738	
11/25/2018	TRUE	TRUE	FALSE	3.31	8.88	6.35	52%	37%	72%		1.40	5.809333	6.03									12,755	10,321					12,755	10,321	
11/26/2018	TRUE	TRUE	FALSE	3.24	8.50	6.46	50%	38%	76%		1.32	5.829333	6.08									12,755	10,321					12,755	10,321	
11/27/2018	FALSE	FALSE	TRUE	3.31	8.79	6.61	50%	38%	75%		1.33	5.858333	6.18									12,755	10,321					12,755	10,321	
11/28/2018	FALSE	FALSE	TRUE	3.49	9.03	6.70	52%	39%	74%		1.35	5.888667	6.29	248.60				13,891				12,982	10,321	13,891				12,982	10,321	
11/29/2018	FALSE	FALSE	TRUE	3.85	11.12	8.34	46%	35%	75%		1.33	5.971667	6.56	244.80	173.00	0.71		17,027	12,033			13,656	10,664	16,972	12,008			13,647	10,659	
11/30/2018	FALSE	FALSE	TRUE	4.47	11.13	7.97	56%	40%	72%		1.40	6.040667	6.80									13,656	10,664					13,647	10,659	
12/1/2018	FALSE	FALSE	FALSE	3.69	10.08	7.20	51%	37%	71%		1.40	6.086333	6.97									13,656	10,664					13,647	10,659	
12/2/2018	FALSE	FALSE	FALSE	3.47	9.87	6.99	50%	35%	71%		1.41	6.124667	7.08									13,656	10,664					13,647	10,659	
12/3/2018	FALSE	FALSE	FALSE	3.41	9.32	6.79	50%	37%	73%		1.37	6.156	7.13									13,656	10,664					13,647	10,659	
12/4/2018	FALSE	FALSE	FALSE	3.33	9.32	6.70	50%	36%	72%		1.39	6.187333	7.16									13,656	10,664					13,647	10,659	
12/5/2018	FALSE	FALSE	TRUE	3.33	9.15	6.70	50%	36%	73%		1.37	6.214	7.17	218.40	234.00	1.07		12,204	13,075			13,449	11,066	12,204	13,075			13,441	11,062	
12/6/2018	FALSE	FALSE	FALSE	3.33	9.14	6.63	50%	36%	73%		1.38	6.241	7.17	221.70	244.00	1.10		12,259	13,492			13,300	11,412	12,259	13,492			13,293	11,409	
12/7/2018	FALSE	FALSE	FALSE	3.36	8.93	6.53	51%	38%	73%		1.37	6.262	6.94									13,300	11,412					13,293	11,409	
12/8/2018	FALSE	FALSE	FALSE	3.29	9.27	6.42	51%	35%	69%		1.44	6.281333	6.75									13,300	11,412					13,293	11,409	
12/9/2018	FALSE	FALSE	FALSE	3.21	9.17	6.44	50%	35%	70%		1.42	6.302333	6.65									13,431	11,723					13,423	11,719	
12/10/2018	FALSE	FALSE	TRUE	3.20	8.53	6.38	50%	38%	75%		1.34	6.343333	6.57									13,431	11,723					13,423	11,719	
12/11/2018	FALSE	FALSE	FALSE	3.16	8.80	6.45	49%	36%	73%		1.36	6.386333	6.53									13,431	11,723					13,423	11,719	
12/12/2018	FALSE	FALSE	FALSE	3.16	8.96	6.40	49%	35%	71%		1.40	6.421	6.49	233.30	235.00	1.01		12,453	12,543			13,308	11,841	12,453	12,543			13,302	11,837	
12/13/2018	FALSE	FALSE	FALSE	3.27	8.56	6.34	52%	38%	74%		1.35	6.443667	6.45	247.00	198.00	0.80		13,060	10,469			13,281	11,669	12,872	10,415			13,254	11,659	
12/14/2018	FALSE	FALSE	TRUE	3.22	8.62	6.37	51%	37%	74%		1.35	6.463	6.42									13,281	11,669					13,254	11,659	
12/15/2018	FALSE	FALSE	TRUE	3.37	9.63	6.58	51%	35%	68%		1.46	6.487667	6.42									13,423	12,153					13,393	12,142	
12/16/2018	FALSE	TRUE	TRUE	3.27	12.22	7.44	44%	27%	61%		1.64	6.540667	6.55									13,577	12,073					13,543	12,060	
12/17/2018	FALSE	TRUE	TRUE	7.34	12.31	10.16	72%	60%	83%	inAvgMinM	1.21	6.564138	6.57									13,577	12,073					13,543		

Date	Butte Break?	CSU Break?	Precip?	Min Influent Flow, mgd	Max Influent Flow, mgd	Avg Influent Flow, mgd	Min % of Avg	Min % of Max	Avg % of Max	Flow Outlier Type	Diurnal Peak Factor (DPF)	30-d Avg of Avg Flow, mgd	7-d Avg of Avg Flow, mgd	Influent TSS Conc., mg/L	Influent BOD Conc., mg/L	BOD/TSS Ratio	Influent NH3-N Conc., mg/L	Avg Inf TSS Load, ppd	Avg Inf BOD Load, ppd	Avg Inf NH3 Load, ppd	Load Outlier Type	30-d Avg of TSS Load, ppd	30-d Avg of BOD Load, ppd	30-d Avg of NH3-N Load, ppd	non-SN TSS Load, ppd	non-SN BOD Load, ppd	non-SN NH3 Load, ppd	30-d Avg of non-SN TSS Load, ppd	30-d Avg of non-SN BOD Load, ppd	30-d Avg of non-SN NH3-N Load, ppd
12/27/2018	TRUE	TRUE	FALSE	3.53	8.49	6.52	54%	42%	77%		1.30	6.838333	6.72	218.00	176.00	0.81		11,854	9,570			12,666	12,361		11,854	9,570		12,635	12,350	
12/28/2018	TRUE	TRUE	FALSE	3.27	8.27	6.24	52%	40%	75%		1.33	6.826	6.60									12,666	12,361					12,635	12,350	
12/29/2018	TRUE	TRUE	FALSE	3.35	8.61	6.05	55%	39%	70%		1.42	6.804333	6.45									12,491	12,361					12,456	12,350	
12/30/2018	TRUE	TRUE	FALSE	3.25	8.10	5.91	55%	40%	73%		1.37	6.723333	6.35									11,735	12,416					11,703	12,407	
12/31/2018	TRUE	TRUE	FALSE	3.18	8.19	6.02	53%	39%	74%		1.36	6.658333	6.31									11,735	12,416					11,703	12,407	
1/1/2019	TRUE	TRUE	FALSE	3.26	7.80	5.64	58%	42%	72%		1.38	6.61	6.17									11,735	12,416					11,703	12,407	
1/2/2019	TRUE	TRUE	FALSE	3.13	7.68	5.88	53%	41%	77%		1.31	6.57	6.10									11,735	12,416					11,703	12,407	
1/3/2019	TRUE	TRUE	FALSE	3.23	7.79	5.92	55%	41%	76%		1.32	6.54	6.02	259.70	191.00	0.74		12,822	9,430			11,890	11,990		12,822	9,430		11,863	11,982	
1/4/2019	TRUE	TRUE	FALSE	3.24	7.81	5.93	55%	41%	76%		1.32	6.51	5.95									11,890	11,990					11,863	11,982	
1/5/2019	TRUE	TRUE	TRUE	3.13	8.89	6.04	52%	35%	68%		1.47	6.49	5.92									11,838	11,809					11,806	11,800	
1/6/2019	TRUE	TRUE	TRUE	3.29	13.05	7.59	43%	25%	58%		1.72	6.52	6.12									11,754	11,472					11,716	11,461	
1/7/2019	TRUE	TRUE	TRUE	5.79	12.39	9.08	64%	47%	73%		1.36	6.61	6.51									11,754	11,472					11,716	11,461	
1/8/2019	TRUE	TRUE	TRUE	4.22	12.68	8.18	52%	33%	65%		1.55	6.67	6.78									11,754	11,472					11,716	11,461	
1/9/2019	TRUE	TRUE	TRUE	8.16	12.98	11.01	74%	63%	85%	inAvgMinM	1.18	6.68	6.95	147.20	223.00	1.51		13,516	20,477			12,047	12,973		13,516	20,477		12,016	12,964	
1/10/2019	TRUE	TRUE	TRUE	5.43	11.43	8.87	61%	48%	78%		1.29	6.76	7.37	157.80	189.00	1.20		11,673	13,981			11,994	13,117		11,673	13,981		11,967	13,109	
1/11/2019	TRUE	TRUE	FALSE	4.72	11.01	8.09	58%	43%	73%		1.36	6.82	7.68									11,994	13,117					11,967	13,109	
1/12/2019	TRUE	TRUE	FALSE	4.22	9.72	7.37	57%	43%	76%		1.32	6.85	7.89									11,918	13,212					11,886	13,203	
1/13/2019	TRUE	TRUE	FALSE	3.86	9.58	7.11	54%	40%	74%		1.35	6.88	8.04									11,689	13,761					11,689	13,761	
1/14/2019	TRUE	TRUE	TRUE	3.53	9.14	6.87	51%	39%	75%		1.33	6.90	7.94									11,689	13,761					11,689	13,761	
1/15/2019	TRUE	TRUE	TRUE	3.64	10.75	7.07	51%	34%	66%		1.52	6.91	7.65									11,689	13,761					11,689	13,761	
1/16/2019	TRUE	TRUE	TRUE	5.53	17.15	11.13	50%	32%	65%		1.54	7.04	8.07	213.50				19,818				13,044	13,761		19,818			13,044	13,761	
1/17/2019	TRUE	TRUE	TRUE	8.35	17.17	12.13	69%	49%	71%		1.42	7.21	8.58	161.20	219.00	1.36		16,308	22,155			13,510	15,160		16,308	22,155		13,510	15,160	
1/18/2019	TRUE	TRUE	TRUE	6.16	12.59	9.83	63%	49%	78%		1.28	7.27	8.70									13,510	15,160					13,510	15,160	
1/19/2019	TRUE	TRUE	TRUE	5.34	12.23	8.76	61%	44%	72%		1.40	7.31	8.78									14,332	15,123					14,332	15,123	
1/20/2019	TRUE	TRUE	TRUE	4.58	11.39	8.26	55%	40%	73%		1.38	7.35	8.90									14,332	15,123					14,332	15,123	
1/21/2019	TRUE	TRUE	TRUE	4.63	11.09	8.50	54%	42%	77%		1.30	7.39	9.07									14,332	15,123					14,332	15,123	
1/22/2019	TRUE	TRUE	FALSE	3.98	11.02	7.98	50%	36%	72%		1.38	7.44	9.21									14,332	15,123					14,332	15,123	
1/23/2019	TRUE	FALSE	FALSE	3.98	10.55	7.67	52%	38%	73%		1.38	7.48	9.28	145.20	263.00	1.81		9,288	16,824			13,611	15,406		9,288	16,824		13,611	15,406	
1/24/2019	FALSE	FALSE	FALSE	3.81	10.54	7.47	51%	36%	71%		1.41	7.50	8.83	191.50	236.00	1.23		11,930	14,703			13,401	15,306		11,565	14,604		13,356	15,292	
1/25/2019	FALSE	FALSE	FALSE	3.71	9.86	7.13	52%	38%	72%		1.38	7.53	8.20									13,401	15,306					13,356	15,292	
1/26/2019	FALSE	FALSE	FALSE	3.59	10.22	7.01	51%	35%	69%		1.46	7.54	7.85									13,401	15,306					13,356	15,292	
1/27/2019	FALSE	FALSE	FALSE	3.47	9.74	6.94	50%	36%	71%		1.40	7.56	7.62									13,622	16,262					13,570	16,245	
1/28/2019	FALSE	FALSE	FALSE	3.39	9.42	6.92	49%	36%	73%		1.36	7.58	7.45									13,622	16,262					13,570	16,245	
1/29/2019	FALSE	FALSE	FALSE	3.39	9.38	6.80	50%	36%	72%		1.38	7.60	7.24									13,622	16,262					13,570	16,245	
1/30/2019	FALSE	FALSE	FALSE	3.37	9.58	6.74	50%	35%	70%		1.42	7.63	7.09	238.80	253.00	1.06		13,423	14,222			13,597	15,970		13,423	14,222		13,552	15,956	
1/31/2019	FALSE	FALSE	FALSE	3.47	9.28	6.67	52%	37%	72%		1.39	7.65	6.96	214.80	229.00	1.07		11,949	12,739			13,414	15,566		11,949	12,739		13,374	15,554	
2/1/2019	FALSE	FALSE	TRUE	3.33	9.26	6.70	50%	36%	72%		1.38	7.69	6.86									13,414	15,566					13,374	15,554	
2/2/2019	FALSE	FALSE	TRUE	4.87	15.57	10.54	46%	31%	68%		1.48	7.84	7.29									13,414	15,566					13,374	15,554	
2/3/2019	FALSE	FALSE	TRUE	8.26	15.20	11.73	70%	54%	77%	MinAvg	1.30	7.91	7.33									13,488	16,443					13,443	16,429	
2/4/2019	FALSE	FALSE	TRUE	7.49	15.15	11.93	63%	49%	79%		1.27	8.12	8.04									13,488	16,443					13,443	16,429	
2/5/2019	FALSE	FALSE	TRUE	6.25	13.25	10.19	61%	47%	77%		1.30	8.26	8.51									13,488	16,443					13,443	16,429	
2/6/2019	FALSE	FALSE	FALSE	5.45	12.15	9.30	59%	45%	77%		1.31	8.32	8.87									13,488	16,443					13,443	16,429	
2/7/2019	FALSE	FALSE	FALSE	4.52	11.50	8.49	53%	39%	74%		1.35	8.30	9.12	200.40				14,190				13,566	16,443		14,190			13,526	16,429	
2/8/2019	FALSE	FALSE	TRUE	4.20	11.16	8.03	52%	38%	72%		1.39	8.29	9.31	162.90	188.00	1.15		10,909	12,590			13,301	15,961		10,909	12,590		13,264	15,949	
2/9/2019	FALSE	FALSE	TRUE	4.09	10.85	7.77	53%	38%	72%		1.40	8.28	9.46									13,277	15,316					13,236	15,302	
2/10/2019	FALSE	FALSE	FALSE	3.83	10.17	7.52	51%	38%	74%		1.35	8.23	9.03									13,477	15,539					13,431	15,522	
2/11/2019	FALSE	FALSE	FALSE	3.54	10.18	7.30	48%	35%	72%		1.39	8.20	8.82									13,477	15,539					13,431	15,522	
2/12/2019	FALSE	FALSE	TRUE	3.42	9.95	7.08	48%	34%	71%		1.41	8.19	8.21									13,477	15,539					13,431	15,522	
2/13/2019	FALSE	FALSE	TRUE	5.74	20.93	13.34	43%	27%	64%		1.57	8.40	8.60	201.70				22,440				14,473	15,539		22,440			14,432	15,522	
2/14/2019	FALSE	FALSE	TRUE	16.13	22.01	18.59	87%	73%	84%	inAvgMinM	1.18	8.46	8.50	134.80	163.00	1.21		20,899	25,272			15,116	16,929		20,899	25,272		15,079	16,915	
2/15/2019	FALSE	FALSE	FALSE	10.10	17.23	13.94	72%	59%	81%	inAvgMinM	1.24	8.50	8.51									15,116	16,929					15,079	16,915	
2/16/2019	FALSE	FALSE	FALSE	5.58	15.55	11.29	49%	36%	73%		1.38	8.51	9.05									14,593	16,929					14,552	16,915	
2/17/2019	FALSE	FALSE	TRUE	5.73	12.37	9.46	61%	46%	76%		1.31	8.42	9.33									14,379	16,058					14,333	16,042	
2/18/2019	FALSE	FALSE	FALSE	4.93	11.52	8.97	55%	43%	78%		1.28	8.38	9.57									14,379	16,058					14,333	16,042	
2/19/2019	FALSE	FALSE	FALSE	4.25																										

Date	Butte Break?	CSU Break?	Precip?	Min Influent Flow, mgd	Max Influent Flow, mgd	Avg Influent Flow, mgd	Min % of Avg	Min % of Max	Avg % of Max	Flow Outlier Type	Diurnal Peak Factor (DPF)	30-d Avg of Avg Flow, mgd	7-d Avg of Avg Flow, mgd	Influent TSS Conc., mg/L	Influent BOD Conc., mg/L	BOD/TSS Ratio	Influent NH3-N Conc., mg/L	Avg Inf TSS Load, ppd	Avg Inf BOD Load, ppd	Avg Inf NH3 Load, ppd	Load Outlier Type	30-d Avg of TSS Load, ppd	30-d Avg of BOD Load, ppd	30-d Avg of NH3-N Load, ppd	non-SN TSS Load, ppd	non-SN BOD Load, ppd	non-SN NH3 Load, ppd	30-d Avg of non-SN TSS Load, ppd	30-d Avg of non-SN BOD Load, ppd	30-d Avg of non-SN NH3-N Load, ppd
2/28/2019	FALSE	FALSE	FALSE	11.02	19.27	14.90	74%	57%	77%	inAvgMinM	1.29	8.77	9.07	93.50	149.00	1.59		11,619	18,516			14,087	16,462		11,619	18,516		14,087	16,462	
3/1/2019	FALSE	FALSE	TRUE	9.50	16.51	13.22	72%	58%	80%	inAvgMinM	1.25	8.85	9.41	135.80	268.00	1.97		14,973	29,548			14,175	18,098		14,973	29,548		14,175	18,098	
3/2/2019	FALSE	FALSE	TRUE	8.71	17.34	13.37	65%	50%	77%		1.30	9.13	10.93									14,259	18,652					14,259	18,652	
3/3/2019	FALSE	FALSE	TRUE	8.99	16.95	13.59	66%	53%	80%		1.25	9.41	12.55									14,548	19,637					14,548	19,637	
3/4/2019	FALSE	FALSE	FALSE	9.68	16.98	13.52	72%	57%	80%	inAvgMinM	1.26	9.53	14.35									14,548	19,637					14,548	19,637	
3/5/2019	FALSE	FALSE	TRUE	8.35	16.16	12.67	66%	52%	78%		1.28	9.62	13.93									14,548	19,637					14,548	19,637	
3/6/2019	FALSE	FALSE	TRUE	10.43	17.59	14.84	70%	59%	84%	inAvgMinM	1.19	9.62	13.21									14,548	19,637					14,548	19,637	
3/7/2019	FALSE	FALSE	FALSE	10.06	17.42	14.18	71%	58%	81%	inAvgMinM	1.23	9.52	13.21	142.60	187.00	1.31		16,864	22,115			14,805	19,991		16,864	22,115		14,805	19,991	
3/8/2019	FALSE	FALSE	FALSE	9.24	16.81	12.68	73%	55%	75%	inAvgMinM	1.33	9.49	13.21	138.60	204.00	1.47		14,657	21,573			14,790	20,189		14,657	21,573		14,790	20,189	
3/9/2019	FALSE	FALSE	TRUE	8.41	15.14	12.01	70%	56%	79%	inAvgMinM	1.26	9.50	13.21									14,790	20,189					14,790	20,189	
3/10/2019	FALSE	FALSE	TRUE	7.95	14.58	11.41	70%	55%	78%	MinAvg	1.28	9.55	13.13									14,857	20,189					14,857	20,189	
3/11/2019	FALSE	FALSE	FALSE	7.34	14.29	11.08	66%	51%	78%		1.29	9.71	11.88									15,351	21,274					15,351	21,274	
3/12/2019	FALSE	FALSE	FALSE	7.63	15.03	10.69	71%	51%	71%	MinAvg	1.41	9.82	11.88									15,351	21,274					15,351	21,274	
3/13/2019	TRUE	FALSE	FALSE	7.23	13.56	10.38	70%	53%	77%	MinAvg	1.31	9.95	11.08	194.20	230.00	1.18		16,812	19,911			15,513	21,104		16,812	19,911		15,513	21,104	
3/14/2019	TRUE	FALSE	FALSE	7.01	13.36	9.94	71%	52%	74%	MinAvg	1.34	10.12	11.08	195.70				16,223				15,584	21,104		15,888			15,550	21,104	
3/15/2019	TRUE	FALSE	FALSE	6.82	12.50	9.46	72%	55%	76%	MinAvg	1.32	10.32	11.08									15,584	21,104					15,550	21,104	
3/16/2019	TRUE	TRUE	FALSE	6.77	11.12	8.98	75%	61%	81%	inAvgMinM	1.24	10.11	11.08									14,822	21,104					14,785	21,104	
3/17/2019	TRUE	TRUE	FALSE	6.70	10.92	8.81	76%	61%	81%	inAvgMinM	1.24	10.11	11.08									14,062	20,508					14,021	20,508	
3/18/2019	TRUE	TRUE	FALSE	6.70	10.53	8.65	77%	64%	82%	inAvgMinM	1.22	10.11	11.08									14,062	20,508					14,021	20,508	
3/19/2019	TRUE	TRUE	FALSE	6.65	10.70	8.74	76%	62%	82%	inAvgMinM	1.22	10.02	#DIV/0!									14,062	20,508					14,021	20,508	
3/20/2019	FALSE	TRUE	TRUE	6.73	10.57	9.02	75%	64%	85%	inAvgMinM	1.17	10.06	#DIV/0!									14,062	20,508					14,021	20,508	
3/21/2019	FALSE	TRUE	FALSE	6.86	11.01	8.86	77%	62%	80%	inAvgMinM	1.24	10.16	#DIV/0!	233.90	299.00	1.28		17,283	22,094			14,420	20,707		17,283	22,094		14,383	20,707	
3/22/2019	FALSE	TRUE	TRUE	6.96	10.86	9.01	77%	64%	83%	inAvgMinM	1.21	10.41	#DIV/0!	245.90	197.00	0.80		18,478	14,803			14,826	20,051		18,478	14,803		14,793	20,051	
3/23/2019	FALSE	TRUE	TRUE	6.73	12.43	9.38	72%	54%	75%	MinAvg	1.33	10.67	#DIV/0!									15,187	20,676					15,150	20,676	
3/24/2019	FALSE	TRUE	FALSE	6.76	11.71	9.45	72%	58%	81%	inAvgMinM	1.24	11.05	#DIV/0!									15,864	21,223					15,822	21,223	
3/25/2019	FALSE	TRUE	TRUE	6.59	13.11	10.21	65%	50%	78%		1.28	11.41	10.21									15,864	21,223					15,822	21,223	
3/26/2019	FALSE	TRUE	TRUE	7.44	13.61	10.35	72%	55%	76%	MinAvg	1.31	12.02	10.21									15,864	21,223					15,822	21,223	
3/27/2019	FALSE	FALSE	TRUE	8.11	13.71	11.33	72%	59%	83%	inAvgMinM	1.21	12.84	10.21	218.30	215.00	0.98		20,628	20,316			16,393	21,109		20,628	20,316		16,356	21,109	
3/28/2019	FALSE	FALSE	TRUE	7.60	14.13	10.77	71%	54%	76%	MinAvg	1.31	12.84	10.21	127.90	235.00	1.84		11,488	21,108			15,902	21,109		11,488	21,108		15,869	21,109	
3/29/2019	FALSE	FALSE	FALSE	7.30	13.33	10.10	72%	55%	76%	inAvgMinM	1.32	12.18	10.21									15,902	21,109					15,869	21,109	
3/30/2019	FALSE	FALSE	FALSE	7.19	12.08	9.75	74%	60%	81%	inAvgMinM	1.24	12.18	10.21									15,902	21,109					15,869	21,109	
3/31/2019	FALSE	FALSE	FALSE	6.94	12.10	9.53	73%	57%	79%	inAvgMinM	1.27	12.18	10.21									16,378	21,434					16,341	21,434	
4/1/2019	FALSE	FALSE	TRUE	7.18	12.44	9.78	73%	58%	79%	inAvgMinM	1.27	12.18	10.21									16,554	20,274					16,512	20,274	
4/2/2019	FALSE	FALSE	TRUE	7.00	24.55	11.31	62%	29%	46%	AvgMax	2.17	11.89	#DIV/0!									16,554	20,274					16,512	20,274	
4/3/2019	FALSE	FALSE	FALSE	12.76	24.15	15.87	80%	53%	66%	MinAvg	1.52	11.32	#DIV/0!	313.20	105.00	0.34		41,454	13,897			19,321	19,477		41,454	13,897		19,284	19,477	
4/4/2019	FALSE	FALSE	FALSE	8.85	15.77	12.46	71%	56%	79%	inAvgMinM	1.27	11.32	#DIV/0!									19,321	19,477					19,284	19,477	
4/5/2019	FALSE	FALSE	TRUE	8.41	14.88	11.69	72%	57%	79%	inAvgMinM	1.27	10.65	#DIV/0!	134.10	226.00	1.69		13,074	22,034			18,696	19,761		13,074	22,034		18,663	19,761	
4/6/2019	FALSE	FALSE	TRUE	7.89	13.62	10.87	73%	58%	80%	inAvgMinM	1.25	10.65	#DIV/0!									18,696	19,761					18,663	19,761	
4/7/2019	FALSE	FALSE	FALSE	7.46	12.61	10.27	73%	59%	81%	inAvgMinM	1.23	10.65	#DIV/0!									18,900	19,467					18,862	19,467	
4/8/2019	FALSE	FALSE	FALSE	7.18	12.95	10.30	70%	55%	80%	inAvgMinM	1.26	10.65	#DIV/0!									19,430	19,166					19,388	19,166	
4/9/2019	FALSE	FALSE	FALSE	6.78	12.50	10.03	68%	54%	80%		1.25	10.44	10.03									19,430	19,166					19,388	19,166	
4/10/2019	FALSE	FALSE	FALSE	6.77	12.50	9.55	71%	54%	76%	MinAvg	1.31	10.44	10.03									19,430	19,166					19,388	19,166	
4/11/2019	FALSE	FALSE	FALSE	6.72	11.92	9.44	71%	56%	79%	inAvgMinM	1.26	10.12	10.03	238.10				18,746				19,354	19,166		18,746			19,317	19,166	
4/12/2019	FALSE	FALSE	FALSE	6.79	11.63	9.35	73%	58%	80%	inAvgMinM	1.24	10.12	10.03	228.00	223.00	0.98		17,779	17,389			19,196	18,944		17,779	17,389		19,163	18,944	
4/13/2019	FALSE	FALSE	FALSE	6.80	11.20	9.06	75%	61%	81%	inAvgMinM	1.24	10.12	10.03									19,461	18,806					19,424	18,806	
4/14/2019	FALSE	FALSE	FALSE	6.63	11.22	9.17	72%	59%	82%	inAvgMinM	1.22	10.12	10.03									19,866	18,806					19,866	18,806	
4/15/2019	FALSE	FALSE	TRUE	6.79	11.65	9.39	72%	58%	81%	inAvgMinM	1.24	10.12	10.03									19,866	18,806					19,866	18,806	
4/16/2019	FALSE	FALSE	TRUE	6.76	11.63	9.12	74%	58%	78%	inAvgMinM	1.28	10.12	10.03									19,866	18,806					19,866	18,806	
4/17/2019	FALSE	FALSE	FALSE	6.46	11.71	8.98	72%	55%	77%	inAvgMinM	1.30	10.12	#DIV/0!	240.50	105.00	0.44		18,012	7,864			19,660	17,438		18,012	7,864		19,660	17,438	
4/18/2019	FALSE	FALSE	FALSE	3.40	11.58	7.47	46%	29%	65%		1.55	9.24	7.47	232.40	188.00	0.81		14,478	11,712			19,142	16,802		14,478	11,712		19,142	16,802	
4/19/2019	FALSE	FALSE	FALSE	3.58	8.91	6.67	54%	40%	75%		1.34	8.60	7.07									19,142	16,802					19,142	16,802	
4/20/2019	FALSE	FALSE	TRUE	3.46	8.73	6.50	53%	40%	74%		1.34																			

Date	Butte Break?	CSU Break?	Precip?	Min Influent Flow, mgd	Max Influent Flow, mgd	Avg Influent Flow, mgd	Min % of Avg	Min % of Max	Avg % of Max	Flow Outlier Type	Diurnal Peak Factor (DPF)	30-d Avg of Avg Flow, mgd	7-d Avg of Avg Flow, mgd	Influent TSS Conc., mg/L	Influent BOD Conc., mg/L	BOD/TSS Ratio	Influent NH3-N Conc., mg/L	Avg Inf TSS Load, ppd	Avg Inf BOD Load, ppd	Avg Inf NH3 Load, ppd	Load Outlier Type	30-d Avg of TSS Load, ppd	30-d Avg of BOD Load, ppd	30-d Avg of NH3-N Load, ppd	non-SN TSS Load, ppd	non-SN BOD Load, ppd	non-SN NH3 Load, ppd	30-d Avg of non-SN TSS Load, ppd	30-d Avg of non-SN BOD Load, ppd	30-d Avg of non-SN NH3-N Load, ppd
5/2/2019	FALSE	FALSE	FALSE	3.32	9.20	6.28	53%	36%	68%		1.46	6.71	6.34	188.60	189.00	1.00		9,878	9,899			17,020	12,439		9,878	9,899		17,020	12,439	
5/3/2019	FALSE	FALSE	FALSE	3.35	8.87	6.37	53%	38%	72%		1.39	6.69	6.33									14,305	12,257					14,305	12,257	
5/4/2019	FALSE	FALSE	FALSE	3.36	8.52	6.19	54%	39%	73%		1.38	6.67	6.30									14,305	12,257					14,305	12,257	
5/5/2019	FALSE	FALSE	FALSE	3.26	8.79	6.23	52%	37%	71%		1.41	6.64	6.30									14,459	10,860					14,459	10,860	
5/6/2019	FALSE	FALSE	FALSE	3.20	8.77	6.29	51%	36%	72%		1.39	6.62	6.30									14,459	10,860					14,459	10,860	
5/7/2019	FALSE	FALSE	FALSE	3.29	8.96	6.34	52%	37%	71%		1.41	6.61	6.29									14,528	10,774		15,077	10,168		14,528	10,774	
5/8/2019	FALSE	FALSE	FALSE	3.37	9.04	6.35	53%	37%	70%		1.42	6.60	6.29	284.70	192.00	0.67		15,077	10,168			14,253	11,031		11,781	13,089		14,253	11,031	
5/9/2019	FALSE	FALSE	FALSE	3.28	9.02	6.38	51%	36%	71%		1.41	6.59	6.30	221.40	246.00	1.11		11,781	13,089			14,253	11,031		11,781	13,089		14,253	11,031	
5/10/2019	FALSE	FALSE	FALSE	3.51	8.77	6.24	56%	40%	71%		1.41	6.42	6.30									14,253	11,031					14,253	11,031	
5/11/2019	FALSE	FALSE	FALSE	3.35	8.38	6.11	55%	40%	73%		1.37	6.41	6.27									14,253	11,031					14,253	11,031	
5/12/2019	FALSE	FALSE	FALSE	3.27	8.36	6.04	54%	39%	72%		1.38	6.40	6.25									13,754	11,031					13,754	11,031	
5/13/2019	FALSE	FALSE	FALSE	3.30	8.47	6.20	53%	39%	73%		1.37	6.39	6.24									13,251	10,236					13,251	10,236	
5/14/2019	FALSE	FALSE	FALSE	3.40	8.67	6.31	54%	39%	73%		1.37	6.39	6.25									13,251	10,236					13,251	10,236	
5/15/2019	FALSE	FALSE	TRUE	3.55	11.00	6.63	54%	32%	60%		1.66	6.40	6.28									13,251	10,236					13,251	10,236	
5/16/2019	FALSE	FALSE	TRUE	5.38	11.01	8.64	62%	49%	78%		1.27	6.47	6.57	259.10	204.00	0.79		18,670	14,700			13,853	10,732		18,670	14,700		13,853	10,732	
5/17/2019	FALSE	FALSE	TRUE	3.80	10.50	7.29	52%	36%	69%		1.44	6.50	6.68									13,853	10,732					13,853	10,732	
5/18/2019	FALSE	FALSE	TRUE	3.64	9.63	7.05	52%	38%	73%		1.37	6.52	6.78									13,333	11,091					13,333	11,091	
5/19/2019	FALSE	TRUE	TRUE	4.44	10.22	7.75	57%	43%	76%		1.32	6.53	6.99									13,169	11,002					13,169	11,002	
5/20/2019	FALSE	TRUE	TRUE	4.15	10.06	7.34	57%	41%	73%		1.37	6.55	7.15									13,169	11,002					13,169	11,002	
5/21/2019	FALSE	TRUE	TRUE	3.80	9.69	7.04	54%	39%	73%		1.38	6.57	7.26									13,169	11,002					13,169	11,002	
5/22/2019	FALSE	TRUE	FALSE	3.70	9.14	6.76	55%	40%	74%		1.35	6.58	7.31	228.90	196.00	0.86		12,905	11,050			13,136	11,008		12,905	11,050		13,136	11,008	
5/23/2019	TRUE	TRUE	FALSE	3.62	9.06	6.63	55%	40%	73%		1.37	6.58	7.31	231.50	127.00	0.55		12,801	7,022			13,099	10,565		12,801	7,022		13,099	10,565	
5/24/2019	TRUE	TRUE	FALSE	3.55	8.69	6.47	55%	41%	74%		1.34	6.58	7.04									13,099	10,565					13,099	10,565	
5/25/2019	TRUE	TRUE	TRUE	3.65	8.52	6.21	59%	43%	73%		1.37	6.57	6.91									13,467	10,735					13,467	10,735	
5/26/2019	TRUE	TRUE	TRUE	4.14	11.08	8.00	52%	37%	72%		1.39	6.62	7.03									13,467	10,735					13,467	10,735	
5/27/2019	TRUE	TRUE	FALSE	4.24	9.77	7.47	57%	43%	76%		1.31	6.65	6.99									13,653	11,054					13,653	11,054	
5/28/2019	TRUE	TRUE	FALSE	3.86	9.61	7.11	54%	40%	74%		1.35	6.68	6.96									13,653	11,054					13,653	11,054	
5/29/2019	TRUE	TRUE	FALSE	3.68	9.51	6.98	53%	39%	73%		1.36	6.70	6.95									13,653	11,054					13,653	11,054	
5/30/2019	TRUE	TRUE	TRUE	3.72	9.17	6.93	54%	41%	76%		1.32	6.72	6.98	219.20	171.00	0.78		12,669	9,883			13,530	10,908		12,669	9,883		13,530	10,908	
5/31/2019	TRUE	TRUE	FALSE	3.61	8.81	6.55	55%	41%	74%		1.35	6.72	6.97									13,530	10,908					13,530	10,908	
6/1/2019	TRUE	TRUE	FALSE	3.69	8.28	6.31	58%	45%	76%		1.31	6.73	6.95									13,397	10,830					13,397	10,830	
6/2/2019	TRUE	TRUE	TRUE	3.51	8.49	6.24	56%	41%	73%		1.36	6.72	6.95									13,984	10,986					13,984	10,986	
6/3/2019	TRUE	TRUE	FALSE	3.57	8.56	6.37	56%	42%	74%		1.34	6.72	6.75									13,984	10,986					13,984	10,986	
6/4/2019	TRUE	TRUE	FALSE	3.51	8.72	6.19	57%	40%	71%		1.41	6.72	6.59									13,984	10,986					13,984	10,986	
6/5/2019	TRUE	TRUE	FALSE	3.47	8.49	6.10	57%	41%	72%		1.39	6.72	6.46	255.50	256.00	1.00		12,998	13,024			13,843	11,277		12,998	13,024		13,843	11,277	
6/6/2019	TRUE	TRUE	FALSE	3.59	8.19	6.07	59%	44%	74%		1.35	6.71	6.35	255.40	236.00	0.92		12,929	11,947			13,729	11,360		12,929	11,947		13,729	11,360	
6/7/2019	TRUE	TRUE	FALSE	3.26	7.70	5.84	56%	42%	76%		1.32	6.70	6.21									13,729	11,360					13,729	11,360	
6/8/2019	TRUE	TRUE	FALSE	3.50	7.77	5.72	61%	45%	74%		1.36	6.68	6.11									13,536	11,531					13,536	11,531	
6/9/2019	TRUE	TRUE	FALSE	3.27	7.38	5.59	58%	44%	76%		1.32	6.65	6.02									13,829	11,271					13,829	11,271	
6/10/2019	TRUE	TRUE	FALSE	3.41	7.75	5.79	59%	44%	75%		1.34	6.64	5.96									13,829	11,271					13,829	11,271	
6/11/2019	TRUE	TRUE	FALSE	3.45	8.03	5.78	60%	43%	72%		1.39	6.63	5.89									13,829	11,271					13,829	11,271	
6/12/2019	TRUE	TRUE	FALSE	3.39	7.89	5.84	58%	43%	74%		1.35	6.62	5.84									13,829	11,271					13,829	11,271	
6/13/2019	TRUE	TRUE	FALSE	3.44	7.91	5.97	58%	43%	75%		1.32	6.61	5.83	295.50	139.00	0.47		14,713	6,921			13,955	10,650		14,713	6,921		13,955	10,650	
6/14/2019	TRUE	TRUE	FALSE	3.49	7.66	5.88	59%	46%	77%		1.30	6.60	5.80	268.00	206.00	0.77		13,143	10,102			13,853	10,581		13,143	10,102		13,853	10,581	
6/15/2019	TRUE	TRUE	FALSE	3.55	7.76	5.77	62%	46%	74%		1.34	6.57	5.79									13,853	10,581					13,853	10,581	
6/16/2019	TRUE	TRUE	FALSE	3.41	7.71	5.59	61%	44%	73%		1.38	6.47	5.78									13,165	9,993					13,165	9,993	
6/17/2019	TRUE	TRUE	FALSE	3.52	7.63	5.85	60%	46%	77%		1.30	6.43	5.81									13,165	9,993					13,165	9,993	
6/18/2019	TRUE	TRUE	FALSE	3.58	7.92	5.85	61%	45%	74%		1.35	6.39	5.82									13,165	9,993					13,165	9,993	
6/19/2019	TRUE	TRUE	FALSE	3.42	7.87	5.86	58%	43%	74%		1.34	6.33	5.83	266.00	124.00	0.47		13,000	6,060			13,145	9,501		13,000	6,060		13,145	9,501	
6/20/2019	TRUE	TRUE	FALSE	3.49	7.97	5.88	59%	44%	74%		1.36	6.28	5.83	264.70	136.00	0.51		12,981	6,669			13,126	9,187		12,981	6,669		13,126	9,187	
6/21/2019	TRUE	TRUE	FALSE	3.46	7.87	5.72	60%	44%	73%		1.38	6.24	5.80									13,126	9,187					13,126	9,187	
6/22/2019	TRUE	TRUE	FALSE	3.44	7.51	5.59	62%	46%	74%		1.34	6.20	5.76									13,154	8,954					13,154	8,954	
6/23/2019	TRUE	TRUE	FALSE	3.61	7.84	5.69	63%	46%	73%		1.38	6.17	5.75									13,205	9,229					13,205	9,229	
6/24/2019	TRUE	TRUE	FALSE	3.41	7.92	5.79	59%	43%	73%		1.37	6.15	5.78									13,205	9,229					13,205	9,229	
6/25/2019	TRUE	TRUE	FALSE	3.65	8.06	5.86	62%	45%	73%		1.38	6.1																		

Date	Butte Break?	CSU Break?	Precip?	Min Influent Flow, mgd	Max Influent Flow, mgd	Avg Influent Flow, mgd	Min % of Avg	Min % of Max	Avg % of Max	Flow Outlier Type	Diurnal Peak Factor (DPF)	30-d Avg of Avg Flow, mgd	7-d Avg of Avg Flow, mgd	Influent TSS Conc., mg/L	Influent BOD Conc., mg/L	BOD/TSS Ratio	Influent NH3-N Conc., mg/L	Avg Inf TSS Load, ppd	Avg Inf BOD Load, ppd	Avg Inf NH3 Load, ppd	Load Outlier Type	30-d Avg of TSS Load, ppd	30-d Avg of BOD Load, ppd	30-d Avg of NH3-N Load, ppd	non-SN TSS Load, ppd	non-SN BOD Load, ppd	non-SN NH3 Load, ppd	30-d Avg of non-SN TSS Load, ppd	30-d Avg of non-SN BOD Load, ppd	30-d Avg of non-SN NH3-N Load, ppd
7/4/2019	TRUE	TRUE	FALSE	3.49	7.33	5.32	66%	48%	73%		1.38	5.79	5.68									13,256	9,259				13,256	9,259		
7/5/2019	TRUE	TRUE	FALSE	3.41	7.12	5.23	65%	48%	73%		1.36	5.76	5.60	233.00	231.00	0.99		10,163	10,076			12,946	9,361		10,163	10,076		12,946	9,361	
7/6/2019	TRUE	TRUE	FALSE	3.45	7.18	5.40	64%	48%	75%		1.33	5.74	5.55									12,941	8,838				12,941	8,838		
7/7/2019	TRUE	TRUE	FALSE	3.37	7.34	5.53	61%	46%	75%		1.33	5.72	5.55									12,942	8,319				12,942	8,319		
7/8/2019	TRUE	TRUE	FALSE	3.38	7.66	5.86	58%	44%	77%		1.31	5.72	5.59									12,942	8,319				12,942	8,319		
7/9/2019	TRUE	TRUE	FALSE	3.47	8.03	5.84	59%	43%	73%		1.38	5.73	5.59									12,942	8,319				12,942	8,319		
7/10/2019	TRUE	TRUE	FALSE	3.48	8.03	5.80	60%	43%	72%		1.38	5.73	5.59									12,942	8,319				12,942	8,319		
7/11/2019	TRUE	TRUE	FALSE	3.63	8.04	5.83	62%	45%	73%		1.38	5.73	5.60	284.50	266.00	0.93		13,833	12,934			13,041	8,978		13,833	12,934		13,041	8,978	
7/12/2019	TRUE	TRUE	FALSE	3.47	7.77	5.76	60%	45%	74%		1.35	5.73	5.66	247.40	304.00	1.23		11,885	14,604			12,925	9,682		11,885	14,604		12,925	9,682	
7/13/2019	TRUE	TRUE	FALSE	3.54	7.23	5.51	64%	49%	76%		1.31	5.72	5.69									12,925	9,682				12,925	9,682		
7/14/2019	TRUE	TRUE	FALSE	3.45	7.08	5.48	63%	49%	77%		1.29	5.71	5.70									12,727	10,076				12,727	10,076		
7/15/2019	TRUE	TRUE	FALSE	3.61	7.78	5.73	63%	46%	74%		1.36	5.70	5.73									12,675	10,072				12,675	10,072		
7/16/2019	TRUE	TRUE	FALSE	3.61	7.65	5.72	63%	47%	75%		1.34	5.70	5.71									12,675	10,072				12,675	10,072		
7/17/2019	TRUE	TRUE	FALSE	3.72	7.60	5.73	65%	49%	75%		1.33	5.71	5.70	266.80	209.00	0.78		12,750	9,988			12,683	10,060		12,750	9,988		12,683	10,060	
7/18/2019	TRUE	TRUE	FALSE	3.65	7.68	5.79	63%	48%	75%		1.33	5.70	5.69									12,683	10,060				12,683	10,060		
7/19/2019	TRUE	TRUE	FALSE	3.53	7.59	5.80	61%	47%	76%		1.31	5.70	5.69	260.30	259.00	1.00		12,591	12,528			12,674	10,368		12,591	12,528		12,674	10,368	
7/20/2019	TRUE	TRUE	FALSE	3.62	7.29	5.60	65%	50%	77%		1.30	5.69	5.67									12,638	10,984				12,638	10,984		
7/21/2019	TRUE	TRUE	FALSE	3.50	7.11	5.54	63%	49%	78%		1.28	5.68	5.67									12,595	11,703				12,595	11,703		
7/22/2019	TRUE	TRUE	FALSE	3.50	7.68	5.76	61%	46%	75%		1.33	5.68	5.71									12,595	11,703				12,595	11,703		
7/23/2019	TRUE	TRUE	FALSE	3.68	7.89	5.77	64%	47%	73%		1.37	5.69	5.71									12,595	11,703				12,595	11,703		
7/24/2019	TRUE	TRUE	FALSE	3.54	7.52	5.65	63%	47%	75%		1.33	5.69	5.71	262.50	258.00	0.98		12,369	12,157			12,570	11,768		12,369	12,157		12,570	11,768	
7/25/2019	TRUE	TRUE	FALSE	3.60	7.62	5.77	62%	47%	76%		1.32	5.69	5.71									12,570	11,768				12,570	11,768		
7/26/2019	TRUE	TRUE	FALSE	3.56	7.69	5.71	62%	46%	74%		1.35	5.68	5.70									12,570	11,768				12,570	11,768		
7/27/2019	TRUE	TRUE	FALSE	3.56	7.19	5.50	65%	50%	76%		1.31	5.67	5.66									12,438	11,768				12,438	11,768		
7/28/2019	TRUE	TRUE	FALSE	3.47	6.92	5.40	64%	50%	78%		1.28	5.65	5.64									12,217	12,048				12,217	12,048		
7/29/2019	TRUE	TRUE	FALSE	3.53	7.51	5.74	61%	47%	76%		1.31	5.65	5.66									12,217	12,048				12,217	12,048		
7/30/2019	TRUE	TRUE	FALSE	3.55	7.73	5.76	62%	46%	75%		1.34	5.66	5.66									12,217	12,048				12,217	12,048		
7/31/2019	TRUE	TRUE	FALSE	3.63	7.79	5.73	63%	47%	74%		1.36	5.66	5.66									12,217	12,048				12,217	12,048		
8/1/2019	TRUE	TRUE	FALSE	3.63	7.55	5.77	63%	48%	76%		1.31	5.66	5.67	182.00	323.00	1.77		8,758	15,543			11,784	12,547		8,758	15,543		11,784	12,547	
8/2/2019	TRUE	TRUE	FALSE	3.53	7.70	5.72	62%	46%	74%		1.35	5.66	5.67	569.60	380.00	0.67		27,173	18,128			13,494	13,245		27,173	18,128		13,494	13,245	
8/3/2019	TRUE	TRUE	FALSE	3.48	7.12	5.44	64%	49%	76%		1.31	5.65	5.63									13,690	13,245				13,690	13,245		
8/4/2019	TRUE	TRUE	FALSE	3.46	7.21	5.57	62%	48%	77%		1.29	5.66	5.64									13,690	13,245				13,690	13,245		
8/5/2019	TRUE	TRUE	FALSE	3.57	7.64	5.80	62%	47%	76%		1.32	5.68	5.69									14,194	13,697				14,194	13,697		
8/6/2019	TRUE	TRUE	FALSE	3.54	7.98	5.74	62%	44%	72%		1.39	5.69	5.69									14,194	13,697				14,194	13,697		
8/7/2019	TRUE	TRUE	FALSE	3.53	7.76	5.78	61%	45%	74%		1.34	5.70	5.69	126.60	403.00	3.18		6,103	19,427			13,183	14,414		6,103	19,427		13,183	14,414	
8/8/2019	TRUE	TRUE	FALSE	3.57	7.84	5.87	61%	46%	75%		1.34	5.70	5.71	268.00	366.00	1.37		13,120	17,918			13,176	14,803		13,120	17,918		13,176	14,803	
8/9/2019	TRUE	TRUE	FALSE	3.54	7.51	5.52	64%	47%	74%		1.36	5.69	5.68									13,176	14,803				13,176	14,803		
8/10/2019	TRUE	TRUE	FALSE	3.43	7.31	5.67	60%	47%	78%		1.29	5.68	5.67									13,176	14,803				13,176	14,803		
8/11/2019	TRUE	TRUE	FALSE	3.43	7.23	5.61	61%	47%	78%		1.29	5.68	5.70									13,094	15,037				13,094	15,037		
8/12/2019	TRUE	TRUE	FALSE	3.56	7.40	5.82	61%	48%	79%		1.27	5.68	5.73									13,266	15,098				13,266	15,098		
8/13/2019	TRUE	TRUE	FALSE	3.58	8.00	5.91	61%	45%	74%		1.35	5.69	5.74									13,266	15,098				13,266	15,098		
8/14/2019	TRUE	TRUE	FALSE	3.46	8.23	6.03	57%	42%	73%		1.36	5.71	5.78	628.90	189.00	0.30		31,628	9,505			15,561	14,399		31,628	9,505		15,561	14,399	
8/15/2019	TRUE	TRUE	FALSE	3.57	8.89	6.03	59%	40%	68%		1.47	5.72	5.81	295.80	240.00	0.81		14,876	12,070			15,485	14,140		14,876	12,070		15,485	14,140	
8/16/2019	TRUE	TRUE	FALSE	3.51	8.01	5.86	60%	44%	73%		1.37	5.72	5.81									15,485	14,140				15,485	14,140		
8/17/2019	TRUE	TRUE	FALSE	3.40	7.80	5.78	59%	44%	74%		1.35	5.72	5.84									15,827	14,659				15,827	14,659		
8/18/2019	TRUE	TRUE	FALSE	3.28	8.22	5.88	56%	40%	72%		1.40	5.73	5.87									15,827	14,659				15,827	14,659		
8/19/2019	TRUE	TRUE	FALSE	3.34	11.04	6.20	54%	30%	56%	AvgMax	1.78	5.72	5.90									16,289	14,964				16,289	14,964		
8/20/2019	TRUE	TRUE	FALSE	3.40	8.35	6.13	55%	41%	73%		1.36	5.74	5.95									16,289	14,964				16,289	14,964		
8/21/2019	TRUE	TRUE	FALSE	3.53	8.62	6.29	56%	41%	73%		1.37	5.77	6.00	322.20	214.00	0.66		16,902	11,226			16,366	14,497		16,902	11,226		16,366	14,497	
8/22/2019	TRUE	TRUE	FALSE	3.40	8.89	6.18	55%	38%	70%		1.44	5.78	6.02	317.20	231.00	0.73		16,349	11,906			16,364	14,209		16,349	11,906		16,364	14,209	
8/23/2019	TRUE	TRUE	FALSE	3.56	8.65	6.19	58%	41%	72%		1.40	5.80	6.04									16,364	14,209				16,364	14,209		
8/24/2019	TRUE	TRUE	FALSE	3.35	8.62	6.05	55%	39%	70%		1.42	5.81	6.07									16,864	14,465				16,864	14,465		
8/25/2019	TRUE	TRUE	FALSE	3.30	8.75	6.15	54%	38%	70%		1.42	5.82	6.12									16,864	14,465				16,864	14,465		
8/26/2019	TRUE	TRUE	FALSE	3.37	9.01	6.23	54%	37%	69%		1.45	5.84	6.17									16,864	14,465				16,864	14,465		
8/2																														

Date	Butte Break?	CSU Break?	Precip?	Min Influent Flow, mgd	Max Influent Flow, mgd	Avg Influent Flow, mgd	Min % of Avg	Min % of Max	Avg % of Max	Flow Outlier Type	Diurnal Peak Factor (DPF)	30-d Avg of Avg Flow, mgd	7-d Avg of Avg Flow, mgd	Influent TSS Conc., mg/L	Influent BOD Conc., mg/L	BOD/TSS Ratio	Influent NH3-N Conc., mg/L	Avg Inf TSS Load, ppd	Avg Inf BOD Load, ppd	Avg Inf NH3 Load, ppd	Load Outlier Type	30-d Avg of TSS Load, ppd	30-d Avg of BOD Load, ppd	30-d Avg of NH3-N Load, ppd	non-SN TSS Load, ppd	non-SN BOD Load, ppd	non-SN NH3 Load, ppd	30-d Avg of non-SN TSS Load, ppd	30-d Avg of non-SN BOD Load, ppd	30-d Avg of non-SN NH3-N Load, ppd
9/5/2019	FALSE	FALSE	FALSE	3.46	9.35	6.26	55%	37%	67%		1.49	6.02	6.15	289.00	144.00	0.50		15,088	7,518			16,403	12,329		15,088	7,518		16,403	12,329	
9/6/2019	FALSE	FALSE	FALSE	3.36	8.73	6.21	54%	38%	71%		1.41	6.03	6.14									16,403	12,329					16,403	12,329	
9/7/2019	FALSE	FALSE	FALSE	3.47	8.87	6.22	56%	39%	70%		1.43	6.05	6.14									17,691	11,442					17,691	11,442	
9/8/2019	FALSE	FALSE	FALSE	3.21	9.05	6.18	52%	35%	68%		1.46	6.06	6.17									18,344	10,517					18,344	10,517	
9/9/2019	FALSE	FALSE	FALSE	3.30	8.98	6.27	53%	37%	70%		1.43	6.08	6.24									18,344	10,517					18,344	10,517	
9/10/2019	FALSE	FALSE	FALSE	3.53	9.33	6.33	56%	38%	68%		1.47	6.10	6.27									18,344	10,517					18,344	10,517	
9/11/2019	FALSE	FALSE	FALSE	3.36	8.93	6.23	54%	38%	70%		1.43	6.12	6.26	276.00	289.00	1.05		14,340	15,016			17,844	11,079		14,340	15,016		17,844	11,079	
9/12/2019	FALSE	FALSE	FALSE	3.35	8.79	6.27	53%	38%	71%		1.40	6.14	6.25	208.70	323.00	1.55		10,913	16,890			17,074	11,725		10,913	16,890		17,074	11,725	
9/13/2019	FALSE	FALSE	FALSE	3.48	8.79	6.30	55%	40%	72%		1.40	6.15	6.25									17,074	11,725					17,074	11,725	
9/14/2019	FALSE	FALSE	FALSE	3.49	8.73	6.07	57%	40%	70%		1.44	6.15	6.23									15,254	12,002					15,254	12,002	
9/15/2019	FALSE	FALSE	FALSE	3.33	8.60	6.15	54%	39%	72%		1.40	6.16	6.23									15,308	11,992					15,308	11,992	
9/16/2019	FALSE	FALSE	TRUE	3.41	8.97	6.34	54%	38%	71%		1.41	6.17	6.25									15,308	11,992					15,308	11,992	
9/17/2019	FALSE	FALSE	FALSE	3.40	8.90	6.30	54%	38%	71%		1.41	6.19	6.25									15,308	11,992					15,308	11,992	
9/18/2019	FALSE	FALSE	TRUE	3.45	9.12	6.48	53%	38%	71%		1.41	6.21	6.27	263.60	229.00	0.87		14,246	12,376			15,176	12,040		14,246	12,376		15,176	12,040	
9/19/2019	FALSE	FALSE	TRUE	3.40	9.19	6.40	53%	37%	70%		1.44	6.22	6.29	250.00	187.00	0.75		13,344	9,981			14,972	11,812		13,344	9,981		14,972	11,812	
9/20/2019	FALSE	FALSE	FALSE	3.38	9.02	6.30	54%	37%	70%		1.43	6.22	6.29									14,972	11,812					14,972	11,812	
9/21/2019	FALSE	FALSE	FALSE	3.35	8.34	6.09	55%	40%	73%		1.37	6.22	6.27									14,731	11,885					14,731	11,885	
9/22/2019	FALSE	FALSE	FALSE	3.38	8.79	6.18	55%	38%	70%		1.42	6.22	6.28									14,500	11,882					14,500	11,882	
9/23/2019	FALSE	FALSE	FALSE	3.35	9.21	6.27	53%	36%	68%		1.47	6.22	6.30									14,500	11,882					14,500	11,882	
9/24/2019	FALSE	FALSE	FALSE	3.24	8.93	6.20	52%	36%	69%		1.44	6.22	6.28									14,500	11,882					14,500	11,882	
9/25/2019	FALSE	FALSE	FALSE	3.45	9.19	6.35	54%	38%	69%		1.45	6.23	6.28									14,500	11,882					14,500	11,882	
9/26/2019	FALSE	FALSE	FALSE	3.44	9.02	6.27	55%	38%	70%		1.44	6.23	6.26	273.90	269.00	0.98		14,323	14,066			14,478	12,155		14,323	14,066		14,478	12,155	
9/27/2019	FALSE	FALSE	FALSE	3.44	8.96	6.37	54%	38%	71%		1.41	6.23	6.25									14,478	12,155					14,478	12,155	
9/28/2019	FALSE	FALSE	FALSE	3.38	8.41	6.04	56%	40%	72%		1.39	6.23	6.22									14,478	12,155					14,478	12,155	
9/29/2019	FALSE	FALSE	TRUE	3.30	9.01	6.31	52%	37%	70%		1.43	6.23	6.25									14,283	12,705					14,283	12,705	
9/30/2019	FALSE	FALSE	FALSE	3.27	8.95	6.37	51%	37%	71%		1.41	6.23	6.27									14,283	12,705					14,283	12,705	
10/1/2019	FALSE	FALSE	FALSE	3.30	9.20	6.30	52%	36%	68%		1.46	6.24	6.28									14,283	12,705					14,283	12,705	
10/2/2019	FALSE	FALSE	FALSE	3.48	9.43	6.32	55%	37%	67%		1.49	6.26	6.29	317.60	246.00	0.77		16,740	12,966			14,591	12,738		16,740	12,966		14,591	12,738	
10/3/2019	FALSE	FALSE	FALSE	3.37	9.18	6.29	54%	37%	69%		1.46	6.27	6.28	256.00	297.00	1.16		13,429	15,580			14,462	13,054		13,429	15,580		14,462	13,054	
10/4/2019	FALSE	FALSE	FALSE	3.48	9.02	6.29	55%	39%	70%		1.43	6.27	6.29									14,462	13,054					14,462	13,054	
10/5/2019	FALSE	FALSE	FALSE	3.37	8.89	6.10	55%	38%	69%		1.46	6.26	6.25									14,053	13,049					14,053	13,049	
10/6/2019	FALSE	FALSE	FALSE	3.19	8.84	6.12	52%	36%	69%		1.44	6.26	6.26									13,905	13,839					13,905	13,839	
10/7/2019	FALSE	FALSE	FALSE	3.28	8.94	6.45	51%	37%	72%		1.39	6.26	6.28									13,905	13,839					13,905	13,839	
10/8/2019	FALSE	FALSE	FALSE	3.39	9.23	6.30	54%	37%	68%		1.47	6.27	6.27									13,905	13,839					13,905	13,839	
10/9/2019	FALSE	FALSE	FALSE	3.38	9.23	6.21	54%	37%	67%		1.49	6.27	6.26	256.30	283.00	1.10		13,274	14,657			13,826	13,942		13,274	14,657		13,826	13,942	
10/10/2019	FALSE	FALSE	FALSE	3.34	8.64	6.26	53%	39%	72%		1.38	6.27	6.25	271.00	336.00	1.24		14,148	17,542			13,862	14,342		14,148	17,542		13,862	14,342	
10/11/2019	FALSE	FALSE	FALSE	3.30	8.85	6.15	54%	37%	69%		1.44	6.26	6.24									13,862	14,342					13,862	14,342	
10/12/2019	FALSE	FALSE	FALSE	3.35	8.86	6.11	55%	38%	69%		1.45	6.26	6.21									13,802	14,257					13,802	14,257	
10/13/2019	FALSE	FALSE	FALSE	3.27	9.19	6.18	53%	36%	67%		1.49	6.25	6.22									14,215	13,881					14,215	13,881	
10/14/2019	FALSE	FALSE	FALSE	3.36	8.99	6.30	53%	37%	70%		1.43	6.25	6.25									14,215	13,881					14,215	13,881	
10/15/2019	FALSE	FALSE	FALSE	3.29	9.11	6.16	53%	36%	68%		1.48	6.26	6.21									14,215	13,881					14,215	13,881	
10/16/2019	FALSE	FALSE	TRUE	3.32	9.04	6.29	53%	37%	70%		1.44	6.26	6.21	274.50	322.00	1.17		14,400	16,892			14,238	14,258		14,400	16,892		14,238	14,258	
10/17/2019	FALSE	FALSE	FALSE	3.38	9.13	6.31	54%	37%	69%		1.45	6.26	6.22	307.00	366.00	1.19		16,156	19,261			14,451	14,814		16,156	19,261		14,451	14,814	
10/18/2019	FALSE	FALSE	FALSE	3.36	8.77	6.25	54%	38%	71%		1.40	6.26	6.22									14,451	14,814					14,451	14,814	
10/19/2019	FALSE	FALSE	FALSE	3.33	8.74	6.16	54%	38%	70%		1.42	6.25	6.22									14,477	15,118					14,477	15,118	
10/20/2019	FALSE	FALSE	FALSE	3.27	8.87	6.20	53%	37%	70%		1.43	6.24	6.23									14,639	15,852					14,639	15,852	
10/21/2019	FALSE	FALSE	FALSE	3.23	8.69	6.25	52%	37%	72%		1.39	6.24	6.24									14,639	15,852					14,639	15,852	
10/22/2019	FALSE	FALSE	FALSE	3.23	9.18	6.22	52%	35%	68%		1.48	6.24	6.23	323.20				16,766				14,905	15,852		16,443			14,864	15,852	
10/23/2019	FALSE	FALSE	FALSE	3.45	8.93	6.27	55%	39%	70%		1.42	6.25	6.24		122.00				6,380			14,905	14,668			6,380		14,864	14,668	
10/24/2019	FALSE	FALSE	FALSE	3.40	9.00	6.28	54%	38%	70%		1.43	6.25	6.24	281.10	248.00	0.88		14,723	12,989			14,884	14,481		14,723	12,989		14,849	14,481	
10/25/2019	FALSE	FALSE	FALSE	3.31	8.89	6.26	53%	37%	70%		1.42	6.25	6.24									14,884	14,481					14,849	14,481	
10/26/2019	FALSE	FALSE	FALSE	3.44	9.07	6.19	56%	38%	68%		1.47	6.24	6.23									14,884	14,481					14,849	14,481	
10/27/2019	FALSE	FALSE	FALSE	3.30	9.08	6.23	53%	36%	69%		1.46	6.24	6.24									14,955	14,533					14,914	14,533	
10/28/2019	FALSE	FALSE	FALSE	3.25	9.14	6.41	51%	36%	70%		1.43	6.24	6.26									14,955	14,533					14,914	14,533	
10/29/2019	FALSE</																													

Date	Butte Break?	CSU Break?	Precip?	Min Influent Flow, mgd	Max Influent Flow, mgd	Avg Influent Flow, mgd	Min % of Avg	Min % of Max	Avg % of Max	Flow Outlier Type	Diurnal Peak Factor (DPF)	30-d Avg of Avg Flow, mgd	7-d Avg of Avg Flow, mgd	Influent TSS Conc., mg/L	Influent BOD Conc., mg/L	BOD/TSS Ratio	Influent NH3-N Conc., mg/L	Avg Inf TSS Load, ppd	Avg Inf BOD Load, ppd	Avg Inf NH3 Load, ppd	Load Outlier Type	30-d Avg of TSS Load, ppd	30-d Avg of BOD Load, ppd	30-d Avg of NH3-N Load, ppd	non-SN TSS Load, ppd	non-SN BOD Load, ppd	non-SN NH3 Load, ppd	30-d Avg of non-SN TSS Load, ppd	30-d Avg of non-SN BOD Load, ppd	30-d Avg of non-SN NH3-N Load, ppd
11/7/2019	FALSE	FALSE	FALSE	3.38	9.14	6.40	53%	37%	70%		1.43	6.27	6.31									15,037	13,903				14,997	13,903		
11/8/2019	FALSE	FALSE	FALSE	3.41	9.00	6.35	54%	38%	71%		1.42	6.27	6.32	260.10	295.00	1.13		13,775	15,623			14,897	14,094		13,775	15,623		14,861	14,094	
11/9/2019	FALSE	FALSE	FALSE	3.39	8.98	6.17	55%	38%	69%		1.46	6.27	6.30									15,100	14,024				15,060	14,024		
11/10/2019	FALSE	FALSE	FALSE	3.30	8.67	6.00	55%	38%	69%		1.45	6.26	6.27									15,236	13,521				15,190	13,521		
11/11/2019	FALSE	FALSE	FALSE	3.35	9.31	6.40	52%	36%	69%		1.45	6.27	6.28									15,236	13,521				15,190	13,521		
11/12/2019	FALSE	FALSE	FALSE	3.36	9.19	6.36	53%	37%	69%		1.44	6.27	6.29									15,236	13,521				15,190	13,521		
11/13/2019	FALSE	FALSE	FALSE	3.37	9.32	6.36	53%	36%	68%		1.47	6.28	6.30	272.10	296.00	1.09		14,433	15,701			15,135	13,793		14,433	15,701		15,095	13,793	
11/14/2019	FALSE	FALSE	FALSE	3.40	9.24	6.37	53%	37%	69%		1.45	6.28	6.30	278.40	362.00	1.30		14,790	19,232			15,097	14,398		14,790	19,232		15,061	14,398	
11/15/2019	FALSE	FALSE	FALSE	3.33	8.92	6.36	52%	37%	71%		1.40	6.29	6.30									15,097	14,398				15,061	14,398		
11/16/2019	FALSE	FALSE	FALSE	3.43	9.50	6.36	54%	36%	67%		1.49	6.29	6.30									15,184	14,086				15,144	14,086		
11/17/2019	FALSE	FALSE	FALSE	3.32	9.31	6.38	52%	36%	69%		1.46	6.29	6.32									15,045	13,347				14,999	13,347		
11/18/2019	FALSE	FALSE	FALSE	3.35	9.17	6.38	53%	37%	70%		1.44	6.30	6.37									15,045	13,347				14,999	13,347		
11/19/2019	FALSE	FALSE	FALSE	3.37	9.14	6.34	53%	37%	69%		1.44	6.30	6.36									15,045	13,347				14,999	13,347		
11/20/2019	FALSE	FALSE	FALSE	3.35	9.20	6.29	53%	36%	68%		1.46	6.31	6.36									15,045	13,347				14,999	13,347		
11/21/2019	TRUE	FALSE	FALSE	3.38	9.17	6.38	53%	37%	70%		1.44	6.31	6.36	286.60				15,250				15,071	13,347		15,250		15,031	13,347		
11/22/2019	TRUE	TRUE	FALSE	3.39	8.86	6.22	55%	38%	70%		1.42	6.31	6.34	241.10	260.00	1.08		12,507	13,487			14,539	13,364		12,507	13,487		14,539	13,364	
11/23/2019	TRUE	TRUE	FALSE	3.20	8.27	6.04	53%	39%	73%		1.37	6.30	6.30									14,539	14,362				14,539	14,362		
11/24/2019	TRUE	TRUE	FALSE	3.27	8.03	5.85	56%	41%	73%		1.37	6.29	6.24									14,512	14,591				14,512	14,591		
11/25/2019	TRUE	TRUE	FALSE	3.31	8.17	5.98	55%	41%	73%		1.37	6.28	6.19									14,512	14,591				14,512	14,591		
11/26/2019	TRUE	TRUE	TRUE	3.33	9.07	6.26	53%	37%	69%		1.45	6.28	6.17									14,512	14,591				14,512	14,591		
11/27/2019	TRUE	TRUE	FALSE	3.54	8.85	6.39	55%	40%	72%		1.38	6.29	6.18	307.30	360.00	1.17		16,377	19,185			14,745	15,247		16,377	19,185		14,745	15,247	
11/28/2019	TRUE	TRUE	TRUE	3.34	8.31	5.79	58%	40%	70%		1.44	6.27	6.11									14,745	15,247				14,745	15,247		
11/29/2019	TRUE	TRUE	FALSE	3.31	7.45	5.53	60%	44%	74%		1.35	6.24	6.01									14,745	15,247				14,745	15,247		
11/30/2019	TRUE	TRUE	TRUE	3.34	8.06	5.93	56%	41%	74%		1.36	6.22	5.97									14,749	15,760				14,749	15,760		
12/1/2019	TRUE	TRUE	TRUE	4.14	11.67	7.76	53%	35%	66%		1.50	6.27	6.19									14,522	16,646				14,522	16,646		
12/2/2019	TRUE	TRUE	TRUE	6.54	12.70	10.30	63%	51%	81%		1.23	6.40	6.74									14,522	16,646				14,522	16,646		
12/3/2019	FALSE	FALSE	FALSE	5.61	11.46	8.48	66%	49%	74%		1.35	6.47	7.06									14,522	16,646				14,522	16,646		
12/4/2019	FALSE	FALSE	TRUE	4.46	10.78	7.57	59%	41%	70%		1.42	6.51	7.22	197.80	368.00	1.86		12,488	23,233			14,231	17,744		12,488	23,233		14,231	17,744	
12/5/2019	FALSE	FALSE	TRUE	4.10	10.04	7.26	56%	41%	72%		1.38	6.54	7.33	220.00	362.00	1.65		13,321	21,919			14,117	18,340		13,321	21,919		14,117	18,340	
12/6/2019	FALSE	FALSE	TRUE	3.99	9.85	7.04	57%	41%	71%		1.40	6.57	7.48									14,117	18,340				14,117	18,340		
12/7/2019	FALSE	FALSE	TRUE	4.24	10.17	7.53	56%	42%	74%		1.35	6.61	7.73									14,117	18,340				14,117	18,340		
12/8/2019	FALSE	FALSE	TRUE	4.15	10.37	7.48	55%	40%	72%		1.39	6.64	7.93									14,117	18,340				14,117	18,340		
12/9/2019	FALSE	FALSE	FALSE	3.98	10.07	7.14	56%	40%	71%		1.41	6.67	7.85									14,166	18,793				14,166	18,793		
12/10/2019	FALSE	FALSE	TRUE	3.81	9.84	6.98	55%	39%	71%		1.41	6.69	7.44									14,166	18,793				14,166	18,793		
12/11/2019	FALSE	FALSE	TRUE	3.91	10.72	7.26	54%	36%	68%		1.48	6.73	7.28	245.60	301.00	1.23		14,871	18,225			14,254	18,712		14,871	18,225		14,254	18,712	
12/12/2019	FALSE	FALSE	TRUE	4.98	10.79	8.19	61%	46%	76%		1.32	6.79	7.36	239.80	297.00	1.24		16,379	20,286			14,491	18,909		16,379	20,286		14,491	18,909	
12/13/2019	FALSE	FALSE	TRUE	4.41	10.23	7.57	58%	43%	74%		1.35	6.83	7.40									14,491	18,909				14,491	18,909		
12/14/2019	FALSE	FALSE	TRUE	3.88	10.00	7.32	53%	39%	73%		1.37	6.86	7.43									14,498	19,367				14,498	19,367		
12/15/2019	FALSE	TRUE	FALSE	3.93	10.37	7.32	54%	38%	71%		1.42	6.89	7.41									14,456	19,389				14,456	19,389		
12/16/2019	FALSE	TRUE	FALSE	3.77	10.02	7.10	53%	38%	71%		1.41	6.92	7.36									14,456	19,389				14,456	19,389		
12/17/2019	FALSE	TRUE	FALSE	3.60	9.83	6.99	52%	37%	71%		1.41	6.94	7.34									14,456	19,389				14,456	19,389		
12/18/2019	FALSE	TRUE	TRUE	3.49	9.71	7.07	49%	36%	73%		1.37	6.96	7.35	255.60	198.00	0.77		15,071	11,675			14,533	18,287		14,805	11,564		14,500	18,271	
12/19/2019	TRUE	TRUE	TRUE	3.97	9.65	7.36	54%	41%	76%		1.31	6.99	7.37									14,533	18,287				14,500	18,271		
12/20/2019	TRUE	TRUE	FALSE	3.93	9.41	7.10	55%	42%	75%		1.33	7.02	7.23									14,533	18,287				14,500	18,271		
12/21/2019	TRUE	TRUE	TRUE	3.69	9.20	6.68	55%	40%	73%		1.38	7.03	7.12									14,533	18,287				14,500	18,271		
12/22/2019	TRUE	TRUE	TRUE	3.51	10.09	7.00	50%	35%	69%		1.44	7.05	7.08									14,431	18,287				14,392	18,271		
12/23/2019	TRUE	TRUE	FALSE	4.56	9.98	7.53	61%	46%	75%		1.33	7.09	7.10									14,751	19,087				14,707	19,069		
12/24/2019	TRUE	TRUE	FALSE	4.11	9.16	7.01	59%	45%	77%		1.31	7.12	7.09									14,751	19,087				14,707	19,069		
12/25/2019	TRUE	TRUE	TRUE	3.70	7.81	5.89	63%	47%	75%		1.33	7.12	6.96									14,751	19,087				14,707	19,069		
12/26/2019	TRUE	TRUE	FALSE	3.48	8.42	6.15	57%	41%	73%		1.37	7.13	6.84									14,751	19,087				14,707	19,069		
12/27/2019	TRUE	TRUE	FALSE	3.51	8.24	6.29	56%	43%	76%		1.31	7.13	6.71									14,751	19,087				14,707	19,069		
12/28/2019	TRUE	TRUE	FALSE	3.47	8.23	6.13	57%	42%	74%		1.34	7.12	6.59	268.30	243.00	0.91		13,717	12,423			14,308	17,960		13,717	12,423		14,263	17,942	
12/29/2019	TRUE	TRUE	TRUE	3.30	8.29	6.02	55%	40%	73%		1.38	7.13	6.50									14,308	17,960				14,263	17,942		
12/30/2019	TRUE	TRUE	TRUE	3.43	8.34	6.23	55%	41%	75%		1.34	7.15	6.41									14,308	17,960				14,263	17,942		
12/31/2019	TRUE	TRUE	FALSE	3.45</																										

Date	Butte Break?	CSU Break?	Precip?	Min Influent Flow, mgd	Max Influent Flow, mgd	Avg Influent Flow, mgd	Min % of Avg	Min % of Max	Avg % of Max	Flow Outlier Type	Diurnal Peak Factor (DPF)	30-d Avg of Avg Flow, mgd	7-d Avg of Avg Flow, mgd	Influent TSS Conc., mg/L	Influent BOD Conc., mg/L	BOD/TSS Ratio	Influent NH3-N Conc., mg/L	Avg Inf TSS Load, ppd	Avg Inf BOD Load, ppd	Avg Inf NH3 Load, ppd	Load Outlier Type	30-d Avg of TSS Load, ppd	30-d Avg of BOD Load, ppd	30-d Avg of NH3-N Load, ppd	non-SN TSS Load, ppd	non-SN BOD Load, ppd	non-SN NH3 Load, ppd	30-d Avg of non-SN TSS Load, ppd	30-d Avg of non-SN BOD Load, ppd	30-d Avg of non-SN NH3-N Load, ppd
1/9/2020	TRUE	TRUE	TRUE	3.41	8.64	6.21	55%	39%	72%		1.39	6.630645	6.05									14,961	14,607				14,908	14,585		
1/10/2020	TRUE	TRUE	FALSE	3.35	8.53	6.14	55%	39%	72%		1.39	6.603548	6.07									14,961	14,607				14,908	14,585		
1/11/2020	TRUE	TRUE	FALSE	3.39	8.06	6.04	56%	42%	75%		1.33	6.564194	6.08	180.80	424.00	2.35		9,108	21,358			13,808	15,234		9,108	21,358	13,755	15,212		
1/12/2020	TRUE	TRUE	FALSE	3.23	8.84	6.03	54%	37%	68%		1.47	6.494516	6.08									13,165	13,971				13,099	13,943		
1/13/2020	TRUE	TRUE	FALSE	3.24	8.70	6.03	54%	37%	69%		1.44	6.444839	6.09									13,165	13,971				13,099	13,943		
1/14/2020	TRUE	TRUE	FALSE	3.22	8.79	5.99	54%	37%	68%		1.47	6.401935	6.08									13,165	13,971				13,099	13,943		
1/15/2020	TRUE	TRUE	FALSE	3.28	8.70	6.17	53%	38%	71%		1.41	6.364839	6.09	383.50	327.00	0.85		19,734	16,827			14,479	14,542		19,734	16,827	14,426	14,520		
1/16/2020	TRUE	TRUE	TRUE	3.34	8.76	6.35	53%	38%	72%		1.38	6.340645	6.12	361.00	330.00	0.91		19,118	17,476			15,252	15,031		19,118	17,476	15,208	15,012		
1/17/2020	TRUE	TRUE	FALSE	3.39	8.66	6.31	54%	39%	73%		1.37	6.31871	6.13									15,252	15,031				15,208	15,012		
1/18/2020	TRUE	TRUE	FALSE	3.31	8.30	6.16	54%	40%	74%		1.35	6.289355	6.14									15,289	15,702				15,289	15,702		
1/19/2020	TRUE	TRUE	FALSE	3.24	8.63	6.12	53%	38%	71%		1.41	6.249355	6.15									15,289	15,702				15,289	15,702		
1/20/2020	TRUE	TRUE	FALSE	3.30	9.51	6.48	51%	35%	68%		1.47	6.229355	6.20									15,289	15,702				15,289	15,702		
1/21/2020	TRUE	TRUE	TRUE	3.34	9.21	6.58	51%	36%	71%		1.40	6.226129	6.27									15,289	15,702				15,289	15,702		
1/22/2020	TRUE	TRUE	FALSE	3.39	9.39	6.59	51%	36%	70%		1.42	6.212903	6.35	278.40	329.00	1.18		15,301	18,082			15,291	16,099		15,234	18,038	15,280	16,091		
1/23/2020	TRUE	FALSE	TRUE	3.42	9.23	6.54	52%	37%	71%		1.41	6.180968	6.39	218.50	410.00	1.88		11,918	22,363			14,809	16,994		11,918	22,363	14,799	16,987		
1/24/2020	TRUE	FALSE	FALSE	3.49	8.93	6.58	53%	39%	74%		1.36	6.167097	6.42									14,809	16,994				14,799	16,987		
1/25/2020	TRUE	FALSE	TRUE	3.62	8.67	6.62	55%	42%	76%		1.31	6.190645	6.46									14,809	16,994				14,799	16,987		
1/26/2020	TRUE	FALSE	TRUE	4.36	10.92	7.88	55%	40%	72%		1.39	6.246452	6.67									14,809	16,994				14,799	16,987		
1/27/2020	TRUE	FALSE	FALSE	4.03	10.93	7.50	54%	37%	69%		1.46	6.285484	6.85									14,809	16,994				14,799	16,987		
1/28/2020	TRUE	FALSE	FALSE	3.80	11.70	7.28	52%	32%	62%		1.61	6.322581	6.95									14,991	17,755				14,980	17,748		
1/29/2020	FALSE	FALSE	FALSE	3.62	10.10	6.92	52%	36%	69%		1.46	6.351613	6.99	378.60	314.00	0.83		21,850	18,122			15,971	17,808		21,850	18,122	15,961	17,801		
1/30/2020	FALSE	FALSE	FALSE	3.54	9.55	6.72	53%	37%	70%		1.42	6.367419	7.01									15,971	17,808				15,961	17,801		
1/31/2020	FALSE	FALSE	FALSE	3.50	9.48	6.58	53%	37%	69%		1.44	6.379677	7.01									15,971	17,808				15,961	17,801		
2/1/2020	FALSE	FALSE	FALSE	3.47	9.17	6.52	53%	38%	71%		1.41	6.404194	7.00									15,971	17,808				15,961	17,801		
2/2/2020	FALSE	FALSE	FALSE	3.21	9.55	6.36	50%	34%	67%		1.50	6.416774	6.97									15,971	17,808				15,961	17,801		
2/3/2020	FALSE	FALSE	FALSE	3.20	9.76	6.35	50%	33%	65%		1.54	6.427742	6.78									16,171	19,038				16,160	19,031		
2/4/2020	FALSE	FALSE	FALSE	3.18	9.59	6.42	50%	33%	67%		1.49	6.441613	6.64									16,171	19,038				16,160	19,031		
2/5/2020	FALSE	FALSE	FALSE	3.25	9.51	6.48	50%	34%	68%		1.47	6.458387	6.54									16,171	19,038				16,160	19,031		
2/6/2020	FALSE	FALSE	FALSE	3.26	9.48	6.31	52%	34%	67%		1.50	6.466129	6.47									16,171	19,038				16,160	19,031		
2/7/2020	FALSE	FALSE	FALSE	3.23	9.11	6.20	52%	35%	68%		1.47	6.469677	6.40	370.90	254.00	0.68		19,178	13,134			16,601	18,195		19,178	13,134	16,591	18,188		
2/8/2020	FALSE	FALSE	FALSE	3.21	8.78	6.17	52%	37%	70%		1.42	6.471935	6.35									16,601	18,195				16,591	18,188		
2/9/2020	FALSE	FALSE	FALSE	3.10	9.26	6.24	50%	33%	67%		1.48	6.472903	6.32									16,601	18,195				16,591	18,188		
2/10/2020	FALSE	FALSE	FALSE	3.19	9.50	6.23	51%	34%	66%		1.52	6.475806	6.30									16,601	18,195				16,591	18,188		
2/11/2020	FALSE	FALSE	FALSE	3.14	9.34	6.13	51%	34%	66%		1.52	6.47871	6.27									17,850	17,667				17,839	17,660		
2/12/2020	FALSE	FALSE	FALSE	3.17	9.11	6.20	51%	35%	68%		1.47	6.484194	6.25									17,850	17,667				17,839	17,660		
2/13/2020	FALSE	FALSE	FALSE	3.20	8.97	6.07	53%	36%	68%		1.48	6.485484	6.19									17,850	17,667				17,839	17,660		
2/14/2020	FALSE	FALSE	FALSE	3.24	8.42	6.11	53%	38%	73%		1.38	6.489355	6.17	298.80	221.00	0.74		15,226	11,262			17,475	16,752		15,226	11,262	17,466	16,746		
2/15/2020	FALSE	FALSE	FALSE	3.14	8.57	5.96	53%	37%	70%		1.44	6.482581	6.14									17,099	16,740				17,087	16,732		
2/16/2020	FALSE	FALSE	FALSE	3.11	8.29	5.91	53%	38%	71%		1.40	6.468387	6.11									16,695	16,592				16,681	16,584		
2/17/2020	FALSE	FALSE	FALSE	3.12	9.53	6.28	50%	33%	66%		1.52	6.467419	6.11									16,695	16,592				16,681	16,584		
2/18/2020	FALSE	FALSE	FALSE	3.16	9.34	6.16	51%	34%	66%		1.52	6.467419	6.10									16,695	16,592				16,681	16,584		
2/19/2020	FALSE	FALSE	FALSE	3.13	9.21	6.14	51%	34%	67%		1.50	6.468065	6.10	391.60	357.00	0.91		20,053	18,281			17,254	16,874		20,053	18,281	17,243	16,867		
2/20/2020	FALSE	FALSE	FALSE	3.20	9.13	6.16	52%	35%	67%		1.48	6.457742	6.10	403.40	332.00	0.82		20,724	17,056			17,750	16,900		20,724	17,056	17,741	16,894		
2/21/2020	FALSE	FALSE	FALSE	3.23	8.75	6.06	53%	37%	69%		1.44	6.440968	6.10									17,750	16,900				17,741	16,894		
2/22/2020	FALSE	FALSE	FALSE	3.16	8.38	5.94	53%	38%	71%		1.41	6.42	6.08									18,158	16,703				18,158	16,703		
2/23/2020	FALSE	FALSE	FALSE	3.17	9.22	6.13	52%	34%	66%		1.50	6.406774	6.10									19,406	15,571				19,406	15,571		
2/24/2020	FALSE	FALSE	FALSE	3.17	9.13	6.14	52%	35%	67%		1.49	6.392581	6.13									19,406	15,571				19,406	15,571		
2/25/2020	FALSE	FALSE	FALSE	3.15	9.15	6.00	53%	34%	66%		1.53	6.372581	6.09									19,406	15,571				19,406	15,571		
2/26/2020	FALSE	FALSE	FALSE	3.19	8.98	6.08	52%	36%	68%		1.48	6.314516	6.08	339.00	279.00	0.82		17,190	14,147			19,037	15,334		17,072	14,114	19,017	15,328		
2/27/2020	FALSE	FALSE	FALSE	3.14	9.10	6.03	52%	35%	66%		1.51	6.267097	6.07	312.60	333.00	1.07		15,721	16,747			18,563	15,536		15,721	16,747	18,546	15,531		
2/28/2020	FALSE	FALSE	FALSE	3.25	8.79	6.06	54%	37%	69%		1.45	6.227742	6.06									18,563	15,536				18,546	15,531		
2/29/2020	FALSE	FALSE	FALSE	3.19	8.80	6.05	53%	36%	69%		1.45	6.199677	6.05									18,015	15,104				17,996	15,099		
3/1/2020	FALSE	FALSE	FALSE	3.08	9.22	6.08	51%	33%	66%		1.52	6.179032	6.07									18,015	15,104				17,996	15,099		
3/2/2020	FALSE	FALSE	FALSE	3.03	9.35	6.13	49%	32%	66%		1.53	6.164516	6.07																	

Date	Butte Break?	CSU Break?	Precip?	Min Influent Flow, mgd	Max Influent Flow, mgd	Avg Influent Flow, mgd	Min % of Avg	Min % of Max	Avg % of Max	Flow Outlier Type	Diurnal Peak Factor (DPF)	30-d Avg of Avg Flow, mgd	7-d Avg of Avg Flow, mgd	Influent TSS Conc., mg/L	Influent BOD Conc., mg/L	BOD/TSS Ratio	Influent NH3-N Conc., mg/L	Avg Inf TSS Load, ppd	Avg Inf BOD Load, ppd	Avg Inf NH3 Load, ppd	Load Outlier Type	30-d Avg of TSS Load, ppd	30-d Avg of BOD Load, ppd	30-d Avg of NH3-N Load, ppd	non-SN TSS Load, ppd	non-SN BOD Load, ppd	non-SN NH3 Load, ppd	30-d Avg of non-SN TSS Load, ppd	30-d Avg of non-SN BOD Load, ppd	30-d Avg of non-SN NH3-N Load, ppd
3/12/2020	FALSE	FALSE	FALSE	3.35	8.64	6.22	54%	39%	72%		1.39	6.13129	6.25									17,645	14,524				17,631	14,519		
3/13/2020	TRUE	TRUE	FALSE	3.33	8.54	6.14	54%	39%	72%		1.39	6.131613	6.26	326.30	263.00	0.81		16,709	13,468			17,541	14,392	16,603	13,405		17,516	14,380		
3/14/2020	TRUE	TRUE	FALSE	2.06	8.60	6.08	34%	24%	71%	inAvgMinM	1.41	6.129333	6.25									17,541	14,392				17,516	14,380		
3/15/2020	TRUE	TRUE	TRUE	2.75	8.53	5.95	46%	32%	70%		1.43	6.125333	6.19									17,541	14,392				17,516	14,380		
3/16/2020	TRUE	TRUE	TRUE	3.31	7.73	5.90	56%	43%	76%		1.31	6.118333	6.13									17,831	14,839				17,803	14,825		
3/17/2020	TRUE	TRUE	TRUE	3.59	8.33	6.30	57%	43%	76%		1.32	6.129667	6.13									17,831	14,839				17,803	14,825		
3/18/2020	TRUE	TRUE	TRUE	3.60	8.26	6.32	57%	44%	77%		1.31	6.143333	6.15	290.40	202.00	0.70		15,307	10,647			17,550	14,315	15,307	10,647		17,525	14,303		
3/19/2020	TRUE	TRUE	FALSE	3.43	7.93	6.07	57%	43%	77%		1.31	6.136333	6.13									17,550	14,315				17,525	14,303		
3/20/2020	FALSE	TRUE	FALSE	3.46	7.74	5.95	58%	45%	77%		1.30	6.129333	6.09									17,550	14,315				17,525	14,303		
3/21/2020	FALSE	TRUE	FALSE	3.35	8.19	5.88	57%	41%	72%		1.39	6.120667	6.05									17,238	13,749				17,209	13,735		
3/22/2020	FALSE	TRUE	FALSE	3.30	8.13	5.84	57%	41%	72%		1.39	6.11	6.03									16,739	13,197				16,707	13,181		
3/23/2020	FALSE	TRUE	FALSE	3.40	7.89	6.03	56%	43%	76%		1.31	6.109	6.04									16,739	13,197				16,707	13,181		
3/24/2020	FALSE	FALSE	TRUE	1.83	7.94	6.18	30%	23%	78%	inAvgMinM	1.28	6.114828	6.06									16,739	13,197				16,707	13,181		
3/25/2020	FALSE	FALSE	FALSE	3.42	7.95	6.01	57%	43%	76%		1.32	6.11069	6.01	260.00	316.00	1.22		13,032	15,839			16,276	13,575	13,032	15,839		16,248	13,561		
3/26/2020	FALSE	FALSE	FALSE	3.36	7.92	5.83	58%	42%	74%		1.36	6.1	5.94									16,276	13,575				16,248	13,561		
3/27/2020	FALSE	FALSE	FALSE	3.33	7.72	5.85	57%	43%	76%		1.32	6.094828	5.91									16,276	13,575				16,248	13,561		
3/28/2020	FALSE	FALSE	TRUE	3.35	8.29	5.92	57%	40%	71%		1.40	6.08931	5.91									16,145	13,479				16,130	13,469		
3/29/2020	FALSE	FALSE	TRUE	3.25	8.25	5.85	56%	39%	71%		1.41	6.083103	5.90									16,216	12,826				16,199	12,813		
3/30/2020	FALSE	FALSE	FALSE	3.33	7.71	5.90	56%	43%	77%		1.31	6.077586	5.91									16,216	12,826				16,199	12,813		
3/31/2020	FALSE	FALSE	FALSE	3.37	7.79	5.85	58%	43%	75%		1.33	6.07069	5.89									16,216	12,826				16,199	12,813		
4/1/2020	FALSE	FALSE	FALSE	3.35	7.71	5.76	58%	43%	75%		1.34	6.059655	5.87									16,216	12,826				16,199	12,813		
4/2/2020	FALSE	FALSE	FALSE	3.30	7.91	5.73	58%	42%	72%		1.38	6.045862	5.84	346.50	326.00	0.94		16,559	15,579			16,265	13,285	16,559	15,579		16,250	13,274		
4/3/2020	FALSE	FALSE	FALSE	3.38	7.59	5.71	59%	45%	75%		1.33	6.032414	5.82									16,265	13,285				16,250	13,274		
4/4/2020	FALSE	FALSE	TRUE	3.22	8.78	6.07	53%	37%	69%		1.45	6.03	5.85									16,068	13,285				16,051	13,274		
4/5/2020	FALSE	FALSE	TRUE	3.37	10.53	6.82	49%	32%	65%		1.54	6.054483	5.96									15,794	13,271				15,773	13,259		
4/6/2020	FALSE	FALSE	TRUE	4.00	8.77	6.82	59%	46%	78%		1.29	6.073793	6.08									15,794	13,271				15,773	13,259		
4/7/2020	FALSE	FALSE	TRUE	3.74	8.36	6.38	59%	45%	76%		1.31	6.073103	6.14									15,794	13,271				15,773	13,259		
4/8/2020	FALSE	FALSE	FALSE	3.65	8.28	6.28	58%	44%	76%		1.32	6.071034	6.20									15,794	13,271				15,773	13,259		
4/9/2020	FALSE	FALSE	FALSE	3.56	7.91	6.15	58%	45%	78%		1.29	6.067241	6.25	331.60	234.00	0.71		17,008	12,002			15,997	13,060	17,008	12,002		15,979	13,049		
4/10/2020	FALSE	FALSE	FALSE	3.54	7.63	5.96	59%	46%	78%		1.28	6.058621	6.27	270.20	280.00	1.04		13,431	13,918			15,630	13,182	13,431	13,918		15,615	13,173		
4/11/2020	FALSE	FALSE	FALSE	3.47	8.11	5.95	58%	43%	73%		1.36	6.049655	6.30									15,341	13,575				15,323	13,565		
4/12/2020	FALSE	FALSE	FALSE	3.38	8.21	5.86	58%	41%	71%		1.40	6.037241	6.28									15,341	13,575				15,323	13,565		
4/13/2020	FALSE	FALSE	FALSE	3.41	7.84	5.79	59%	43%	74%		1.35	6.025172	6.15									15,067	13,597				15,067	13,597		
4/14/2020	FALSE	FALSE	FALSE	3.34	7.78	5.80	58%	43%	75%		1.34	6.017667	6.02									15,067	13,597				15,067	13,597		
4/15/2020	FALSE	FALSE	FALSE	3.43	7.66	5.88	58%	45%	77%		1.30	6.015333	5.96	310.80	260.00	0.84		15,241	12,750			15,096	13,456	15,241	12,750		15,096	13,456		
4/16/2020	FALSE	FALSE	FALSE	3.42	7.69	5.89	58%	44%	77%		1.31	6.015	5.91									15,096	13,456				15,096	13,456		
4/17/2020	FALSE	FALSE	FALSE	3.42	7.55	5.85	58%	45%	77%		1.29	6.0	5.87									15,096	13,456				15,096	13,456		
4/18/2020	FALSE	FALSE	FALSE	3.43	7.90	5.88	58%	43%	74%		1.34	5.985333	5.86									15,054	14,018				15,054	14,018		
4/19/2020	FALSE	FALSE	FALSE	3.42	8.13	5.82	59%	42%	72%		1.40	5.977	5.85									15,054	14,018				15,054	14,018		
4/20/2020	FALSE	FALSE	FALSE	3.38	7.75	5.91	57%	44%	76%		1.31	5.975667	5.85									15,054	14,018				15,054	14,018		
4/21/2020	FALSE	FALSE	FALSE	3.38	7.71	5.79	58%	44%	75%		1.33	5.972667	5.85									15,054	14,018				15,054	14,018		
4/22/2020	FALSE	FALSE	FALSE	3.45	7.60	5.79	60%	45%	76%		1.31	5.971	5.85									15,054	14,018				15,054	14,018		
4/23/2020	FALSE	FALSE	FALSE	3.36	7.55	5.76	58%	45%	76%		1.31	5.962	5.84	146.60	282.00	1.92		7,042	13,547			13,719	13,939	7,042	13,547		13,719	13,939		
4/24/2020	FALSE	FALSE	FALSE	3.39	7.38	5.68	60%	46%	77%		1.30	5.952903	5.81									13,719	13,939				13,719	13,939		
4/25/2020	FALSE	FALSE	FALSE	3.34	7.73	5.69	59%	43%	74%		1.36	5.942581	5.79									13,856	13,559				13,856	13,559		
4/26/2020	FALSE	FALSE	FALSE	3.35	7.73	5.71	59%	43%	74%		1.35	5.93871	5.77									13,856	13,559				13,856	13,559		
4/27/2020	FALSE	FALSE	FALSE	3.40	7.45	5.72	59%	46%	77%		1.30	5.934516	5.76									13,856	13,559				13,856	13,559		
4/28/2020	FALSE	FALSE	FALSE	3.41	7.63	5.69	60%	45%	75%		1.34	5.927097	5.73									13,856	13,559				13,856	13,559		
4/29/2020	FALSE	FALSE	FALSE	3.37	7.49	4.78	71%	45%	64%	MinAvg	1.57	5.929667	5.72	317.50	282.00	0.89		12,657	11,242			13,656	13,173	12,657	11,242		13,656	13,173		
4/30/2020	FALSE	FALSE	FALSE	0.00	0.00	0.00				igMinMaxA		5.93069	5.71									13,656	13,173				13,656	13,173		
5/1/2020	FALSE	FALSE	FALSE	5.41	7.22	6.72	81%	75%	93%	igMinMaxA	1.07	5.933571	5.70									13,656	13,173				13,656	13,173		
5/2/2020	FALSE	FALSE	FALSE	3.44	7.86	5.82	59%	44%	74%		1.35	5.935714	5.73									13,656	13,173				13,656	13,173		
5/3/2020	FALSE	FALSE	FALSE	3.29	7.98	5.75	57%	41%	72%		1.39	5.936429	5.74									13,076	12,692				13,076	12,692		
5/4/2020	FALSE	FALSE	FALSE	3.44	7.70	5.80	59%	45%	75%		1.33	5.939643	5.76									13,076	12,692				13,076	12,692		
5/5/2020	FALSE	FALSE	FALSE	3.39	7.64	5.75	59%	44%	75%		1.																			

Date	Butte Break?	CSU Break?	Precip?	Min Influent Flow, mgd	Max Influent Flow, mgd	Avg Influent Flow, mgd	Min % of Avg	Min % of Max	Avg % of Max	Flow Outlier Type	Diurnal Peak Factor (DPF)	30-d Avg of Avg Flow, mgd	7-d Avg of Avg Flow, mgd	Influent TSS Conc., mg/L	Influent BOD Conc., mg/L	BOD/TSS Ratio	Influent NH3-N Conc., mg/L	Avg Inf TSS Load, ppd	Avg Inf BOD Load, ppd	Avg Inf NH3 Load, ppd	Load Outlier Type	30-d Avg of TSS Load, ppd	30-d Avg of BOD Load, ppd	30-d Avg of NH3-N Load, ppd	non-SN TSS Load, ppd	non-SN BOD Load, ppd	non-SN NH3 Load, ppd	30-d Avg of non-SN TSS Load, ppd	30-d Avg of non-SN BOD Load, ppd	30-d Avg of non-SN NH3-N Load, ppd
5/14/2020	FALSE	FALSE	FALSE	3.42	7.70	5.98	57%	44%	78%		1.29	5.788929	5.80	242.90	389.00	1.60		12,114	19,401			12,726	13,738		12,114	19,401		12,726	13,738	
5/15/2020	FALSE	FALSE	FALSE	3.48	7.68	5.80	60%	45%	76%		1.32	5.788929	5.81									12,726	13,738					12,726	13,738	
5/16/2020	FALSE	FALSE	TRUE	3.36	7.86	5.83	58%	43%	74%		1.35	5.787143	5.83									12,097	13,984					12,097	13,984	
5/17/2020	FALSE	TRUE	TRUE	3.63	8.92	6.47	56%	41%	73%		1.38	5.807857	5.94									12,097	13,984					12,097	13,984	
5/18/2020	FALSE	TRUE	TRUE	3.97	8.79	6.84	58%	45%	78%		1.29	5.843214	6.11									12,097	13,984					12,097	13,984	
5/19/2020	FALSE	TRUE	TRUE	3.74	8.37	6.55	57%	45%	78%		1.28	5.867143	6.17									12,097	13,984					12,097	13,984	
5/20/2020	FALSE	TRUE	TRUE	3.97	8.31	6.63	60%	48%	80%		1.25	5.896071	6.26	309.40	293.00	0.95		17,108	16,201			13,099	14,428		16,898	16,127		13,057	14,413	
5/21/2020	FALSE	TRUE	FALSE	3.69	8.25	6.35	58%	45%	77%		1.30	5.911786	6.31									13,099	14,428					13,057	14,413	
5/22/2020	FALSE	TRUE	FALSE	3.55	7.95	6.17	58%	45%	78%		1.29	5.925357	6.33									13,099	14,428					13,057	14,413	
5/23/2020	FALSE	TRUE	FALSE	3.63	7.74	5.89	62%	47%	76%		1.31	5.928929	6.34									13,099	14,428					13,057	14,413	
5/24/2020	FALSE	TRUE	FALSE	3.43	7.50	5.64	61%	46%	75%		1.33	5.924643	6.32									14,614	14,648					14,561	14,629	
5/25/2020	FALSE	TRUE	FALSE	3.65	7.86	5.89	62%	46%	75%		1.33	5.932143	6.25									14,614	14,648					14,561	14,629	
5/26/2020	FALSE	TRUE	FALSE	3.67	7.46	5.91	62%	49%	79%		1.26	5.94	6.13									14,614	14,648					14,561	14,629	
5/27/2020	FALSE	TRUE	FALSE	3.61	7.63	5.97	60%	47%	78%		1.28	5.949286	6.06	272.20	349.00	1.28		13,553	17,377			14,401	15,194		13,553	17,377		14,359	15,179	
5/28/2020	FALSE	TRUE	FALSE	3.89	7.65	6.10	64%	51%	80%		1.25	5.962857	5.99									14,401	15,194					14,359	15,179	
5/29/2020	TRUE	TRUE	FALSE	3.75	7.76	6.14	61%	48%	79%		1.26	5.978929	5.96									14,401	15,194					14,359	15,179	
5/30/2020	TRUE	TRUE	TRUE	3.68	8.08	6.07	61%	46%	75%		1.33	5.982069	5.95									14,838	16,182					14,785	16,163	
5/31/2020	TRUE	TRUE	FALSE	3.60	8.11	6.01	60%	44%	74%		1.35	5.983	5.97									14,838	16,182					14,785	16,163	
6/1/2020	TRUE	TRUE	FALSE	3.65	7.51	5.96	61%	49%	79%		1.26	5.982258	6.01									14,838	16,182					14,785	16,163	
6/2/2020	TRUE	TRUE	FALSE	3.47	7.40	5.79	60%	47%	78%		1.28	5.98129	5.99									14,838	16,182					14,785	16,163	
6/3/2020	TRUE	TRUE	FALSE	3.51	7.57	5.84	60%	46%	77%		1.30	5.984194	5.99	326.40	324.00	0.99		15,898	15,781			15,050	16,101		15,898	15,781		15,007	16,087	
6/4/2020	TRUE	TRUE	FALSE	3.49	7.42	5.81	60%	47%	78%		1.28	5.984516	5.97									15,050	16,101					15,007	16,087	
6/5/2020	TRUE	TRUE	FALSE	3.46	7.52	5.93	58%	46%	79%		1.27	5.990323	5.94									15,050	16,101					15,007	16,087	
6/6/2020	TRUE	TRUE	TRUE	3.49	7.85	5.86	60%	44%	75%		1.34	5.994194	5.91									15,050	16,101					15,007	16,087	
6/7/2020	TRUE	TRUE	FALSE	3.31	7.88	5.73	58%	42%	73%		1.38	5.995806	5.87									14,668	17,190					14,616	17,171	
6/8/2020	TRUE	TRUE	FALSE	3.32	7.41	5.77	58%	45%	78%		1.28	5.997742	5.84									14,668	17,190					14,616	17,171	
6/9/2020	TRUE	TRUE	FALSE	3.53	7.36	5.82	61%	48%	79%		1.26	6.006774	5.82									14,668	17,190					14,616	17,171	
6/10/2020	TRUE	TRUE	FALSE	3.43	7.37	5.77	59%	47%	78%		1.28	6.014194	5.82									14,668	17,190					14,616	17,171	
6/11/2020	TRUE	TRUE	FALSE	3.50	7.40	5.82	60%	47%	79%		1.27	6.008387	5.81	328.80	245.00	0.75		15,960	11,892			14,926	16,130		15,960	11,892		14,884	16,115	
6/12/2020	TRUE	TRUE	TRUE	3.38	7.25	5.94	57%	47%	82%		1.22	6.008387	5.83									14,926	16,130					14,884	16,115	
6/13/2020	TRUE	TRUE	TRUE	2.08	7.69	5.72	36%	27%	74%	MinAvg	1.34	6.009333	5.82									14,926	16,130					14,884	16,115	
6/14/2020	TRUE	TRUE	FALSE	3.37	7.55	5.64	60%	45%	75%		1.34	5.998	5.78									15,629	15,313					15,577	15,294	
6/15/2020	TRUE	TRUE	FALSE	3.44	7.53	5.93	58%	46%	79%		1.27	6.002333	5.81									15,629	15,313					15,577	15,294	
6/16/2020	TRUE	TRUE	FALSE	3.52	7.41	5.75	61%	48%	78%		1.29	5.999667	5.81									15,629	15,313					15,577	15,294	
6/17/2020	TRUE	TRUE	FALSE	3.45	7.39	5.79	60%	47%	78%		1.28	5.977	5.81	334.80	244.00	0.73		16,167	11,782			15,737	14,607		16,167	11,782		15,695	14,592	
6/18/2020	TRUE	TRUE	FALSE	3.42	7.24	5.71	60%	47%	79%		1.27	5.939333	5.80									15,737	14,607					15,695	14,592	
6/19/2020	TRUE	TRUE	FALSE	3.58	7.21	5.77	62%	50%	80%		1.25	5.913333	5.79									15,737	14,607					15,695	14,592	
6/20/2020	TRUE	TRUE	FALSE	3.35	7.47	5.58	60%	45%	75%		1.34	5.878333	5.74									15,394	14,208					15,394	14,208	
6/21/2020	TRUE	TRUE	FALSE	3.31	7.37	5.49	60%	45%	74%		1.34	5.849667	5.71									15,394	14,208					15,394	14,208	
6/22/2020	TRUE	TRUE	FALSE	3.41	7.35	5.78	59%	46%	79%		1.27	5.836667	5.73									15,394	14,208					15,394	14,208	
6/23/2020	TRUE	TRUE	FALSE	3.39	7.37	5.81	58%	46%	79%		1.27	5.834	5.71									15,394	14,208					15,394	14,208	
6/24/2020	TRUE	TRUE	FALSE	3.45	7.33	5.84	59%	47%	80%		1.26	5.840667	5.72	353.50	243.00	0.69		17,217	11,835			15,759	13,733		17,217	11,835		15,759	13,733	
6/25/2020	TRUE	TRUE	FALSE	3.48	7.31	5.79	60%	48%	79%		1.26	5.837333	5.72									15,759	13,733					15,759	13,733	
6/26/2020	TRUE	TRUE	FALSE	3.60	7.20	5.76	63%	50%	80%		1.25	5.832333	5.73									15,759	13,733					15,759	13,733	
6/27/2020	TRUE	TRUE	FALSE	3.47	7.47	5.66	61%	46%	76%		1.32	5.822	5.71									16,310	12,823					16,310	12,823	
6/28/2020	TRUE	TRUE	FALSE	3.35	7.60	5.75	58%	44%	76%		1.32	5.810333	5.74									16,310	12,823					16,310	12,823	
6/29/2020	TRUE	TRUE	FALSE	3.35	7.32	5.79	58%	46%	79%		1.26	5.798667	5.77									16,310	12,823					16,310	12,823	
6/30/2020	TRUE	TRUE	FALSE	3.57	7.33	5.80	62%	49%	79%		1.26	5.789667	5.78									16,310	12,823					16,310	12,823	
7/1/2020	TRUE	TRUE	FALSE	3.49	7.31	5.80	60%	48%	79%		1.26	5.782667	5.77	312.40	150.00	0.48		15,111	7,256			16,071	11,709		15,111	7,256		16,071	11,709	
7/2/2020	TRUE	TRUE	FALSE	3.47	7.25	5.81	60%	48%	80%		1.25	5.777667	5.77									16,071	11,709					16,071	11,709	
7/3/2020	TRUE	TRUE	FALSE	3.48	7.50	5.71	61%	46%	76%		1.31	5.775	5.76									16,071	11,709					16,071	11,709	
7/4/2020	TRUE	TRUE	FALSE	3.41	7.23	5.29	64%	47%	73%		1.37	5.756667	5.70									16,114	10,691					16,114	10,691	
7/5/2020	TRUE	TRUE	FALSE	3.30	7.21	5.34	62%	46%	74%		1.35	5.741	5.66									16,114	10,691					16,114	10,691	
7/6/2020	TRUE	TRUE	FALSE	3.42	7.34	5.80	59%	47%	79%		1.27	5.736667	5.67									16,114	10,691					16,114	10,691	
7/7/2020	TRUE	TRUE	FALSE	3.39	7.32	5.78	59%	46%	79%		1.27	5.734	5.67																	

Date	Butte Break?	CSU Break?	Precip?	Min Influent Flow, mgd	Max Influent Flow, mgd	Avg Influent Flow, mgd	Min % of Avg	Min % of Max	Avg % of Max	Flow Outlier Type	Diurnal Peak Factor (DPF)	30-d Avg of Avg Flow, mgd	7-d Avg of Avg Flow, mgd	Influent TSS Conc., mg/L	Influent BOD Conc., mg/L	BOD/TSS Ratio	Influent NH3-N Conc., mg/L	Avg Inf TSS Load, ppd	Avg Inf BOD Load, ppd	Avg Inf NH3 Load, ppd	Load Outlier Type	30-d Avg of TSS Load, ppd	30-d Avg of BOD Load, ppd	30-d Avg of NH3-N Load, ppd	non-SN TSS Load, ppd	non-SN BOD Load, ppd	non-SN NH3 Load, ppd	30-d Avg of non-SN TSS Load, ppd	30-d Avg of non-SN BOD Load, ppd	30-d Avg of non-SN NH3-N Load, ppd
9/17/2020	FALSE	FALSE	FALSE	3.57	8.10	6.15	58%	44%	76%		1.32	6.10871	6.16	306.30	218.00	0.71		15,710	11,181			15,300	13,022		15,710	11,181		14,957	12,959	
9/18/2020	FALSE	FALSE	FALSE	3.55	7.99	6.23	57%	44%	78%		1.28	6.115484	6.16									15,300	13,022					14,957	12,959	
9/19/2020	FALSE	FALSE	FALSE	3.53	8.22	6.08	58%	43%	74%		1.35	6.114839	6.14									15,018	13,708					15,018	13,708	
9/20/2020	FALSE	FALSE	FALSE	3.39	8.20	6.02	56%	41%	73%		1.36	6.110645	6.13									15,018	13,708					15,018	13,708	
9/21/2020	FALSE	FALSE	FALSE	3.48	8.05	6.17	56%	43%	77%		1.30	6.114516	6.14									15,018	13,708					15,018	13,708	
9/22/2020	FALSE	FALSE	FALSE	3.56	8.24	6.19	58%	43%	75%		1.33	6.119355	6.15									15,018	13,708					15,018	13,708	
9/23/2020	FALSE	FALSE	FALSE	3.59	8.20	6.24	58%	44%	76%		1.31	6.121935	6.16	313.00	232.00	0.74		16,289	12,074			15,272	13,381		16,289	12,074		15,272	13,381	
9/24/2020	FALSE	FALSE	FALSE	3.56	8.20	6.21	57%	43%	76%		1.32	6.122258	6.16									15,272	13,381					15,272	13,381	
9/25/2020	FALSE	FALSE	FALSE	3.50	8.18	6.16	57%	43%	75%		1.33	6.122903	6.16									15,272	13,381					15,272	13,381	
9/26/2020	FALSE	FALSE	FALSE	3.53	8.00	5.98	59%	44%	75%		1.34	6.117419	6.13									15,582	13,803					15,582	13,803	
9/27/2020	FALSE	FALSE	FALSE	3.41	8.33	6.05	56%	41%	73%		1.38	6.114194	6.13									15,582	13,803					15,582	13,803	
9/28/2020	FALSE	FALSE	FALSE	3.45	8.19	6.18	56%	42%	75%		1.33	6.113548	6.15									15,582	13,803					15,582	13,803	
9/29/2020	FALSE	FALSE	FALSE	3.52	8.01	6.10	58%	44%	76%		1.31	6.114516	6.14									15,582	13,803					15,582	13,803	
9/30/2020	FALSE	FALSE	FALSE	3.58	8.24	6.17	58%	43%	75%		1.34	6.117097	6.14	342.20	258.00	0.75		17,609	13,276			15,987	13,698		17,609	13,276		15,987	13,698	
10/1/2020	FALSE	FALSE	FALSE	3.57	8.18	6.20	58%	44%	76%		1.32	6.11871	6.13									15,987	13,698					15,987	13,698	
10/2/2020	FALSE	FALSE	FALSE	3.52	7.92	6.16	57%	44%	78%		1.29	6.122581	6.13									15,987	13,698					15,987	13,698	
10/3/2020	FALSE	FALSE	FALSE	3.55	8.23	6.13	58%	43%	74%		1.34	6.120645	6.12									16,284	13,212					16,284	13,212	
10/4/2020	FALSE	FALSE	FALSE	3.45	8.35	6.09	57%	41%	73%		1.37	6.115484	6.14									16,284	13,212					16,284	13,212	
10/5/2020	FALSE	FALSE	FALSE	3.51	8.22	6.12	57%	43%	74%		1.34	6.113548	6.14									16,284	13,212					16,284	13,212	
10/6/2020	FALSE	FALSE	FALSE	3.50	8.26	6.13	57%	42%	74%		1.35	6.123871	6.14									16,284	13,212					16,284	13,212	
10/7/2020	FALSE	FALSE	FALSE	3.56	8.28	6.19	58%	43%	75%		1.34	6.14129	6.15	247.20	333.00	1.35		12,762	17,191			15,580	14,007		12,762	17,191		15,580	14,007	
10/8/2020	FALSE	FALSE	FALSE	3.60	8.13	6.22	58%	44%	77%		1.31	6.148065	6.16									15,580	14,007					15,580	14,007	
10/9/2020	FALSE	FALSE	FALSE	3.49	8.03	6.20	56%	43%	77%		1.30	6.153226	6.16									15,580	14,007					15,580	14,007	
10/10/2020	FALSE	FALSE	FALSE	3.48	8.31	6.06	57%	42%	73%		1.37	6.147097	6.14									15,592	13,431					15,592	13,431	
10/11/2020	FALSE	FALSE	FALSE	3.39	8.22	6.04	56%	41%	73%		1.36	6.14	6.13									15,592	13,431					15,592	13,431	
10/12/2020	FALSE	FALSE	FALSE	3.41	8.33	6.16	55%	41%	74%		1.35	6.139355	6.14									15,592	13,431					15,592	13,431	
10/13/2020	FALSE	FALSE	FALSE	3.49	8.26	6.12	57%	42%	74%		1.35	6.139355	6.14									15,592	13,431					15,592	13,431	
10/14/2020	FALSE	FALSE	FALSE	3.45	8.07	6.04	57%	43%	75%		1.34	6.136129	6.13	332.00	333.00	1.00		16,724	16,774			15,819	14,099		16,724	16,774		15,819	14,099	
10/15/2020	FALSE	FALSE	FALSE	3.44	8.00	6.07	57%	43%	76%		1.32	6.136774	6.11									15,819	14,099					15,819	14,099	
10/16/2020	FALSE	FALSE	FALSE	3.43	7.75	6.02	57%	44%	78%		1.29	6.131935	6.09									15,819	14,099					15,819	14,099	
10/17/2020	FALSE	FALSE	FALSE	3.45	7.79	5.86	59%	44%	75%		1.33	6.120645	6.05									15,819	14,099					15,819	14,099	
10/18/2020	FALSE	FALSE	FALSE	3.37	8.20	6.01	56%	41%	73%		1.36	6.116129	6.04									15,846	14,829					15,846	14,829	
10/19/2020	FALSE	FALSE	FALSE	3.45	8.33	6.12	56%	41%	73%		1.36	6.112581	6.05									15,846	14,829					15,846	14,829	
10/20/2020	FALSE	FALSE	FALSE	3.41	8.44	6.11	56%	40%	72%		1.38	6.113548	6.04									15,846	14,829					15,846	14,829	
10/21/2020	FALSE	FALSE	FALSE	3.42	8.26	6.12	56%	41%	74%		1.35	6.116774	6.04									15,846	14,829					15,846	14,829	
10/22/2020	FALSE	FALSE	FALSE	3.46	8.06	6.09	57%	43%	76%		1.32	6.114194	6.05	293.50	244.00	0.83		14,907	12,393			15,658	14,342		14,907	12,393		15,658	14,342	
10/23/2020	FALSE	FALSE	FALSE	3.43	7.80	6.09	56%	44%	78%		1.28	6.110968	6.05									15,658	14,342					15,658	14,342	
10/24/2020	FALSE	FALSE	FALSE	3.49	8.27	6.02	58%	42%	73%		1.37	6.103871	6.05									15,500	14,909					15,500	14,909	
10/25/2020	FALSE	FALSE	FALSE	3.40	8.37	6.10	56%	41%	73%		1.37	6.100323	6.08									15,500	14,909					15,500	14,909	
10/26/2020	FALSE	FALSE	FALSE	3.36	8.51	6.15	55%	39%	72%		1.38	6.1	6.10									15,500	14,909					15,500	14,909	
10/27/2020	FALSE	FALSE	FALSE	3.42	8.41	6.14	56%	41%	73%		1.37	6.105161	6.10									15,500	14,909					15,500	14,909	
10/28/2020	FALSE	FALSE	FALSE	3.44	8.44	6.18	56%	41%	73%		1.37	6.109355	6.11									15,500	14,909					15,500	14,909	
10/29/2020	FALSE	FALSE	FALSE	3.50	8.35	6.21	56%	42%	74%		1.34	6.110323	6.12	396.80	288.00	0.73		20,551	14,916			16,510	14,910		20,551	14,916		16,510	14,910	
10/30/2020	FALSE	FALSE	FALSE	3.45	7.95	6.16	56%	43%	77%		1.29	6.112258	6.13									16,510	14,910					16,510	14,910	
10/31/2020	FALSE	FALSE	FALSE	3.43	8.44	6.09	56%	41%	72%		1.39	6.109677	6.13									16,236	15,319					16,236	15,319	
11/1/2020	FALSE	FALSE	FALSE	3.37	8.45	6.07	56%	40%	72%		1.39	6.105484	6.14									16,236	15,319					16,236	15,319	
11/2/2020	FALSE	FALSE	FALSE	3.41	8.32	6.13	56%	41%	74%		1.36	6.104516	6.14									16,236	15,319					16,236	15,319	
11/3/2020	FALSE	FALSE	FALSE	3.41	8.07	6.15	55%	42%	76%		1.31	6.105161	6.14									16,236	15,319					16,236	15,319	
11/4/2020	FALSE	FALSE	FALSE	3.48	8.31	6.21	56%	42%	75%		1.34	6.109032	6.15	281.00	204.00	0.73		14,553	10,565			15,899	14,368		14,553	10,565		15,899	14,368	
11/5/2020	FALSE	FALSE	FALSE	3.47	8.06	6.14	57%	43%	76%		1.31	6.109677	6.15									15,899	14,368					15,899	14,368	
11/6/2020	FALSE	FALSE	FALSE	3.37	7.65	6.09	55%	44%	80%		1.26	6.108387	6.13									15,899	14,368					15,899	14,368	
11/7/2020	FALSE	FALSE	FALSE	3.44	8.48	6.07	57%	41%	72%		1.40	6.104516	6.12									16,684	13,662					16,684	13,662	
11/8/2020	FALSE	FALSE	FALSE	3.26	8.80	6.17	53%	37%	70%		1.43	6.102903	6.13									16,684	13,662					16,684	13,662	
11/9/2020	FALSE	FALSE	FALSE	3.34	8.26	6.19	54%	40%	75%		1.33	6.102581	6.14									16,684	13,662					16,684	13,662	
11/10/2020	FALSE	FALSE	FALSE	3.33	8.10	6.10	55%	41%	75																					

Date	Butte Break?	CSU Break?	Precip?	Min Influent Flow, mgd	Max Influent Flow, mgd	Avg Influent Flow, mgd	Min % of Avg	Min % of Max	Avg % of Max	Flow Outlier Type	Diurnal Peak Factor (DPF)	30-d Avg of Avg Flow, mgd	7-d Avg of Avg Flow, mgd	Influent TSS Conc., mg/L	Influent BOD Conc., mg/L	BOD/TSS Ratio	Influent NH3-N Conc., mg/L	Avg Inf TSS Load, ppd	Avg Inf BOD Load, ppd	Avg Inf NH3 Load, ppd	Load Outlier Type	30-d Avg of TSS Load, ppd	30-d Avg of BOD Load, ppd	30-d Avg of NH3-N Load, ppd	non-SN TSS Load, ppd	non-SN BOD Load, ppd	non-SN NH3 Load, ppd	30-d Avg of non-SN TSS Load, ppd	30-d Avg of non-SN BOD Load, ppd	30-d Avg of non-SN NH3-N Load, ppd
11/19/2020	FALSE	FALSE	FALSE	3.48	8.26	6.22	56%	42%	75%		1.33	6.140968	6.18									13,512	13,003				13,512	13,003		
11/20/2020	FALSE	TRUE	FALSE	3.48	7.82	6.09	57%	45%	78%		1.28	6.140323	6.17									13,512	13,003				13,512	13,003		
11/21/2020	FALSE	TRUE	FALSE	3.44	8.22	6.04	57%	42%	73%		1.36	6.137742	6.16									13,512	13,003				13,512	13,003		
11/22/2020	FALSE	TRUE	FALSE	3.33	8.52	5.98	56%	39%	70%		1.42	6.134194	6.15									13,164	13,156				13,164	13,156		
11/23/2020	FALSE	TRUE	FALSE	3.45	8.40	6.23	55%	41%	74%		1.35	6.13871	6.16									13,164	13,156				13,164	13,156		
11/24/2020	FALSE	TRUE	FALSE	3.53	7.95	6.11	58%	44%	77%		1.30	6.141613	6.16	265.90	236.00	0.89		13,550	12,026			13,241	12,930	13,550	12,026		13,241	12,930		
11/25/2020	TRUE	TRUE	FALSE	3.46	7.90	6.08	57%	44%	77%		1.30	6.140968	6.13									13,241	12,930				13,241	12,930		
11/26/2020	TRUE	TRUE	FALSE	3.41	8.63	5.85	58%	40%	68%		1.48	6.13129	6.08									13,241	12,930				13,241	12,930		
11/27/2020	TRUE	TRUE	FALSE	3.33	7.65	5.57	60%	44%	73%		1.37	6.112903	5.99									13,241	12,930				13,241	12,930		
11/28/2020	TRUE	TRUE	FALSE	3.37	7.84	5.69	59%	43%	73%		1.38	6.097097	5.94									13,241	12,930				13,241	12,930		
11/29/2020	TRUE	TRUE	FALSE	3.27	8.43	6.00	55%	39%	71%		1.41	6.090323	5.94									11,413	12,433				11,413	12,433		
11/30/2020	TRUE	TRUE	FALSE	3.34	8.23	6.04	55%	41%	73%		1.36	6.086452	5.95									11,413	12,433				11,413	12,433		
12/1/2020	FALSE	FALSE	FALSE	3.44	8.23	6.10	56%	42%	74%		1.35	6.086774	5.93									11,413	12,433				11,413	12,433		
12/2/2020	FALSE	FALSE	FALSE	3.43	8.22	6.05	57%	42%	74%		1.36	6.086129	5.92	339.80	298.00	0.88		17,145	15,036			12,560	12,954	17,145	15,036		12,560	12,954		
12/3/2020	FALSE	FALSE	FALSE	3.39	8.08	6.07	56%	42%	75%		1.33	6.084194	5.92									12,560	12,954				12,560	12,954		
12/4/2020	FALSE	FALSE	FALSE	3.41	7.77	6.03	57%	44%	78%		1.29	6.080323	5.94									12,560	12,954				12,560	12,954		
12/5/2020	FALSE	FALSE	FALSE	3.39	8.27	5.94	57%	41%	72%		1.39	6.071613	5.99									12,061	13,551				12,061	13,551		
12/6/2020	FALSE	FALSE	FALSE	3.31	8.45	6.04	55%	39%	71%		1.40	6.068387	6.03									12,061	13,551				12,061	13,551		
12/7/2020	FALSE	FALSE	FALSE	3.42	8.14	6.13	56%	42%	75%		1.33	6.069677	6.05									12,061	13,551				12,061	13,551		
12/8/2020	FALSE	FALSE	FALSE	3.45	8.15	6.05	57%	42%	74%		1.35	6.069032	6.05									12,061	13,551				12,061	13,551		
12/9/2020	FALSE	FALSE	FALSE	3.35	8.02	6.11	55%	42%	76%		1.31	6.067097	6.05	270.00	379.00	1.40		13,758	19,313			12,401	14,703	13,758	19,313		12,401	14,703		
12/10/2020	FALSE	FALSE	FALSE	3.40	7.92	6.08	56%	43%	77%		1.30	6.063548	6.06									12,401	14,703				12,401	14,703		
12/11/2020	FALSE	FALSE	TRUE	3.35	7.96	6.05	55%	42%	76%		1.32	6.061935	6.05									12,401	14,703				12,401	14,703		
12/12/2020	FALSE	FALSE	TRUE	3.42	8.62	6.03	57%	40%	70%		1.43	6.058065	6.05									12,401	14,703				12,401	14,703		
12/13/2020	FALSE	FALSE	TRUE	3.41	9.55	6.45	53%	36%	68%		1.48	6.067742	6.12									13,290	15,148				13,290	15,148		
12/14/2020	FALSE	FALSE	FALSE	3.40	8.24	6.30	54%	41%	76%		1.31	6.071935	6.15									13,290	15,148				13,290	15,148		
12/15/2020	FALSE	FALSE	TRUE	3.50	8.24	6.21	56%	42%	75%		1.33	6.076774	6.16									13,290	15,148				13,290	15,148		
12/16/2020	FALSE	FALSE	TRUE	3.51	7.80	4.86	72%	45%	62%	MinAvg	1.60	6.074333	6.18	279.30	381.00	1.36		11,321	15,443			12,896	15,207	11,321	15,443		12,896	15,207		
12/17/2020	FALSE	FALSE	TRUE	5.39	8.61	7.71	70%	63%	90%	gMinMaxA	1.12	6.072759	6.19									12,896	15,207				12,896	15,207		
12/18/2020	FALSE	TRUE	FALSE	3.56	8.03	6.43	55%	44%	80%		1.25	6.077931	6.25									12,896	15,207				12,896	15,207		
12/19/2020	FALSE	TRUE	FALSE	3.52	8.62	6.20	57%	41%	72%		1.39	6.074828	6.27									13,944	15,454				13,944	15,454		
12/20/2020	TRUE	TRUE	FALSE	3.37	8.60	6.11	55%	39%	71%		1.41	6.071034	6.28									13,944	15,454				13,944	15,454		
12/21/2020	TRUE	TRUE	FALSE	3.44	8.17	6.11	56%	42%	75%		1.34	6.071724	6.23									13,944	15,454				13,944	15,454		
12/22/2020	TRUE	TRUE	FALSE	3.33	7.87	6.05	55%	42%	77%		1.30	6.072069	6.19	290.70	262.00	0.90		14,668	13,220			14,088	15,008	14,668	13,220		14,088	15,008		
12/23/2020	TRUE	TRUE	FALSE	3.42	7.89	6.00	57%	43%	76%		1.32	6.072759	6.15									14,088	15,008				14,088	15,008		
12/24/2020	TRUE	TRUE	FALSE	3.44	8.47	5.91	58%	41%	70%		1.43	6.061724	6.12									14,088	15,008				14,088	15,008		
12/25/2020	TRUE	TRUE	TRUE	3.32	7.17	5.29	63%	46%	74%		1.36	6.033448	6.01									14,223	15,753				14,223	15,753		
12/26/2020	TRUE	TRUE	TRUE	3.35	7.77	5.65	59%	43%	73%		1.38	6.018621	5.92									14,223	15,753				14,223	15,753		
12/27/2020	TRUE	TRUE	FALSE	3.32	8.20	5.82	57%	40%	71%		1.41	6.017586	5.87									14,223	15,753				14,223	15,753		
12/28/2020	TRUE	TRUE	FALSE	3.39	8.10	5.99	57%	42%	74%		1.35	6.032069	5.85									14,223	15,753				14,223	15,753		
12/29/2020	TRUE	TRUE	FALSE	3.32	7.64	5.89	56%	43%	77%		1.30	6.038966	5.83									14,223	15,753				14,223	15,753		
12/30/2020	TRUE	TRUE	TRUE	3.39	7.93	5.96	57%	43%	75%		1.33	6.037586	5.81	300.30	204.00	0.68		14,927	10,140			14,364	14,630	14,927	10,140		14,364	14,630		
12/31/2020	TRUE	TRUE	FALSE	3.46	7.93	5.95	58%	44%	75%		1.33	6.034483	5.81									14,364	14,630				14,364	14,630		
1/1/2021	TRUE	TRUE	FALSE	3.43	7.73	5.59	61%	44%	72%		1.38	6.016897	5.77									14,364	14,630				14,364	14,630		
1/2/2021	TRUE	TRUE	TRUE	3.32	8.02	5.72	58%	41%	71%		1.40	6.005517	5.82									13,668	14,529				13,668	14,529		
1/3/2021	TRUE	TRUE	TRUE	3.33	8.58	6.01	55%	39%	70%		1.43	6.003448	5.87									13,668	14,529				13,668	14,529		
1/4/2021	TRUE	TRUE	TRUE	3.48	8.54	6.43	54%	41%	75%		1.33	6.017241	5.94									13,668	14,529				13,668	14,529		
1/5/2021	TRUE	TRUE	FALSE	3.59	8.36	6.27	57%	43%	75%		1.33	6.028621	5.98	237.90	265.00	1.11		12,440	13,857			13,423	14,395	12,440	13,857		13,423	14,395		
1/6/2021	TRUE	TRUE	TRUE	3.52	8.15	6.24	56%	43%	77%		1.31	6.035517	6.02									13,423	14,395				13,423	14,395		
1/7/2021	TRUE	TRUE	FALSE	3.39	8.16	6.19	55%	42%	76%		1.32	6.037586	6.05									13,423	14,395				13,423	14,395		
1/8/2021	TRUE	TRUE	TRUE	3.55	7.95	6.06	59%	45%	76%		1.31	6.037931	6.06									13,423	14,395				13,423	14,395		
1/9/2021	TRUE	TRUE	FALSE	3.38	8.31	6.02	56%	41%	72%		1.38	6.034828	6.12									13,339	13,165				13,339	13,165		
1/10/2021	TRUE	TRUE	FALSE	3.35	8.40	6.06	55%	40%	72%		1.39	6.034138	6.16									13,339	13,165				13,339	13,165		
1/11/2021	TRUE	TRUE	FALSE	3.39	8.13	6.07	56%	42%	75%		1.34	6.034828	6.17									13,339	13,165				13,339	13,165		
1/12/2021	TRUE	TRUE	FALSE	3.44	8.01	6.04	57%	43%	75%		1.33	6.035172</																		

Date	Butte Break?	CSU Break?	Precip?	Min Influent Flow, mgd	Max Influent Flow, mgd	Avg Influent Flow, mgd	Min % of Avg	Min % of Max	Avg % of Max	Flow Outlier Type	Diurnal Peak Factor (DPF)	30-d Avg of Avg Flow, mgd	7-d Avg of Avg Flow, mgd	Influent TSS Conc., mg/L	Influent BOD Conc., mg/L	BOD/TSS Ratio	Influent NH3-N Conc., mg/L	Avg Inf TSS Load, ppd	Avg Inf BOD Load, ppd	Avg Inf NH3 Load, ppd	Load Outlier Type	30-d Avg of TSS Load, ppd	30-d Avg of BOD Load, ppd	30-d Avg of NH3-N Load, ppd	non-SN TSS Load, ppd	non-SN BOD Load, ppd	non-SN NH3 Load, ppd	30-d Avg of non-SN TSS Load, ppd	30-d Avg of non-SN BOD Load, ppd	30-d Avg of non-SN NH3-N Load, ppd
1/21/2021	TRUE	TRUE	FALSE	3.44	8.04	6.04	57%	43%	75%		1.33	5.970323	5.98									14,053	11,919				14,053	11,919		
1/22/2021	TRUE	TRUE	TRUE	3.47	7.86	6.05	57%	44%	77%		1.30	5.970323	5.98									13,899	11,594				13,899	11,594		
1/23/2021	TRUE	TRUE	FALSE	3.38	8.12	5.91	57%	42%	73%		1.37	5.967419	5.98									13,899	11,594				13,899	11,594		
1/24/2021	TRUE	TRUE	TRUE	3.32	8.79	6.16	54%	38%	70%		1.43	5.975484	6.01									13,899	11,594				13,899	11,594		
1/25/2021	TRUE	TRUE	TRUE	3.32	8.32	6.19	54%	40%	74%		1.34	6.004516	6.05									13,899	11,594				13,899	11,594		
1/26/2021	FALSE	FALSE	TRUE	3.44	8.54	6.25	55%	40%	73%		1.37	6.023871	6.07									13,899	11,594				13,899	11,594		
1/27/2021	FALSE	FALSE	TRUE	4.05	9.57	7.19	56%	42%	75%		1.33	6.068065	6.22	284.60	214.00	0.75		17,066	12,832			14,533	11,841	17,066	12,832		14,533	11,841		
1/28/2021	FALSE	FALSE	TRUE	5.06	10.68	8.23	61%	47%	77%		1.30	6.140323	6.50									14,533	11,841				14,533	11,841		
1/29/2021	FALSE	FALSE	TRUE	4.77	10.23	7.92	60%	47%	77%		1.29	6.205806	6.74									14,533	11,841				14,533	11,841		
1/30/2021	FALSE	FALSE	FALSE	4.11	9.39	7.10	58%	44%	76%		1.32	6.242581	6.87									14,434	12,267				14,434	12,267		
1/31/2021	FALSE	FALSE	FALSE	3.68	9.16	6.82	54%	40%	74%		1.34	6.270645	6.98									14,434	12,267				14,434	12,267		
2/1/2021	FALSE	FALSE	TRUE	3.74	9.47	6.75	55%	39%	71%		1.40	6.308065	7.06									14,434	12,267				14,434	12,267		
2/2/2021	FALSE	FALSE	TRUE	4.62	9.80	7.67	60%	47%	78%		1.28	6.370968	7.24	218.40	337.00	1.54		13,971	21,557			14,341	14,125	13,971	21,557		14,341	14,125		
2/3/2021	FALSE	FALSE	FALSE	4.08	9.41	7.22	57%	43%	77%		1.30	6.41	7.36									14,341	14,125				14,341	14,125		
2/4/2021	FALSE	FALSE	FALSE	3.80	8.92	6.82	56%	43%	76%		1.31	6.422581	7.32									14,341	14,125				14,341	14,125		
2/5/2021	FALSE	FALSE	FALSE	3.81	8.60	6.55	58%	44%	76%		1.31	6.431613	7.11									14,817	14,192				14,817	14,192		
2/6/2021	FALSE	FALSE	FALSE	3.73	8.58	6.47	58%	43%	75%		1.33	6.439032	6.93									14,817	14,192				14,817	14,192		
2/7/2021	FALSE	FALSE	FALSE	3.52	8.83	6.34	56%	40%	72%		1.39	6.443871	6.83									14,817	14,192				14,817	14,192		
2/8/2021	FALSE	FALSE	FALSE	3.53	8.51	6.37	55%	41%	75%		1.34	6.453871	6.77									14,817	14,192				14,817	14,192		
2/9/2021	FALSE	FALSE	FALSE	3.52	8.47	6.25	56%	42%	74%		1.36	6.46129	6.71	218.40	363.00	1.66		11,384	18,921			14,130	15,138	11,384	18,921		14,130	15,138		
2/10/2021	FALSE	FALSE	FALSE	3.57	8.35	6.25	57%	43%	75%		1.34	6.467419	6.53									14,130	15,138				14,130	15,138		
2/11/2021	FALSE	FALSE	TRUE	3.57	8.71	6.48	55%	41%	74%		1.34	6.480645	6.44									14,130	15,138				14,130	15,138		
2/12/2021	FALSE	FALSE	TRUE	3.85	8.41	6.62	58%	46%	79%		1.27	6.499355	6.42									14,130	15,138				14,130	15,138		
2/13/2021	FALSE	FALSE	TRUE	3.75	9.07	6.61	57%	41%	73%		1.37	6.517742	6.42									13,749	16,466				13,749	16,466		
2/14/2021	FALSE	FALSE	FALSE	3.56	9.05	6.49	55%	39%	72%		1.39	6.532903	6.43									13,749	16,466				13,749	16,466		
2/15/2021	FALSE	FALSE	TRUE	3.63	9.20	6.72	54%	39%	73%		1.37	6.557419	6.47									13,749	16,466				13,749	16,466		
2/16/2021	FALSE	FALSE	FALSE	3.72	8.77	6.64	56%	42%	76%		1.32	6.582258	6.51									13,749	16,466				13,749	16,466		
2/17/2021	FALSE	FALSE	FALSE	3.62	8.74	6.46	56%	41%	74%		1.35	6.60129	6.53	245.40	224.00	0.91		13,221	12,068			13,643	15,587	13,221	12,068		13,643	15,587		
2/18/2021	FALSE	FALSE	FALSE	3.62	8.37	6.44	56%	43%	77%		1.30	6.612258	6.56									13,643	15,587				13,643	15,587		
2/19/2021	FALSE	FALSE	TRUE	3.59	8.24	6.37	56%	44%	77%		1.29	6.623548	6.54									13,643	15,587				13,643	15,587		
2/20/2021	FALSE	FALSE	FALSE	3.51	8.35	6.17	57%	42%	74%		1.35	6.630645	6.49									13,910	16,345				13,910	16,345		
2/21/2021	FALSE	FALSE	FALSE	3.36	8.47	6.23	54%	40%	74%		1.36	6.636774	6.44									13,910	16,345				13,910	16,345		
2/22/2021	FALSE	FALSE	FALSE	3.49	8.44	6.21	56%	41%	74%		1.36	6.641935	6.41									13,910	16,345				13,910	16,345		
2/23/2021	FALSE	FALSE	FALSE	3.46	8.64	6.18	56%	40%	72%		1.40	6.650645	6.34	266.00	347.00	1.30		13,710	17,885			13,870	16,653	13,710	17,885		13,870	16,653		
2/24/2021	FALSE	FALSE	FALSE	3.45	8.59	6.20	56%	40%	72%		1.39	6.651935	6.28									13,870	16,653				13,870	16,653		
2/25/2021	FALSE	FALSE	FALSE	3.36	8.36	6.13	55%	40%	73%		1.36	6.65	6.24									13,870	16,653				13,870	16,653		
2/26/2021	FALSE	FALSE	FALSE	3.40	8.16	6.08	56%	42%	75%		1.34	6.644516	6.20									13,870	16,653				13,870	16,653		
2/27/2021	FALSE	FALSE	FALSE	3.25	8.13	5.92	55%	40%	73%		1.37	6.603548	6.14									13,071	17,608				13,071	17,608		
2/28/2021	FALSE	FALSE	FALSE	3.25	8.50	6.04	54%	38%	71%		1.41	6.532903	6.12									13,071	17,608				13,071	17,608		
3/1/2021	FALSE	FALSE	FALSE	3.36	8.39	6.09	55%	40%	73%		1.38	6.473871	6.11									13,071	17,608				13,071	17,608		
3/2/2021	FALSE	FALSE	FALSE	3.41	8.41	6.03	57%	41%	72%		1.39	6.439355	6.08	324.00	260.00	0.80		16,294	13,075			13,716	16,701	16,294	13,075		13,716	16,701		
3/3/2021	FALSE	FALSE	FALSE	3.46	8.40	6.13	56%	41%	73%		1.37	6.417097	6.08									13,716	16,701				13,716	16,701		
3/4/2021	FALSE	FALSE	FALSE	3.44	8.24	6.10	56%	42%	74%		1.35	6.396129	6.07									13,716	16,701				13,716	16,701		
3/5/2021	FALSE	FALSE	FALSE	3.44	8.24	6.10	56%	42%	74%		1.35	6.345484	6.06									13,652	15,487				13,652	15,487		
3/6/2021	FALSE	FALSE	TRUE	3.52	8.29	6.08	58%	42%	73%		1.36	6.30871	6.06									13,652	15,487				13,652	15,487		
3/7/2021	FALSE	FALSE	FALSE	3.29	8.39	6.10	54%	39%	73%		1.38	6.285484	6.08									13,652	15,487				13,652	15,487		
3/8/2021	FALSE	FALSE	FALSE	3.46	8.18	6.18	56%	42%	76%		1.32	6.273548	6.10									13,652	15,487				13,652	15,487		
3/9/2021	FALSE	FALSE	TRUE	3.44	8.35	6.20	55%	41%	74%		1.35	6.264839	6.12	249.20	477.00	1.91		12,886	24,665			13,499	17,323	12,886	24,665		13,499	17,323		
3/10/2021	FALSE	FALSE	TRUE	3.52	8.50	6.52	54%	41%	77%		1.30	6.270645	6.18									13,499	17,323				13,499	17,323		
3/11/2021	FALSE	FALSE	FALSE	3.45	8.40	6.27	55%	41%	75%		1.34	6.267419	6.19									13,499	17,323				13,499	17,323		
3/12/2021	TRUE	TRUE	FALSE	3.52	8.18	6.14	57%	43%	75%		1.33	6.263871	6.20									14,028	16,923				14,028	16,923		
3/13/2021	TRUE	TRUE	FALSE	3.45	8.14	5.91	58%	42%	73%		1.38	6.252903	6.18									14,028	16,923				14,028	16,923		
3/14/2021	TRUE	TRUE	TRUE	3.34	8.62	6.10	55%	39%	71%		1.41	6.240645	6.18									14,028	16,923				14,028	16,923		
3/15/2021	TRUE	TRUE	TRUE	3.82	8.64	6.71	57%	44%	78%		1.29	6.243548	6.25									14,028	16,923				14,028	16,923		
3/16/2021	TRUE	TRUE	FALSE	3.80	8.53	6.42	59%	45%	75%		1.33	6.237419	6.28	246.50	285.00	1.16		13,198												

Date	Butte Break?	CSU Break?	Precip?	Min Influent Flow, mgd	Max Influent Flow, mgd	Avg Influent Flow, mgd	Min % of Avg	Min % of Max	Avg % of Max	Flow Outlier Type	Diurnal Peak Factor (DPF)	30-d Avg of Avg Flow, mgd	7-d Avg of Avg Flow, mgd	Influent TSS Conc., mg/L	Influent BOD Conc., mg/L	BOD/TSS Ratio	Influent NH3-N Conc., mg/L	Avg Inf TSS Load, ppd	Avg Inf BOD Load, ppd	Avg Inf NH3 Load, ppd	Load Outlier Type	30-d Avg of TSS Load, ppd	30-d Avg of BOD Load, ppd	30-d Avg of NH3-N Load, ppd	non-SN TSS Load, ppd	non-SN BOD Load, ppd	non-SN NH3 Load, ppd	30-d Avg of non-SN TSS Load, ppd	30-d Avg of non-SN BOD Load, ppd	30-d Avg of non-SN NH3-N Load, ppd
3/25/2021	FALSE	FALSE	FALSE	3.67	8.74	6.49	57%	42%	74%		1.35	6.323871	6.77									14,314	17,244				14,314	17,244		
3/26/2021	FALSE	FALSE	FALSE	3.55	8.57	6.28	57%	41%	73%		1.36	6.327097	6.70									14,465	17,083				14,465	17,083		
3/27/2021	FALSE	FALSE	FALSE	3.63	8.52	6.17	59%	43%	72%		1.38	6.326129	6.53									14,465	17,083				14,465	17,083		
3/28/2021	FALSE	FALSE	FALSE	3.45	8.40	6.13	56%	41%	73%		1.37	6.326129	6.45									14,465	17,083				14,465	17,083		
3/29/2021	FALSE	FALSE	FALSE	3.58	8.36	6.30	57%	43%	75%		1.33	6.333226	6.41									14,465	17,083				14,465	17,083		
3/30/2021	FALSE	FALSE	FALSE	3.42	8.38	6.17	55%	41%	74%		1.36	6.341229	6.34	351.40	270.00	0.77		18,082	13,894			15,189	16,445	18,082	13,894		15,189	16,445		
3/31/2021	FALSE	FALSE	FALSE	3.65	8.27	6.20	59%	44%	75%		1.33	6.346452	6.29									15,189	16,445				15,189	16,445		
4/1/2021	FALSE	FALSE	FALSE	3.48	8.24	6.10	57%	42%	74%		1.35	6.346774	6.23									15,189	16,445				15,189	16,445		
4/2/2021	FALSE	FALSE	FALSE	3.53	8.00	6.17	57%	44%	77%		1.30	6.35129	6.19									14,912	17,288				14,912	17,288		
4/3/2021	FALSE	FALSE	FALSE	3.53	8.16	6.00	59%	43%	74%		1.36	6.347097	6.16									14,912	17,288				14,912	17,288		
4/4/2021	FALSE	FALSE	FALSE	3.31	8.34	5.91	56%	40%	71%		1.41	6.340968	6.12									14,912	17,288				14,912	17,288		
4/5/2021	FALSE	FALSE	FALSE	3.40	8.37	6.07	56%	41%	73%		1.38	6.34	6.12									14,912	17,288				14,912	17,288		
4/6/2021	FALSE	FALSE	FALSE	3.45	8.24	6.11	56%	42%	74%		1.35	6.340968	6.09									14,912	17,288				14,912	17,288		
4/7/2021	FALSE	FALSE	FALSE	3.54	8.30	6.14	58%	43%	74%		1.35	6.342258	6.09	110.40	549.00	4.97		5,653	28,113			13,060	19,453	5,653	28,113		13,060	19,453		
4/8/2021	FALSE	FALSE	FALSE	3.46	8.26	6.13	56%	42%	74%		1.35	6.340645	6.08									13,060	19,453				13,060	19,453		
4/9/2021	FALSE	FALSE	FALSE	3.59	8.00	6.10	59%	45%	76%		1.31	6.337419	6.08									13,104	18,150				13,104	18,150		
4/10/2021	FALSE	FALSE	FALSE	3.54	8.12	5.94	60%	44%	73%		1.37	6.31871	6.05									13,104	18,150				13,104	18,150		
4/11/2021	FALSE	FALSE	FALSE	3.43	8.23	6.00	57%	42%	73%		1.37	6.31	6.05									13,104	18,150				13,104	18,150		
4/12/2021	FALSE	FALSE	FALSE	3.55	8.22	6.09	58%	43%	74%		1.35	6.308387	6.07									13,104	18,150				13,104	18,150		
4/13/2021	FALSE	FALSE	FALSE	3.51	8.25	6.08	58%	43%	74%		1.36	6.313871	6.07	317.90	256.00	0.81		16,120	12,981			13,707	17,116	16,120	12,981		13,707	17,116		
4/14/2021	FALSE	FALSE	FALSE	3.45	8.31	6.10	57%	42%	73%		1.36	6.313871	6.07									13,707	17,116				13,707	17,116		
4/15/2021	FALSE	FALSE	FALSE	3.61	8.26	6.11	59%	44%	74%		1.35	6.294516	6.07									13,707	17,116				13,707	17,116		
4/16/2021	FALSE	FALSE	FALSE	3.54	7.98	6.07	58%	44%	76%		1.31	6.283226	6.06									13,834	17,580				13,834	17,580		
4/17/2021	FALSE	FALSE	FALSE	3.48	7.90	5.88	59%	44%	74%		1.34	6.270968	6.03									13,834	17,580				13,834	17,580		
4/18/2021	FALSE	FALSE	FALSE	3.37	8.16	5.90	57%	41%	72%		1.38	6.239677	6.03									13,834	17,580				13,834	17,580		
4/19/2021	FALSE	FALSE	FALSE	3.53	8.00	6.04	58%	44%	76%		1.32	6.193548	6.03									13,834	17,580				13,834	17,580		
4/20/2021	FALSE	FALSE	FALSE	3.50	8.07	5.99	58%	43%	74%		1.35	6.167419	6.02	301.20	238.00	0.79		15,047	11,890			14,077	16,442	15,047	11,890		14,077	16,442		
4/21/2021	FALSE	FALSE	FALSE	3.64	8.15	6.13	59%	45%	75%		1.33	6.15129	6.03									14,077	16,442				14,077	16,442		
4/22/2021	FALSE	FALSE	FALSE	3.72	8.19	6.16	60%	45%	75%		1.33	6.132581	6.04									14,077	16,442				14,077	16,442		
4/23/2021	FALSE	FALSE	FALSE	3.47	7.75	6.05	57%	45%	78%		1.28	6.115161	6.03									13,726	16,719				13,726	16,719		
4/24/2021	FALSE	FALSE	FALSE	3.55	7.96	5.97	59%	45%	75%		1.33	6.096129	6.02									13,726	16,719				13,726	16,719		
4/25/2021	FALSE	FALSE	TRUE	3.48	8.51	6.18	56%	41%	73%		1.38	6.086129	6.05									13,726	16,719				13,726	16,719		
4/26/2021	FALSE	FALSE	FALSE	3.48	8.18	6.21	56%	43%	76%		1.32	6.083871	6.09									13,726	16,719				13,726	16,719		
4/27/2021	FALSE	FALSE	FALSE	3.42	8.14	6.07	56%	42%	75%		1.34	6.080645	6.10	348.10	260.00	0.75		17,622	13,162			14,505	16,008	17,622	13,162		14,505	16,008		
4/28/2021	FALSE	FALSE	FALSE	3.59	8.16	6.02	60%	44%	74%		1.36	6.077097	6.10									14,505	16,008				14,505	16,008		
4/29/2021	FALSE	FALSE	FALSE	3.67	7.98	6.00	61%	46%	75%		1.33	6.067419	6.08									14,505	16,008				14,505	16,008		
4/30/2021	FALSE	FALSE	FALSE	3.62	7.75	6.04	60%	47%	78%		1.28	6.063226	6.07									13,611	16,536				13,611	16,536		
5/1/2021	FALSE	FALSE	FALSE	0.00	0.00	0.00						5.863226	5.31									13,611	16,536				13,611	16,536		
5/2/2021	FALSE	FALSE	FALSE	0.00	0.00	0.00						5.666452	4.57									13,611	16,536				13,611	16,536		
5/3/2021	FALSE	FALSE	FALSE	0.00	0.00	0.00						5.467419	3.79									13,611	16,536				13,611	16,536		
5/4/2021	FALSE	FALSE	FALSE	0.00	0.00	0.00						5.273871	3.02									13,611	16,536				13,611	16,536		
5/5/2021	FALSE	FALSE	FALSE	0.00	0.00	0.00						5.083226	2.26									13,611	16,536				13,611	16,536		
5/6/2021	FALSE	FALSE	FALSE	0.00	0.00	0.00						4.887419	1.51									13,611	16,536				13,611	16,536		
5/7/2021	FALSE	FALSE	FALSE	0.00	0.00	0.00						4.690323	0.76									13,611	16,536				13,611	16,536		
5/8/2021	FALSE	FALSE	FALSE	0.00	0.00	0.00						4.492258	0.00									16,263	12,678				16,263	12,678		
5/9/2021	FALSE	FALSE	FALSE	0.00	0.00	0.00						4.294516	0.00									16,263	12,678				16,263	12,678		
5/10/2021	FALSE	FALSE	FALSE	0.00	0.00	0.00						4.097742	0.00									16,263	12,678				16,263	12,678		
5/11/2021	FALSE	FALSE	FALSE	0.00	0.00	0.00						3.906129	0.00									16,263	12,678				16,263	12,678		
5/12/2021	FALSE	FALSE	FALSE	0.00	0.00	0.00						3.712581	0.00									16,263	12,678				16,263	12,678		
5/13/2021	FALSE	FALSE	FALSE	0.00	0.00	0.00						3.516129	0.00									16,263	12,678				16,263	12,678		
5/14/2021	FALSE	FALSE	FALSE	0.00	0.00	0.00						3.32	0.00									16,335	12,526				16,335	12,526		
5/15/2021	FALSE	FALSE	FALSE	0.00	0.00	0.00						3.123226	0.00									16,335	12,526				16,335	12,526		
5/16/2021	FALSE	FALSE	FALSE	0.00	0.00	0.00						2.926129	0.00									16,335	12,526				16,335	12,526		
5/17/2021	FALSE	FALSE	FALSE	0.00	0.00	0.00						2.730323	0.00									16,335	12,526				16,335	12,526		
5/18/2021	FALSE	FALSE	FALSE	0.00	0.00	0.00						2.540645	0.00									16,335	12,526				16,335	12,526		
5/19/2021	FALSE	FALSE	FALSE	0.00	0.00	0.00						2.350323	0.00									16,335	12,526				16,335	12,526		
5/20/2021	FALSE	FALSE	FALSE	0.00	0.00	0.00						2.155484	0.00																	

Date	Butte Break?	CSU Break?	Precip?	Min Influent Flow, mgd	Max Influent Flow, mgd	Avg Influent Flow, mgd	Min % of Avg	Min % of Max	Avg % of Max	Flow Outlier Type	Diurnal Peak Factor (DPF)	30-d Avg of Avg Flow, mgd	7-d Avg of Avg Flow, mgd	Influent TSS Conc., mg/L	Influent BOD Conc., mg/L	BOD/TSS Ratio	Influent NH3-N Conc., mg/L	Avg Inf TSS Load, ppd	Avg Inf BOD Load, ppd	Avg Inf NH3 Load, ppd	Load Outlier Type	30-d Avg of TSS Load, ppd	30-d Avg of BOD Load, ppd	30-d Avg of NH3-N Load, ppd	non-SN TSS Load, ppd	non-SN BOD Load, ppd	non-SN NH3 Load, ppd	30-d Avg of non-SN TSS Load, ppd	30-d Avg of non-SN BOD Load, ppd	30-d Avg of non-SN NH3-N Load, ppd
5/27/2021	FALSE	TRUE	FALSE	0.00	0.00	0.00						0.778387	0.00									17,622	13,162				17,622	13,162		
5/28/2021	TRUE	TRUE	FALSE	0.00	0.00	0.00						0.582581	0.00									#DIV/0!	#DIV/0!				#DIV/0!	#DIV/0!		
5/29/2021	TRUE	TRUE	FALSE	0.00	0.00	0.00						0.388387	0.00									#DIV/0!	#DIV/0!				#DIV/0!	#DIV/0!		
5/30/2021	TRUE	TRUE	FALSE	0.00	0.00	0.00						0.194839	0.00									#DIV/0!	#DIV/0!				#DIV/0!	#DIV/0!		
5/31/2021	TRUE	TRUE	FALSE	0.00	0.00	0.00						0	0.00									#DIV/0!	#DIV/0!				#DIV/0!	#DIV/0!		

INSURANCE REQUIREMENTS

Town shall comply with the following insurance requirements unless the City specifically approves a deviation in writing:

1. Prior to the commencement of any construction work for the Project, Town shall procure and maintain in force the following coverages through the term of the IMA and provide the City with the appropriate certificate of insurance/memorandum of coverage and related documents.

1.1 Commercial General Liability Insurance. A commercial general liability insurance or equivalent with limits not less than:

1.1.1 Each Occurrence: \$5,000,000

1.1.2 General Aggregate: \$5,000,000

1.1.3 Products/Completed Operations Aggregate: \$5,000,000

1.1.4 Personal Injury: \$5,000,000

Town may utilize an excess liability policy (following form coverage) to meet the required limits of coverage. Insurance deductibles greater than [\$25,000] must be declared on the certificate of insurance and are subject to approval by the City.

The City must be named as an additional insured party. Additional insured endorsement ISO Form CG2010 11 85 or equivalent form must be attached to the certificate of insurance evidencing completed operations coverage in order to be valid.

The policy or coverage must contain a waiver of subrogation in favor of all additional insureds. Any waiver of subrogation must be endorsed by the contractor's general liability insurance company on ISO Form CG 24 04 10/93 "Waiver of Transfer of Rights of Recovery Against Others to Us" or its equivalent.

Coverage afforded must be primary and non-contributing with any other insurance coverage maintained by the additional insured parties and the policy must provide for severability of interests. The severability of interest clause must state: "the term 'insured' is hereby used severally and not collectively, but the inclusion herein of more than one insured shall not operate to increase the limits of the insurer's liability."

1.2 Automobile Liability. A police of automobile liability insurance having a combined single limit of at least \$1,000,000. The policy must name the City as an additional insured party. Coverage must provide for the loading and unloading of vehicles and liabilities arising out of the use of hired and/or non-owned vehicles.

1.3 Worker's Compensation. Workers compensation insurance as required by applicable state law for employees engaged in work at any job site or operation. The policy must provide a waiver of subrogation in favor of the City. Such waiver of subrogation must be

endorsed by the workers compensation insurance company. In addition, employers liability insurance must be provided in amounts not less than:

- 1.3.1 \$1,000,000 Each Accident for Bodily Injury by Accident
- 1.3.2 \$1,000,000 Policy Limit for Bodily Injury by Disease
- 1.3.3 \$1,000,000 Each Employee for Bodily Injury by Disease

1.4 Pollution Liability. Pollution/environmental liability insurance with limits of \$2,000,000 covering liability arising from the sudden and accidental release of pollution on or near the sites of the Project or Regional Facilities.

2. Town shall provide proof of insurance to the City.

2.1 Commencing with the construction work. Insurance may be satisfied by the contractor.

2.2 The certificate of insurance for the City will be made to:

Certificate Holder:

Address:

3. Town must maintain the required insurance continuously during the effectiveness of this Agreement. However, Town's liabilities under this Agreement are not limited in any manner to the insurance coverage required. Insurance is to be maintained with insurers having at least an A-VII or greater policyholder's rating in accordance with the current A. M. Best Rating Guide, or equivalent insurer rating service. In addition, any and all insurers must be authorized to conduct business in the State of California.

4. Each required insurance policy must be endorsed to state that coverage will not be suspended, voided, cancelled, reduced in coverage or limits except after a 30 day prior written notice, 10 days for non-payment of premium, has been submitted to the City.

5. Town is responsible to pay the insurance deductibles required by its policies. If the City directs Town to pay the insurance deductible, Town shall do so promptly and in accordance with policy requirements.

6. Town's contractors shall provide equivalent coverage. Any waiver of subrogation must be endorsed by the contractor's general liability insurance company on ISO Form CG 24 04 10/93 "Waiver of Transfer of Rights of Recovery Against Others to Us" or its equivalent. Coverage must provide for the loading and unloading of vehicles and liabilities arising out of the use of hired and/or non-owned vehicles.